

02/2019

VVA VERLAG  
Cologne /Germany



# EXTRUSION INTERNATIONAL

AN INTERVIEW  
WITH THE OWNER

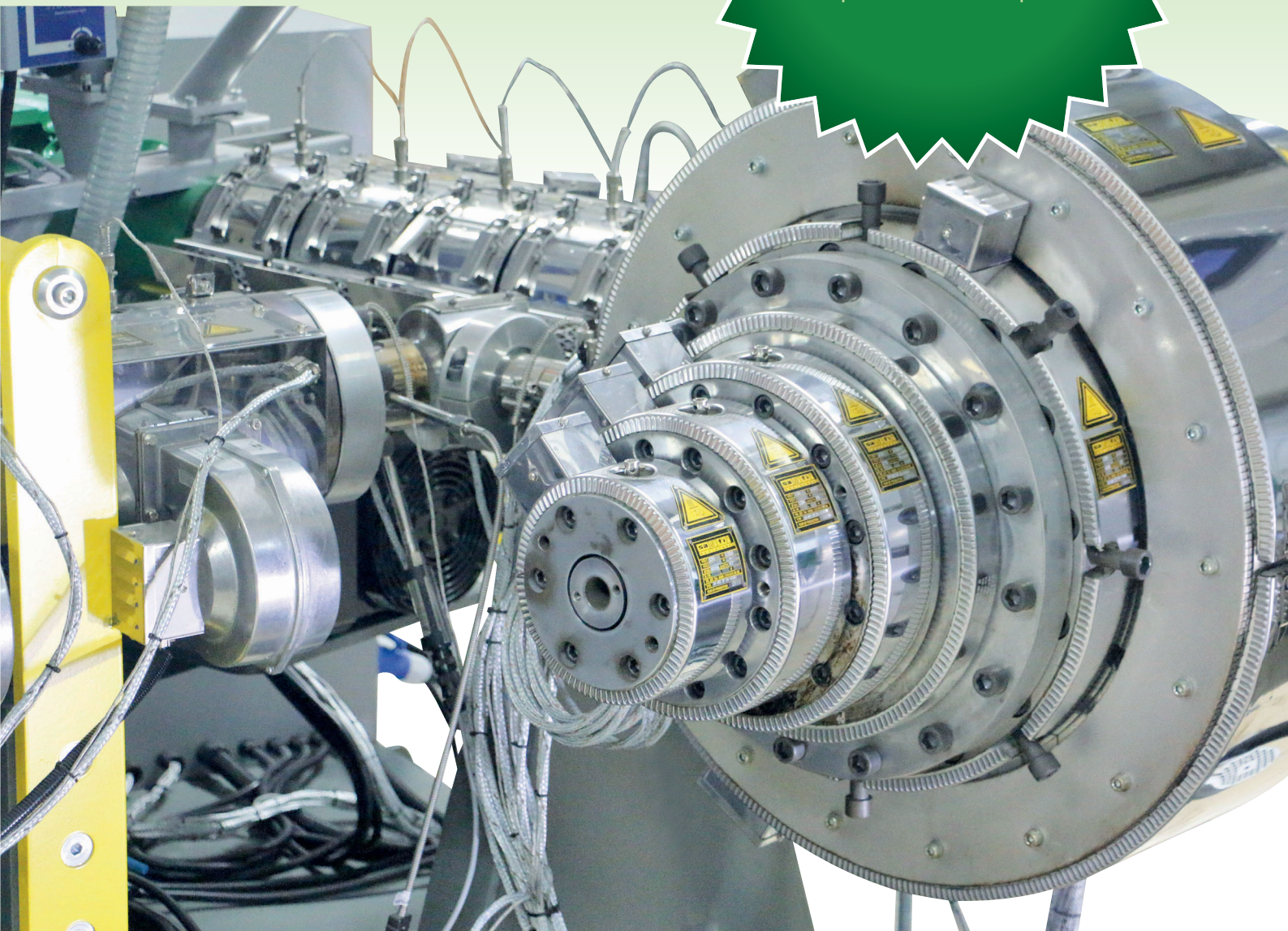





## Recycling problems? Not any more!



"PCL" separation combination: feeder (right), blade unit (centre) with several replaceable cutting blades, haul-off unit (left). The caterpillar pairs are fitted with standard pads like the ones generally used in profile production.

You know the problem. Cassettes of window profiles pile up with sharpened sealing lips or co-extruded top layers since recycling of this material bond has previously been very complex.

### "PCL" non-cutting separation combination for unmixed RECYCLING of window profiles

This new STEIN machine generation solves the problem by moving the profile past specifically arranged stationary blades and cutting off the undesirable material components in the process. A pre-set blade block is locked in place for each profile type in order to reduce the set-up time.

You ultimately get an unmixed profile that constitutes about 80% of the original extrudate and can be 100% fed back into the production process after grinding.

Another new  
and patented  
innovation!

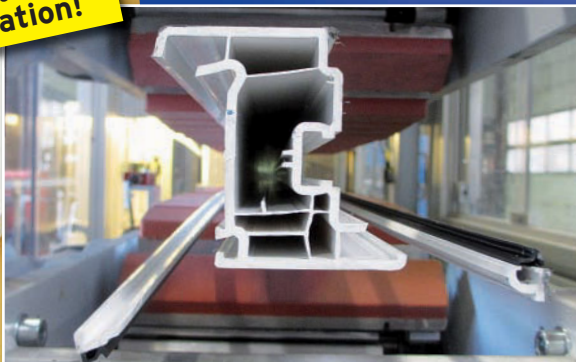

This new STEIN machine is easy on resources, saves material, storage costs and time-consuming sawing of window profiles and speeds up recycling.

A detailed description is available on request. You will be impressed with the functionality!

The non-cutting separated parts on the left and right stand out. The centre picture shows the unmixed profile that can be fed back into the production process.

# in Extrusion

## RAZ and RAZR caterpillar haul-off unit (pivoted)

The STEIN caterpillar haul-off units are suitable for removing a very wide variety of profiles with horizontal pads or high pads. The new patented **PIVOTED RAZR caterpillar haul-off unit**, first exhibited at the 2013 K Trade Fair, is continuously adjustable from 0-90 degrees, does not need any form pads and makes fast profile change possible.

The function of the caterpillar haul-off units with their innovative details:

- ✓ The pre-stretched double chains do not prevent any other elongation during operation. The chains are supported by high-molecular anti-friction material that can be easily changed.
- ✓ The lower caterpillar guide is permanently connected to the machine base. The upper caterpillar can be guided sturdily upwards on the infeed and discharge sides. The contact pressure is ensured by a precision controller with adjustment of the back pressure to relieve weight.
- ✓ The innovative **TILT LOCK** is designed to be supported on the next pad part, thus preventing tilting even with high pads. They can be quickly replaced via a quick-release lock.
- ✓ The caterpillar haul-off unit can be pivoted 90 degrees so that the upright extruded profile on the even surface can be removed. There is thus no need to change the pads (see image on right).
- ✓ The specific drive concept provides optimal **anti-slip control** that minimises wear and tear of pads even when critical profiles are used. No need to worry any more about pad imprints. This type of control guarantees optimum production conditions since both caterpillar speeds align.

**STEIN MASCHINENBAU** arrived in the future long ago! Use this innovation to give you a competitive edge.

**„STEIN BLUE-LINE - for a sustainable future“ stands for sustainable and energy-efficient equipment. Nearly 100% domestic production and high vertical integration guarantee maximum demand.**



Pivoted RAZR caterpillar haul-off unit

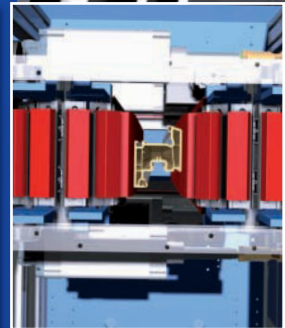

Pad with tilt lock



# STEIN

Maschinenbau GmbH & Co. KG

Wartbachstr. 9 · D-66999 Hinterweidenthal/Germany  
Tel. +49/63 96/92 15-0, Fax +49/63 96/92 15-25  
stein@stein-maschinenbau.de · www.stein-maschinenbau.de



Made in  
Germany



Hall 16,  
Booth F15

Firms in this issue	6	GN Thermoforming: We are pleased with trend towards environmentally friendly solutions	27
Imprint	7	Tecnova: Russia is an interesting yet special market	27
<b>Industry News</b>	8	MIXACO: It is Time to Develop Russian Market	28
Calendar	8	Friul Filiere: We are a company that is a step ahead	29
K 2019 Düsseldorf: New Technologies as Drivers of Innovation for a Productive and Responsible Today, Tomorrow and Future	8	Ilhne & Tesch: Russian Customers understand Technical Thinking of our Company	29
ICE Europe 2019: Record for Exhibition Space, Exhibitor and Visitor Numbers	11	<b>Pipe Extrusion – Interview</b>	
CHINAPLAS 2019 to highlight Circular Economy	12	Being Self-Employed in the Extrusion Industry for 10 Years – A Conclusion	30
Plast Eurasia Istanbul 2019	13	<b>Asiamold 2019</b>	
Festive Inauguration in India	14	The 13th Asiamold witnessed an Outstanding Attendance Increase	32
Group Continues to Grow	14	Connecting Bright Minds	33
Management Team strengthened	16	<b>Measurement Technology</b>	
Acquisition	16	Using Measuring Technique to its Full Potential	34
Acquisition	17	<b>Extrusion Technology</b>	
Market Study: Rigid Plastic Packaging – World	18	Larger Capacities in Europe and Asia	35
Remote Service	18	<b>Measurement Technology</b>	
Growing Recycling Market	19	All Components in View – Measure Any Offshore Flexible	36
Efficient Automation	20	<b>Quality Inspection of Plastics</b>	
Seven-Layer Line	20	Inline Inspection System with Pioneering Technology	38
Reinforcement for 100 % Food Grade PET Business	21	<b>Measurement Technology</b>	
Co-Extrusion Crosshead for Irrigation Tubing	22	Inline Measurement of the Inner Cross-Section Geometry of Extruded Products	40
Battery Separator Film Production	22	<b>Recycling of PET</b>	
Vibrarion Bottom – Easy to Clean	23	Ultra-Fine Microperforation sets New Standards in Melt Filtration	42
New COLORex™ Color Mixer	24	<b>Thermoforming</b>	
New Form, Cut, Stack Thermoformer for Medium-Volume Packaging Production developed	24	Pressure Former for Hygienic and Cost-effective Production of PP Packaging	44
Breakthrough Hybrid Evaporative Cooling System launched	25	<b>Packaging Films – From the Research</b>	
Precise Control of Temperature Process	25	Safer Food – Less Waste	46
<b>Interplastica 2019 – Russia’s Economy is Picking Up</b>	26		
Interviews:	27		



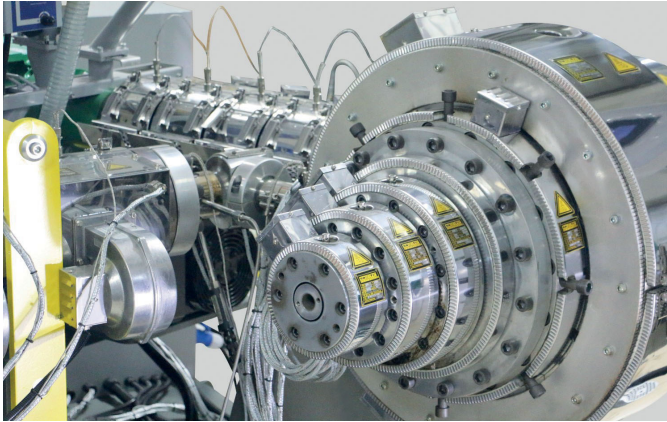

**30** Josef Dobrowsky did not know where his journey would lead him when he first started his own engineering office. Nowadays anything else is unimaginable for him

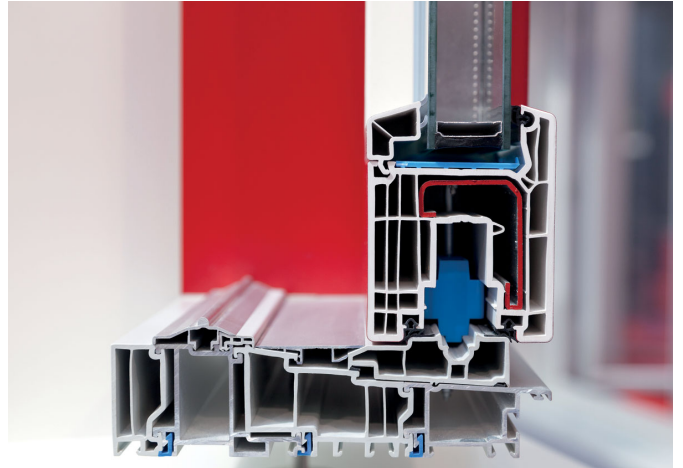

**40** Measurement of inner cross-section geometry with ProfilControl 7 ICSM: New inline system from Pixargus is the first to also measure the rate of recycled material



**44** At IndiaPlast ILLIG showed the latest RV 53d pressure former with 3 bar support for high output of perfect thin-walled thermoformed parts out of i.e. PP, PS or PET

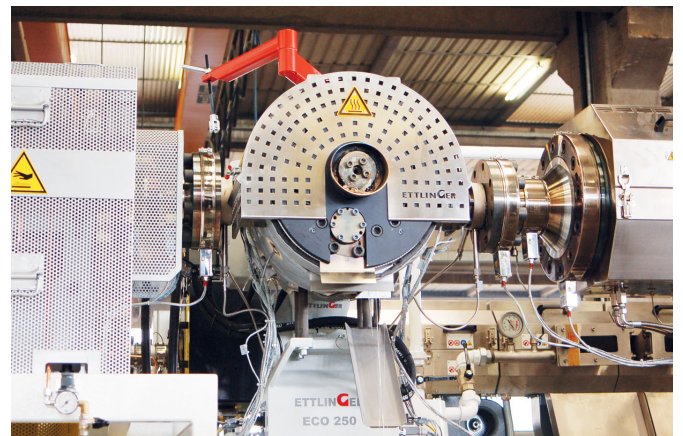

**42** With unprecedented filtration fineness of 60 µm, Ettlinger's ECO melt filters will in the future make it easier to treat recycled material for the film, packaging tape and fiber industry

**46** At ICE Europe 2019, the Fraunhofer Institutes IAP, IGB and FEP presented innovative technologies for sustainable food packaging. They each have extensive expertise in processing, process development and control, the development of special polymer films and the deposition of ultra-thin layers for the packaging industry

**35** The Italian SIMPLAS offers larger capacities in the production and service of dies for film and sheet extrusion. The tool manufacturing facilities of the Austrian partner – Greiner Extrusion in Austria, the Czech Republic and China are used as platforms



## Index of Advertisers, companies and *fairs* referred in this issue

<i>Adsale</i> .....	12	<i>K 2019</i> .....	8
AMUT .....	21	Kiefel .....	20
<i>Asiamold</i> .....	32	KraussMaffei Group .....	16
AZO .....	23	<b>Maag</b> .....	<b>19, 24</b>
Brückner Maschinenbau .....	22	Mack Brooks .....	11
B&R .....	25	Mesago Messe Frankfurt .....	33
Ceresana .....	18	Mixaco .....	28
Chinaplas 2019 .....	12	<b>motan-colortronic</b> .....	<b>17</b>
<b>CONEXTRU</b> .....	<b>23, 30, Outside Cover</b>	motan holding .....	14
Davis-Standard .....	20	Pixargus .....	40
EREMA .....	14	<b>PLAS MEC</b> .....	<b>13</b>
Ettlinger .....	42	Plast Eurasia Istanbul .....	13
Fraunhofer-Institut FEP .....	46	Plastics Recyclers Europe .....	19
Friul Filiere .....	29	Pultrex .....	16
GN Thermoforming .....	23, 27	Reifenhäuser Blown Film .....	17
Greiner Extrusion .....	35	Sikora .....	34
Guill .....	21, 22	Simplas .....	35
<i>ICE Europe 2019</i> .....	11	<b>Smart-Extrusion</b> .....	<b>Outside Back Cover</b>
Ihne & Tesch .....	29	<b>Stein Maschinenbau</b> .....	<b>Inside Front Cover+3</b>
ILLIG .....	44	Tecnova .....	27
INOEX .....	15	Thermal Care .....	25
interplastica 2019 .....	26	<b>Weber, Hans</b> .....	<b>9+10</b>
<b>IPTF 2019</b> .....	<b>Inside Back Cover</b>	Windmüller & Hölscher .....	18
ISRA VISION .....	38	<b>ZUMBACH</b> .....	36
<b>Jwell</b> .....	7		

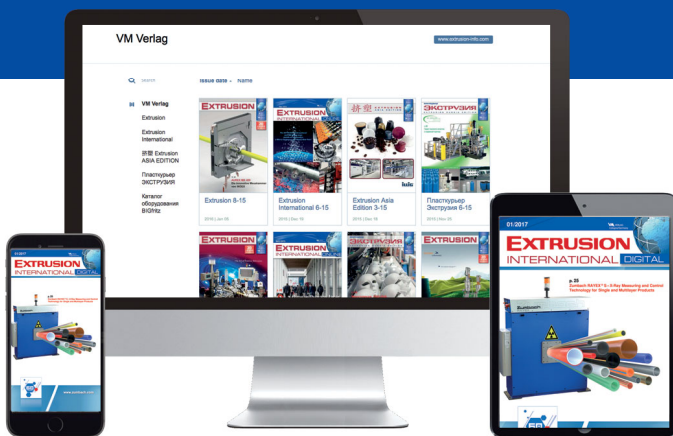

**Subscribe  
for a year  
free of charge!**

Annual subscription to the digital magazine

**Extrusion International**

- **Free of charge**
- **Just** leave your **e-mail address**. No spam. Your data is safe
- Get **immediate notifications** when new issues are published and read online

**www.plastic.expert**





The Extrusion International Digital/Print Magazine is published bimonthly by VM Verlag GmbH. P.O.Box 501812, D- 50879 Cologne, Germany

**EDITORS**

Bettina Jopp-Witt (Editor-in-chief)  
Tel. +49 221 546 1539  
redaktion@vm-verlag.com

Dmitry Kosuch  
Tel. +7 996 730 0113  
d.kosuch@vm-verlag.com

**ADVERTISING SALES**

Martina Lerner  
Tel.:+49 6226 971515  
lerner-media@t-online.de

**ADMINISTRATION**

Alla Kravets  
Tel. +49 2233 949 8793  
a.kravets@vm-verlag.com

**PRINTING**

h-mailconcept e.K.  
directmarketing  
Venloer Str. 1271, Cologne, Germany

**SALES REPRESENTATIVES**

Quaini Pubblicita (Milano IT)  
Tel. +39 02 39216180  
grquaini@tin.it

Worldwide Services Co., Ltd.,  
(TAIWAN)  
Tel. +886-4-2325-1784  
global@acw.com.tw

Tokyo PR Inc. (Japan)  
Tel. +81 (3) 3273-2731  
extrusion@tokyopr.co.jp

**Reprints, Translation etc**

No part of this publication may be reproduced, stored in a retrieval system, or transmitted, in any form or by any means, electronic, mechanical, photographic, recording or otherwise, without prior permission of the publisher.

[www.extrusion-info.com](http://www.extrusion-info.com)



**PP Honeycomb Board Extrusion Line**

**Double Wall Corrugated Pipe Extrusion Line**

**SPC Calcium-plastic Environmental Floor Extrusion Line**

**SHANGHAI JWELL MACHINERY CO.,LTD.**  
Add:No.111 Chun Yi Road,Jia Ding District., Shanghai  
Tel: 86-21-69591818 69591111

[www.jwell.cn](http://www.jwell.cn)  
[sales@jwell.cn](mailto:sales@jwell.cn)



#### CHINAPLAS 2019

21. - 24. 05. 2019  
Guangzhou / P.R. China  
Adsale Exhibition Services Ltd.  
[www.ChinaplasOnline.com](http://www.ChinaplasOnline.com)

#### bio!PAC – biobased materials for packaging

28. - 29. 05. 2019  
Dusseldorf / Germany  
[www.bio-pac.info](http://www.bio-pac.info)

#### Plastpol 2019

28. - 31. 05. 2019  
Kielce / Poland  
[www.plastpol.com](http://www.plastpol.com)

#### Biobased Coatings Europe 2019

19. - 20. 06. 2019  
Dusseldorf / Germany  
Active Communications International  
(ACI Europe)  
[www.wplgroup.com/aci/event/biobased-coatings-europe](http://www.wplgroup.com/aci/event/biobased-coatings-europe)

#### K' 2019

16. - 23. 10. 2019  
Dusseldorf / Germany  
Messe Düsseldorf GmbH  
[www.k-online.de](http://www.k-online.de)

#### Central Asia Plast World

20. - 22. 10. 2019  
Almaty / Kazakhstan  
[www.plastworld.kz](http://www.plastworld.kz)

#### Plastics Recyclers

21. - 22. 11. 2019  
Brussels / Belgium  
[www.plasticsrecyclersam.org](http://www.plasticsrecyclersam.org)

#### Plast Eurasia

04. - 07. 12. 2019  
Istanbul / Turkey  
[www.plasteurasia.com](http://www.plasteurasia.com)

## K 2019 Düsseldorf New technologies as drivers of innovation for a productive and responsible today, tomorrow and future

■ K 2019 – from 16 to 23 October 2019 in Düsseldorf, Germany – is fully booked. Over 3000 exhibitors from more than 60 countries have registered to participate. K will occupy the entire Düsseldorf exhibition grounds with some 175,000 m<sup>2</sup> of net exhibition space, and more than 200,000 trade visitors from all over the world are expected come to the event.

K is the performance barometer for the entire industry and its global marketplace for innovations. For eight days, the “Who’s Who” of the entire plastics and rubber world will meet here to demonstrate the industry’s capabilities, discuss current trends and set the course for the future. K 2019 underscores its special position not only through its popularity with the global industry but also by addressing the current challenges of our era and especially of its sector, first and foremost in regard to “plastics for sustainable development” and the “circular economy”. These not only will be among the hot topics touched on at the exhibitors’ stands at the upcoming K but will also be covered comprehensively in the supporting programme.

For example, the special exhibition “Plastics Shape the Future” also sees itself as a podium for solutions and answers to current social trends and discussions. Crucial topics will be discussed in detail, including packaging waste, marine litter and climate change on the one hand and resource conservation, energy efficiency and recycling on the other. “Plastics Shape the Future” not only will offer an international information and networking platform but will also provide for greater involvement of policymakers and socially relevant groups in the form of keynote speeches and speed talks.

The Science Campus of K 2019 stands for the dialogue between science and industry, with sustainability and recycling management also being examined intensively. Last but not least, the joint appearance of VDMA (German Engineering Federation) and its member companies will also be focused this time on the topic of the circular economy.

(Photo: Messe Düsseldorf, Constanze Tillmann)





power from Maschinenfabrik WEBER.  
Make a great start with even more

**unique**

technology

**High**

also makes the

Performance series NE 40 D particularly energy-efficient!

Increase of up to 40%. The  
which guarantee an output

What you need? **More Power**. WEBER have developed the High Performance series NE 40 D especially for the production of polyolefin pipes. It **offers** four powerful extruder models





NE 5.40

# The NE 40 D series:

Maximum performance for polyolefin pipe extrusion

WEBER have been building grooved bush extruders for more than five decades. A unique High Performance range was developed especially for extrusion of HDPE and PP pipes.

## Advantages

- // Long service life of grooved bush and processing unit through lower grooved bush pressure
- // Constant output across the entire speed range
- // Lowered melting temperature compared to older machine concepts
- // Output increase by up to 40 per cent
- // Reduction of energy consumption
- // Reduced water cooling of the grooved bush and new drive concept (WEBER GREEN TECHNOLOGY)
- // Torque motor optional



Scan code and  
download data sheets  
[extrudertechnologie.de/  
en/pipe](http://extrudertechnologie.de/en/pipe)



## ICE Europe 2019: Record for Exhibition Space, Exhibitor and Visitor Numbers

■ From 12 to 14 March 2019, the international converting industry gathered for the 11th ICE Europe at the Munich Trade Fair Centre in Germany. This year, the World's Leading Exhibition for the conversion of flexible, web-based materials, such as paper, film, foil and nonwovens, achieved higher numbers of exhibitors and visitors than ever before and also set a record for the exhibition space. A total of 7,150 visitors from 75 countries came to the Bavarian capital to discover machinery, systems, materials, and accessories; which is an increase of visitors by 4% compared to the previous event. A total of 463 exhibitors from 25 countries presented their latest technologies on a net exhibition space of 11,500 m<sup>2</sup>, setting records with an 8% increase in exhibitor numbers and a 4% increase in net exhibition space compared to the previous event. The majority of visitors of ICE Europe 2019 came from Germany, Italy, Austria, Poland, Switzerland, Spain, Great Britain, the Netherlands, the Czech Republic, and China. The most important exhibitor countries were Germany, Italy, Great Britain, Switzerland, and the United States.

### ICE Awards 2019:

For the second time, the organisers Mack Brooks Exhibitions honoured best practice, excellence, innovation and outstanding achievements of exhibitors with the ICE Awards, in four categories. Nicola Hamann, Managing Director of Mack Brooks Exhibitions, presented the ICE Awards 2019 to four exhibiting companies on the first day of the show. The winners had previously been determined via an online voting on the show website.



In the category "Digital Converting Solutions" the company JHT GmbH received an award for their vacuum roller system "VacuFI3X", an additively manufactured modular system. Active-assisted, air-driven separation-zones and optimised vacuum-zone-geometries facilitate the detachment and gentle handling of sensitive materials and enable contactless web deflection.

In the category 'Sustainable Products and Manufacturing Processes', the company Nepata GmbH won the ICE Award for its DL1650 film separator, which separates self-adhesive film from its carrier paper. It is the first machine to perform automatic delamination, thus, making it possible to obtain recyclable, pure PVC from faulty film media. The company Derichs GmbH won the ICE Award in the category 'Efficient Production Solutions' for its ED touchless-clean, an innovative solution for the inline-cleaning of different roller surfaces. It uses a newly developed, dielectrically impeded plasma (DBD – dielectric barrier discharge) and facilitates smooth production processes, minimises downtime costs, and optimises workplace safety. The companies OPTIMA life science GmbH und Coatema Coating Machinery GmbH won the ICE Award for their jointly developed machine COMEDCO in the category 'Special Film Innovations'. COMEDCO facilitates intelligent coating, drying, cutting, rolling and packaging processes of transdermal dressings and oral dispersible films. ICE Europe 2021 will take place from 9 to 11 March 2021 at the Munich Trade Fair Centre in Germany.



## CHINAPLAS 2019 to highlight Circular Economy

May 21-24, 2019,  
Guangzhou, PR China

■ Technological innovation, on one hand, favours the acceleration of modern development as well as changes in various markets, while on the other, is driven by the latter two. CHINAPLAS, the Asia's No. 1 plastics and rubber trade fair, being a prominent platform for innovative technology and communication, is highly responsive to the needs and the trends, and always brings in new elements, perpetually providing energy to the plastics and rubber industries. This year, CHINAPLAS highlights circular economy. To foster circular economy is a global consensus and is a major Chinese economic and social development strategy to achieve sustainable development. As such, great potential and bounteous market opportunities arise with it.

Big names adopt Recycled Plastics for appealing benefits: The modeling of big brands has massive influence on the implementation of circular economy, and more and more big names have announced their environmental protection policies of recycling. In 2017, Adidas sold 1 million pairs of running shoes made of ocean plastic waste. It plans to stop using new plastics by 2024 when only recycled plastics will be used as raw materials. Kraft Heinz announced that by 2025, 100% of their packaging will be recyclable, reusable or compostable. Leading companies such as Coca-Cola, Unilever, Volvo, IKEA, Nike, and H&M have also announced plans to use recycled plastics.

The core of circular economy is the efficient use and recycling of resources, and plastic waste recycling is an indispensable part. It is predicted that by 2025, China, one of the world's largest waste plastics recycling countries, will produce urban solid waste amounting to nearly a quarter of the world's total. And we know that by improving the

*"Recycling Technology Zone" was set up since 2016 and this topic will be promoted to a prime position at CHINAPLAS 2019*



*An estimated total of more than 3,500 industrial leaders from around the world will be showcasing their products and solutions in over 250,000 square meters of exhibition space to at least 180,000 professional visitors from 150 countries and regions*

recycling rate of waste plastics, the development of a circular economy can be greatly promoted.

Renewable resource recovery system reforms in light of raw materials shortage: The market is huge, but raw materials are scarce, for first, the "Implementation Plan on Advancing Reform of the Administration System on Import of Solid Wastes through Prohibiting Import of Foreign Rubbish" was launched in 2017. According to statistics, waste plastics imported into China amounted to 7.3 million tons in 2016. Being worth 3.7 billion US dollars, it accounted for 56% of the world's total imports of waste plastics. In the past, the waste processing and recycling industry relied heavily on imports, lacking a complete recycling chain, while recycling rate and proportion of large-scale recycling are both low. With the implementation of the ban, it is bound to intensify the shortage of raw materials, and the recycling system of renewable resources is in urgent need of change.

Plastics Recycling & Circular Economy Conference and Showcase: In addition to upgrading the Recycling Technology Zone, a Plastics Recycling & Circular Economy Conference will also be organized at CHINAPLAS 2019, in order to facilitate mastery of advanced technology, promote technological innovation, and help the industry seize new opportunities. The entire industry chain, from policies and regulations, through recycling technologies to back-end innovative applications, will be analyzed and explained in depth and thoroughly by experts in the industry. Industrial trends, opportunities, challenges, and solutions will also be discussed.



## Plast Eurasia Istanbul 2019

December 4 - 7, 2019,  
Istanbul, Turkey

■ The 28th International Istanbul Plastics Industry Fair brought together 1.094 companies and company representatives from 44 countries and 51.684 professional visitors from 103 countries on the 5th-8th of December 2018. Plastics machinery, chemicals&raw materials, machinery&auxiliary industry, heat&control equipment, mould, hydraulic&pneumatic, recycling, professional publications and other systems were exhibited in 10 halls where national pavilions took place from China, India, Iran and Taiwan. In support of Republic of Turkey Ministry of Trade and Tuyap Overseas offices procurement committees from 34 countries were hosted in Tuyap. Thanks to intensive marketing activities abroad, 7.974 international visitors visited the fair with a 17% increase compared to last year.

According to the online visitor surveys conducted after the fair, 91% of the visitors said they were satisfied with the fair and 93% said they would visit the fair again this year.



Tuyap Fairs and Exhibitions Organization Inc., PAGEV  
[plasteurasia.com/en](http://plasteurasia.com/en)

**plasmec**  
Excellence in Mixing

For over **50 years** a landmark  
in the international market  
for the **manufacturing**  
of **complete mixing plants**

PVC DRY BLEND - POWDER COATINGS  
MASTERBATCH AND PIGMENTS - THERMOPLASTIC RUBBER  
WOOD PLASTIC COMPOSITES

PLAS MEC S.R.L. - Via Europa, 79  
21015 Lonate Pozzolo (VA) ITALY - Tel: +39 0331 301648  
E-mail: [comm@plasmec.it](mailto:comm@plasmec.it) - [www.plasmec.it](http://www.plasmec.it)



**COMPOUNDING**  
WORLD EXPO  
Cleveland, Ohio, USA / May 8-9, 2019

**Chinaplas**  
2019.5.21-24  
Guangzhou, PR China

Stand A220

Hall 4.1  
Stand T35



## Festive Inauguration in India

■ motan-colortronic India Private Limited, a wholly owned subsidiary of the motan group moved to their modern larger premises in Chennai, India. In the presence of Karin Stoll, the Consul General for the Federal Republic of Germany, the new company building was festively inaugurated.

"With the move to the larger building we have tripled our production and storage space and have increased our product portfolio. Now, we not only cover the increasing demand for high quality peripheral units and systems, but also provide shorter delivery times", explains Srikanth Padmanabhan, Managing Director of motan-colortronic Plastics Machinery India Private Limited. "Also, with the new products we can now also serve additional segments such as extrusion and compounding."



*At the opening ceremony of the new motan-colortronic site in India, from left to right: Srikanth Padmanabhan (Managing Director of motan-colortronic Plastics Machinery India Private Limited), Karin Stoll (Consul General for the Federal Republic of Germany in Chennai) and Sandra Füllsack (CEO of motan group)*

In the presence of Mrs. Karin Stoll, the Consul General for the Federal Republic of Germany in Chennai and Mr. T. R. Gopalan, the Regional Director of the Indo-German Chamber of Commerce Chennai, Mrs. Füllsack, CEO of motan group, inaugurated the new production and distribution building with a celebratory speech, which made clear that the quality standard "made by motan" is being realized globally. The local suppliers play a big part in this and they, as well as the other guests, then had the opportunity to view the new building. Exhibited units and the new METROVAC SG blower station were explained and illustrated by the employees. Sandra Füllsack talked about commitment in India at the inauguration: "For a long time we have been convinced that India is the market of the future. Increasing wages and increasing demand for quality products will not only lead to an increase in plastics consumption, but will also provide new potential for automated production processes and thus also for motan. It was always our goal to be on site when the market is ready for our products. With the expansion of our production and the additional expansion of our sales network we are at the right place at the right time."

With the move to the larger building in 2019, the motan group is once again expanding their presence in India. Since 1993 motan products have been produced in India through a technology collaboration agreement. 1998 a Liaison Office was opened, and in 2009 a wholly owned production and distribution center was founded in Chennai, India. Chennai is located on the Bay of Bengal in eastern India.

■ motan holding gmbh  
www.motan-colortronic.com

## Group Continues to Grow

■ The EREMA Group celebrates the most successful business year in the company's history. Consolidated total turnover of more than EUR 180 million in 2018/19 represents an increase of 16 percent compared to the previous year. A total of 6,000 EREMA plastics recycling machines are currently in operation in 108 countries around the world. The company group starts the new 2019/20 financial year with personnel changes at management level and the expansion of the company headquarters in Ansfelden/Linz.

### Management changes:

At the beginning of the 2019/20 financial year, Klaus Feichtinger will step down at his own request as CEO of EREMA Group GmbH. Together with Manfred Hackl CEO, Horst Wolfsgruber CFO is now responsible for the strategic planning and ongoing development of the entire group of companies. In order to be able to concentrate fully on this task in the EREMA Group, Manfred Hackl is handing over operational management of the subsidiary EREMA. Markus Huber-Lindinger takes over the areas of technology and production as Managing Director. Together with Michael Heitzinger, Managing Director responsible for Sales, Customer Services and Project Planning, he forms the management team duo at EREMA.



*Manfred Hackl, CEO, Horst Wolfsgruber, CFO (both EREMA Group GmbH)*



*Michael Heitzinger, Managing Director and Markus Huber-Lindinger, Managing Director (both EREMA Engineering Recycling Maschinen und Anlagen GmbH)*

### Expansion of company headquarters:

The expansion of the company headquarters in Ansfelden/Linz is also a response to increasing demand. End of March there was the ground-breaking for the construction of additional production and office space, scheduled to go into operation in spring 2020.

■ EREMA Group  
www.erima.com



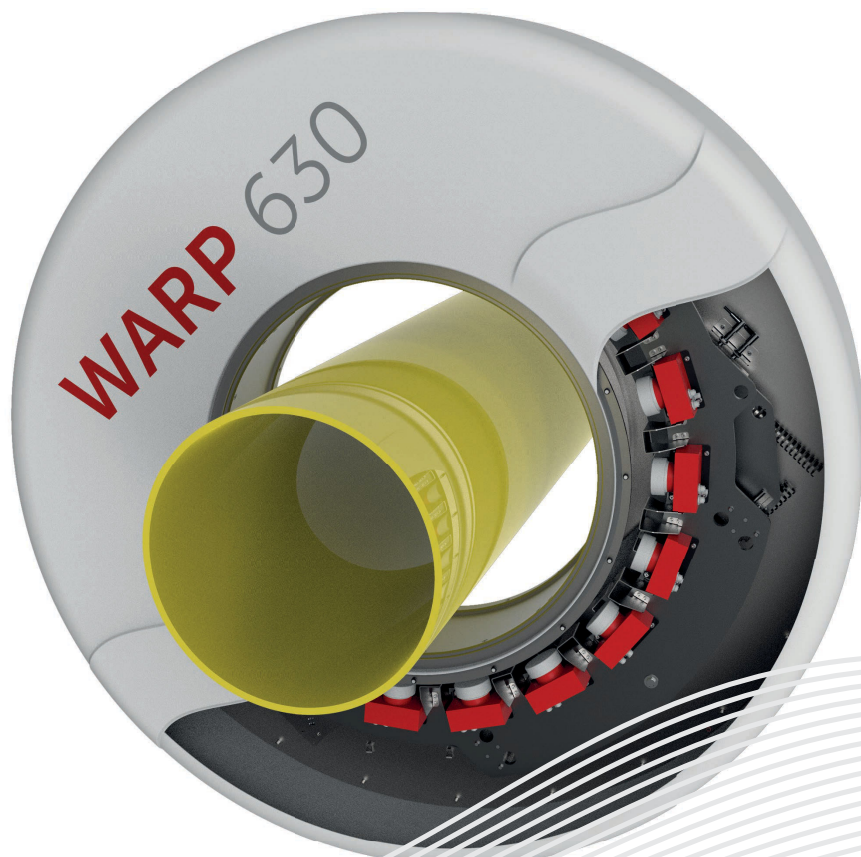

## WARP 100/630

100 % wall thickness measurement for pipes.

### Benefits:

- 100 % coverage of the pipe surface around the circumference through
  - 38 overlapping measuring spots
  - No mechanical rotation
  - Measurement of both pipe walls - sensor facing and opposite wall
- 100 % pipe surface coverage in longitudinal direction for line speeds up to 60 m/min
- No dependency on e.g. temperature variations of the pipe during production
- Comprehensive product data recording





## Management Team strengthened

■ The KraussMaffei Group has laid the foundations for future growth and is strengthening its management team with the newly created position of Chief Operating Officer (COO). Dr. Michael J. Ruf became a member of KraussMaffei's Executive Committee (EC) at the company's Munich headquarter on 1st April 2019. The Executive Committee currently consists of CEO Frank Stieler, CFO Harald Nippel and the heads of the four business segments Injection Molding Machinery (IMM), Extrusion Technology (EXT), Reaction Process Machinery (RPM) and Digital Service Solutions (DSS).

In his position as COO, Michael Ruf will lead the four business segments IMM, EXT, RPM and DSS, as well as Global Procurement, Facility Management and the Business Excellence department. His key tasks will be to implement the "Compass" strategy and the coordinated development of the operational business. He will also be responsible for the US subsidiary KraussMaffei Corporation. At the same time, Michael Ruf will lead the location development projects in Germany.



Dr. Michael J. Ruf

■ KraussMaffei Group GmbH  
[www.kraussmaffei.com](http://www.kraussmaffei.com)

## Acquisition

■ Effective February 21, 2019, KraussMaffei signed a share purchase agreement with Pultrex Ltd., based in Manningtree, Essex/UK. KraussMaffei thus strengthens

*Looking forward to the new system partnership for pultrusion, from the left: Nicolas Beyl, President of the Reaction Process Machinery segment of the KraussMaffei Group, and Colin Leek, Managing Director Pultrex (Photo: KraussMaffei)*



its system competence in the area of pultrusion. Pultrex is one of the leading providers of pultrusion, pullwinding and filament winding systems, and is itself a manufacturer of pultrusion profiles.

"With the company Pultrex, we have a valuable, experienced partner at our side, with whom we will expand our pultrusion business division for the long term", explains Nicolas Beyl, President of the Reaction Process Machinery segment at KraussMaffei Group. Pultrex has over 40 years of experience in the field of pultrusion, the continuous strand drawing of fiber-reinforced profiles and round rods. More than 600 Pultrex pultrusion systems are in use worldwide. The product portfolio includes complete pultrusion, pullwinding and filament winding systems.

KraussMaffei entered the pultrusion market in 2017, setting new standards with the iPul system. "With the expertise and experience of Pultrex, we are complementing our system competence and now offer the entire value chain from a single supplier. At the same time, we will together pursue the aim of promoting standardized pultrusion system construction, thus offering our customers solutions with optimum price-performance ratios", adds Beyl.

■ KraussMaffei Gruppe  
[www.kraussmaffei.com](http://www.kraussmaffei.com)  
 Pultrex  
<https://pultrex.com>

## Acquisition

■ As of 18 February 2019, Reifenhäuser Group acquired Plamex Maschinenbau GmbH, Kelberg/Germany. Plamex is a specialized supplier of blown film lines and extrusion components. Its core competences are blown film lines for water-cooled and biaxially oriented films for the medical and food packaging industry.

The company will continue its operations under the name Reifenhäuser Blown Film Plamex GmbH & Co. KG. Managing directors are Maximilian Herchenbach and Manfred Kurscheid. Jochen Herchenbach retires from the management, but keeps available for consultation.

The acquisition expands the Reifenhäuser Groups' product range to include an innovative technology for flexible film production. "The extremely efficient water cooling keeps the polymer in amorphous state and produces a particularly glossy and transparent film with remarkable puncture resistance and very good barrier properties. In our discussions with customers we can now provide even more differentiated advice and deliver the optimum solution for the particular application," says Bernd Reifenhäuser, CEO of the Reifenhäuser Group.

In addition to technological synergies, Plamex benefits from the strong global network of the Reifenhäuser Group and the close connection to the specialist machinery manufacturer Polyrema. "It was particularly important to us that we can continue the Plamex success story with a strong partner at our side. Reifenhäuser Polyrema is the perfect match for Plamex - both in terms of corporate structure and business focus. We are and will remain a special machine manufacturer and develop tailor-made solutions for the packaging industry," says Maximilian Herchenbach. "We are proud to be part of the Reifenhäuser Group. We will join forces and thus be able to act even more efficiently for our customers."

With the acquisition Reifenhäuser strengthens its position as technology leader in the market. "Water cooled blown film extrusion lines for medical applications, such as infusion bags, and biaxially oriented multi-layer films, have not been in the scope of the Reifenhäuser group, yet. Now we can offer water-quench, double and multi-bubble technologies, with which we can address new customer groups and thus continue our growth path", emphasizes Manfred Kurscheid, who is looking forward to working closely with the staff of Reifenhäuser Blown film Plamex GmbH & Co. KG.

## Hassle-free consistent dosing

think materials management



PLASTPOL 2019  
Please visit us:  
Hall G, Stand 19



## GRAVIPLUS

Ideal for every use.

## Market Study: Rigid Plastic Packaging – World

■ Most of the time, plastics would be useless without additives. Additives facilitate the processing of plastics, protect against heat and UV rays, and expand the range of properties by modifying material characteristics. “Only additives make it possible to permanently use plastics in ever new

applications” explains Oliver Kutsch, CEO of Ceresana. The market research company analyzed the complete world market for all major plastic additives for the second time: fillers, plasticizers, pigments, flame retardants, stabilizers, impact modifiers, slip agents, antioxidants, blowing agents, as well as other plastic additives. The Study in Brief:

Chapter 1 provides a description and analysis of the global market for plastic additives – including forecasts up to 2025: For each region of the world, demand in tonnes and revenues in US dollars and euros are given for each region of the world. Furthermore, global and regional demand per product type and application area is analyzed.

Chapter 2 examines 16 countries in more detail. Country-specific demand, demand per additive type, additive demand per plastic type as well as revenues are depicted. Furthermore, demand per individual application areas is analyzed.

Chapter 3 provides company profiles of the largest manufacturers of plastic additives – clearly arranged according to contact details, revenues, profit, product range, production sites, and profile summary. Extensive profiles of 69 manufacturers are given.

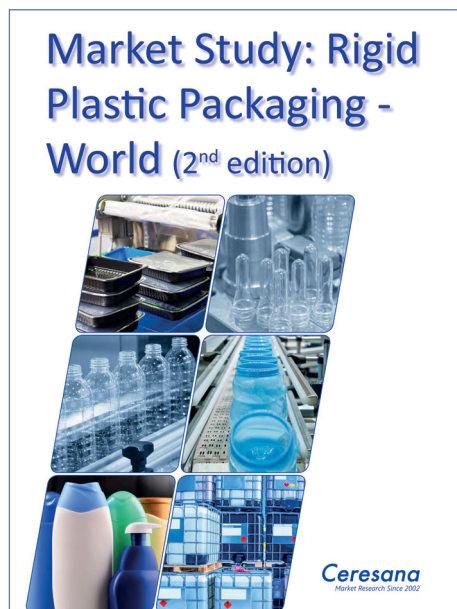

■ Ceresana  
[www.ceresana.com/en/market-studies/packaging/rigid-plastic-packaging-world/](http://www.ceresana.com/en/market-studies/packaging/rigid-plastic-packaging-world/)

## Remote Service

■ When machine problems occur, fast action is needed. This is why the Information and Diagnostic Center (IDC) is available 24 / 7 / 365 to all W&H customers worldwide. The IDC team can successfully resolve more than 80 % of all machine problems via Remote Service from three locations with its comprehensive error analysis. In April 2019, IDC celebrated its 25th anniversary.

“The 26 service technicians in our Information and Diagnostic Center are reachable day and night via our Service Hotline”, explains Christian Brönstrup, head of the IDC. A customer can speak directly to an engineer with expertise in his specific machine type via the hotline. Depending on local time, the customer reach engineers in Germany, India or the USA. Remote Service enables comprehensive troubleshooting and analysis. For almost 10 years, W&H service technicians from IDC have been able to connect to a W&H machine at the other end of the world via Internet using a remote function. With just a few clicks and operator approval, they can look into a customer’s machine, right down to the control and drive level, identify and correct issues quickly. When pur-



*Service technicians of W&H’s IDC are available 24 / 7 / 365 and resolve eighty percent of machine problems via Remote Service*

chasing a new machine, the Remote Service is free of charge during the warranty period. However, the service can also be continued with a service contract.

■ WINDMÖLLER & HÖLSCHER KG  
[www.wuh-group.com](http://www.wuh-group.com)



# Growing Recycling Market

## Plastics Recyclers Europe publishes the Strategy Paper on the state of play of the Technical Plastic Parts recycling

■ In 2020 EU will generate an additional 46% of plastic waste coming from the electrical & electronic (E&E) sector in comparison to the year 2000 [1]. Engineering plastics today are the third most widely used material, after packaging and building & construction applications and represent 16% [2] of the total EU demand. They are extensively employed in both the automotive and the E&E sector as they are lighter, more durable, provide increased safety and overall have a better environmental performance when compared to other materials. Consequently, engineering plastics are the preferred material, replacing heavier and less resistant and less sustainable constituents. Taking into consideration the growing digitalisation, their production and use will continue to grow very fast. This means that Europe will be facing a growing amount of waste from technical plastic parts [3]. Recycling rates remain low, even though facilities and technologies to treat them do exist and are operational on an industrial scale. To give an example, only 300.000 tonnes of waste from electrical and electronic equipment (WEEE) was destined for recycling at specialized European facilities in 2017, whereas the recycling capacity needed amounts to around 3 million tonnes. [4]

This shows the urgency needed to tackle the challenges that these streams present and to overhaul the obsolete waste management practices which have dominated previously. Antonino Furfari, Managing Director of PRE comments: "Today we need to reach for the untapped material which is not fully exploited yet. This will require extra effort to guarantee the conditions necessary for the recyclers of technical plastic to



boost further investment with the goal of transforming this material into a high-quality product."

The change will need to implement an improved and increased collection system as well as additional sorting infrastructure. These measures should be complemented by enabling free WEEE material circulation across the Member States. A consistent and stable legislative framework is also a prerequisite to boost investors' confidence.

- [1] Urban Mine Platform. Available online at: <http://www.urbanmineplatform.eu/composition/eee/materials>
- [2] Source: Plastics – the Facts 2018. An analysis of European plastics production, demand and waste data.
- [3] An alternative name for engineering plastics
- [4] Source : Responsible recycling of WEEE plastics containing Brominated Flame Retardants-BFR's. EERA.2018

► **Plastics Recyclers Europe (PRE)**  
[www.plasticsrecyclers.eu](http://www.plasticsrecyclers.eu)



maag pump & filtration systems

automatik scheer strand pelletizers

gala automatik underwater pelletizers

reduction pulverizing systems

### GEAR PUMPS, FILTRATION, PELLETIZING AND PULVERIZING SYSTEMS

MAAG – 4 STEPS AHEAD FOR YOUR SUCCESS

Visit us at Chinaplas:  
**Hall 5.1, Booth 551**



## Efficient Automation

■ Kiefel GmbH, based in Freilassing/Germany, focuses on efficient automation of steel rule cutting for thermoforming machines. Kiefel now offers the SpeedPacker - an optimized product packing module for the KMD Speedformer Series. It significantly increases productivity.

The thermoforming specialists have launched the SpeedPacker. This powerful module is not only suitable for the Kiefel KMD Speedformer, but is also compatible with other manufacturers' steel rule cutting machines. The SpeedPacker is a buffering and unloading station that is fully integrated into the steel rule cutting machine. Buffering is key to reducing personnel requirements and achieving tremendous cost savings. The ergonomically optimized SpeedPacker ensures safe operation. The level of the unloading belt can easily be adjusted to the suit the height of the operator. Retrofitting is also possible for machines already in use.

Kiefel machines are modular and can be expanded as required. Various stacking solutions, quality control, and packing units are available. Automation is a considerable success factor for efficient manufacturing and enhanced productivity.



*SpeedPacker - Buffer and Unloading Station for KMD Speedformer Series*

"We are always thinking about enabling our customers to optimally achieve efficient production," says Erwin Wabnig, Head of the Kiefel Packaging Division. "The forming and cutting stations of our high-speed pressure forming systems are already very efficient. Time savings are also possible in the next steps", he explains. "Reliable stacking with buffering and rapid unloading permit fast packing or filling of formed parts, further increasing productivity."

■ KIEFEL GmbH  
www.kiefel.com

## Seven-Layer Line

■ In only two years since installing a seven-layer Davis-Standard blown film line, Rani Plast of Finland is experiencing profitable outcomes for its agricultural film operation. Since the line's start-up in August of 2016, Rani Plast has expanded its family-run business by optimizing production, developing its distributor network and introducing new products. At the time of installation, this was the largest seven-layer blown film line Davis-Standard had ever built for a customer.

"Before this line, we lacked capacity and were limited to film widths of 18 meters. Being able to run expanded widths has given us access to new distributors and end customers", explained Mikael Ahlback, Group CEO of Rani Plast. "It has also given us greater flexibility to react on immediate demands from customers, shortening lead times. We're able to offer new products

such as EVOH-based barrier films that will be available the next agricultural season. This product will be sold as an underlay film as well as a conventional silage film to help customers make better silage than before."

Ahlback explained the demand for silage films, one of Rani Plast's largest markets, has risen due to the increased size of farming operations. Silage film provides an economical way to preserve and protect feed for animals. The seven-layer structure has helped Rani Plast optimize mechanical film properties for this film in a manner not previously possible. In addition to silage, Rani Plast uses the seven-layer line for making wider films used in covering peat and turf.

The line's design is a reflection of careful planning and customized engineering. A 2.3-meter, seven-layer Centrex IBC die has been an integral part of performance. This die supports enhanced film quality while providing Rani Plast with versatility for their diverse portfolio. This includes the capacity to process high-quality films with optimized coextrusion ratios for thicker skin layers and low-percentage core layers for barrier-based structures, as well as non-barrier structures using a variety of polymer blends. The die and tower are capable of producing a bubble up to 23 meters unfolded at high-output rates with a dual-lip, automatic profile control air ring. The line's seven Davis-Standard MAC extruders are fitted with DSB® feedscrews for homogeneous mixing and low-temperature melt streams, essential to film quality and the production of large width films.

■ Davis-Standard, LLC  
www.davis-standard.com

*Rani Plast installation*



# Reinforcement for 100% Food Grade PET Business

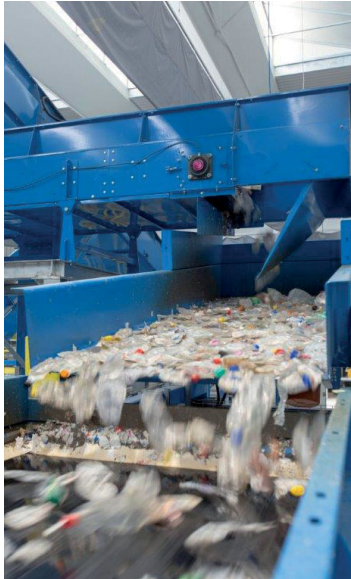

Plant view



■ “We have been working with AMUT for a number of years to develop an excellent technological and yet economical solution to meet our high standards for r-PET flakes. AMUT is a proven machinery and technology manufacturer that has demonstrated how to best meet our goals and objectives,” stated Yash Awasthi, Vice President of Indorama Ventures North American Operations regarding this project.

Awasthi continued: “The new plant will process more than 100 million pounds of plastic bottles annually into clean PET flakes to produce our FuTuRe-PET® – AMUT washing section is capable of reaching 4,000 kg/h. The processed bottles are extremely dirty being post-consumer landfill collected. These are the dirtiest bottles seen in this market and AMUT technology is able to obtain the premier value clean PET flakes from them. The cleaned PET flakes will be used to produce new resins for a variety of sustainable products which our clients now demand for their PET packaging products. Our goal is to close the loop on recycling and increase the sustainability of the PET containers”.

The new Indorama Ventures recycling facility will be located in Guadalajara, Mexico, at their Ecomex JV in close proximity to their resin production site. The new recycling plant will be operational in the fall of 2019. AMUT will also upgrade an existing unit at the ECOMEX plant as well, making the factory capable of producing over 13,000 pounds per hour of highest quality PET flakes from post-consumer PET bottles coming from landfill.

The new washing plant has been purposely developed by AMUT experts to cope with the necessity of processing very dirty PET post-consumer landfill collected bottles. These bottles are the dirtiest and require a wet-cold-cleaning technology incorporated in the de-labeller unit. The De-Labeller removes the labels, especially the full body shrink sleeves,

to improve the bottles quality to go through the following cleaning operations.

The turbo and friction washer machines, AMUT patented technology, normally perform the cleaning phase. In this case, the combined action of these two machines needed to be boosted: the friction force has been increased to remove not only fine pollutants, labels and glue but even the soil. Pre-washing and de-labelling phases are carried out in a cold water process while the turbo and friction washer have hot water flow.

The bottles are always subject to a high level of cleaning and pollutants removal inside each machine as they undergo a non-destructive high friction and proper residence time. AMUT technology optimizes the operational costs: fresh water usage is reduced to minimum because the water, that is continuously filtrated, can be re-used during the whole process and the consumption of energy and cleaning agents is really restrained.

AMUT Group  
www.amutgroup.com

**From the Simple to the Sublime**

**Series 800 crosshead for two to six layers**



The latest generation of the **Series 800 crosshead** is designed to run two to six layer extrusions for high quality, high accuracy 1/8" to 6" OD tubing for medical, automotive, appliance and industrial applications.

Ideal for fluoropolymer multi-lumen, multi-layer tubing for fuel lines or thin layer combinations of polymers and adhesives to 0.02mm or less.

Features patented **Guill Feather Touch®** concentricity adjustment to eliminate leaking.

Please visit [www.guill.com](http://www.guill.com)



10 Pike Street  
West Warwick, RI 02893  
USA  
sales@guill.com Attention: Bill Conley



## Co-Extrusion Crosshead for Irrigation Tubing

■ Guill Tool introduced Series 824, a co-extrusion crosshead designed for irrigation tubing with an emitter tool. Manufactured from stainless steel, this new crosshead features balanced flow design with spiral technology that improves flow characteristics at all extruder speeds. Dual feed ports provide concentric compound flow, while the splits flow from one extruder to feed the inside and outside layers via a manifold assembly. Series 824 is adaptable to all popular extruders on the market currently. Capacities include a max. die ID of 1.875", max. core OD of 1.250", max. tip OD of 1.500" and max. emitter tool OD of

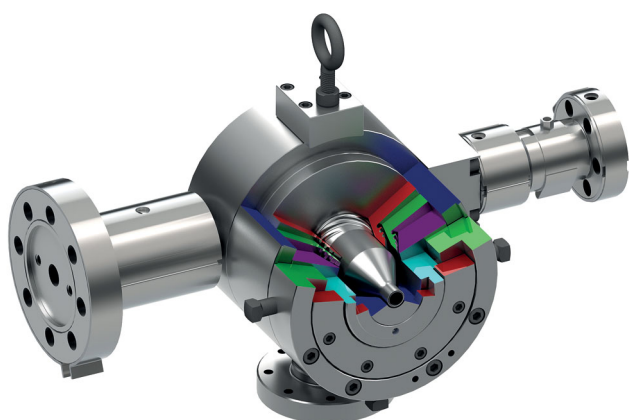

30mm (1.18"). The Series 824 design allows the emitter insertion tool to pass completely through the crosshead ID. Gum space adjustment is performed with die nut rotation, while the Guill 2-stage clamping mechanism allows easier concentricity adjustment. Quick-change tooling and a tool kit for disassembly and re-assembly are provided with the unit.

Bill Conley, sales manager for Guill, comments: "On this project, the customer challenged us with an application that required precise placement and bonding of preformed emitters within the extruded tubing without melting them in the crosshead. It was also necessary to process either a low-cost ABA layer construction or single-layer construction within the same unit."

With the Series 824, the customer realized cost reductions, better quality, less scrap and more uptime in their process. The Guill cool-tube design prevented the emitter from melting in the head and the overall unit mechanics allowed more rapid and easier changeover from a co-extrusion to a single layer.

On this project, Guill also supplied the customer the company's extrusion tool cart, which facilitates easy alignment and tool changes. The removable cart swing gates stay free from accumulated process fluids, while the adjustable height means the cart is compatible with virtually any extruder model. Thermal isolation in the design keeps heat in the head, not the cart.

■ Guill Tool & Engineering  
www.guill.com

## Battery Separator Film Production

■ The EV offensive of the European and German automobile industry will soon lead to production plants for batteries and the necessary supply chain in Europe and Germany. Battery separators are an important element for function and safety. Manufacturing demands highest quality and efficiency. Moreover possible investors count on sustainability.

The industrial solutions of Brückner Maschinenbau for the production of battery separator films are based on extensive internal R&D. For the Battery Show Europe 2019, the company presented various in-house developed stretching technologies for all three common manufacturing methods: wet, semi-dry and

dry. Brückner's portfolio comprises technical solutions for both machine components and complete production lines. Main highlights:

- Patented film transportation system with relax chain for low-shrink separator films
- Simultaneous stretching process for highest quality requirements
- Line concepts with special focus on environment friendly and sustainable processes

Sales and marketing director Karl Zimmermann says: „Because of our now more than 20 positive references from leading international battery separator producers we see best chances for us to take part from the beginning, when battery production and separator film manufacturing will be settled in Europe and Germany. Production efficiency, consistently high film quality and the further development of environmental standards are our core issues.“

*Latetst Battery Separator Film Technology*



■ Brückner Maschinenbau GmbH & Co. KG  
www.brueckner.com

## Vibration Bottom – Easy to Clean

■ For safe discharge of powdery, crystalline, fatty and granular bulk materials from hoppers. Hoppers are discharged completely without leaving residue. Funnel formation and bridging in the hopper are prevented. Can be used for virtually all bulk materials, even those that flow poorly, in the foods, plastics, chemicals and pharmaceuticals industries. Special advantages are:

- Reliable discharge and even fall of the product column (mass flow)
- Hygienic design: Smooth internal contours in the silo / hopper without any changes in diameter, smooth surfaces on the exterior, resulting in easy cleaning No inaccessible cavities and exposed screw threads
- Elastomer sleeve is easy to assemble and has an accurate fit
- The sleeve is silicone-free, conductive and is approved as food-grade, assembly using clamping segments and pressure pieces
- Screw locking by means of wedge locking washers
- Shock pressure proof to 2 bar (overpressure) and vacuum-proof
- Long elastic area, resulting in excellent disconnection between the fixed part of the hopper and the vibration bottom

How it works: The lateral, imbalance vibrator sets the vibration bottom in horizontal, circular vibration. The vibrations are trans-

*AZO vibration bottom – easy to clean*



mitted to the materials column via the simultaneously vibrating relieving cone inside the vibration bottom. This sets the bulk materials in motion and the level drops evenly without resulting in funnel flow or bridging. The bulk materials reach the outlet safely through the annular gap. Vibration intensity can be adjusted at the imbalance vibrator and depends on what materials are being discharged and the required discharge rate.

■ AZO GmbH + Co. KG  
www.azo.com

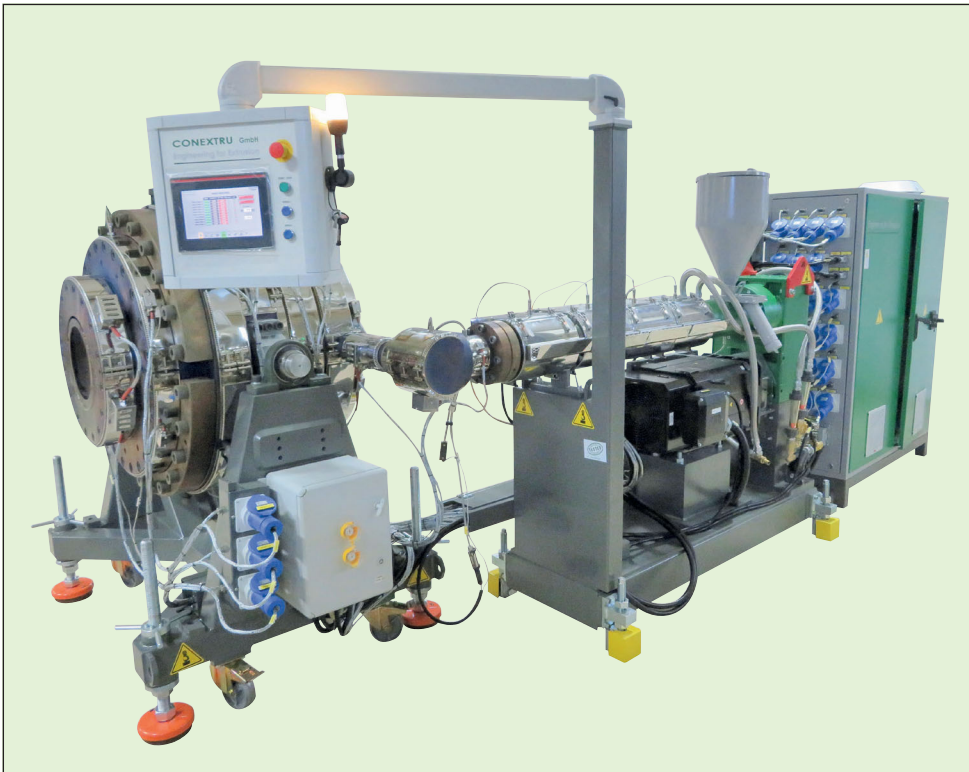

**CONEXTRU GmbH** supplies premium cross head and extrusion technology in single- or multi-layer structure for steel-pipe or plastic-pipe coating.

**CONEXTRU GmbH**

Engineering for Extrusion

office@conextru.eu  
www.conextru.eu

## New COLORex™ Color Mixer

■ Maag Americas adds The ColoRex™ Color Mixer to its line of Ambient Pulverizers. The COLORex™ is used to mix product in-line with a pulverizer to eliminate the typical cleanup time of a central mixer. It is designed for most polymers and for production rates up to 907 kg/h (2,000 lbs/hr).

The COLORex™ can also be used off-line with a loader system and multiple feeders. The COLORex™ mixer is a great alternative to traditional high-speed mixers which are time consuming and costly to clean and maintain.

The COLORex™ Color Mixer will allow the operator to color natural or virgin resins directly out of the pulverizer or from a silo. This is a high intensity mixer that will incorporate any pigment or additive homogeneously.

The COLORex™ Color Mixer is controlled by variable frequency drive for the motor speed and 480V for the mixer itself. The loss-in-weight feeder (LWF) uses 110V. International voltages available. Spare parts are available upon request.

Key benefits are: ColoRex™ Color Mixer is portable, easily moved to alternate locations; On Demand Color (portable, versatile); Eliminates Batch Mixing; Changeover time decreased (i.e. from black to yellow in under 1 hour); No confined space permits needed; Color straight from the pulverizer or a weigh station.

Specifications: Process rate up to 907 kg/h (2,000 lbs/hr), depending on material and density; Variable Frequency Drive; 3.73 kW



Maag ColoRex™ Color Mixer

(5 HP, 1750 RPM) Motor; Adjustable height for all models; CE approved; The Loss-in-Weight twin screw feeder is capable of rates as low as 0.01% and up to 4%; Color Mixer can also accept liquid color or additives; Screw design is adjustable for better dispersion; Quick clean-up; Better ergonomics than the competition.

Testing is always welcome. Demo models are available. For more information:

[www.maag.com/en/products\\_pages/pulverizing/color-mixer](http://www.maag.com/en/products_pages/pulverizing/color-mixer)

■ Maag Pump Systems AG  
[www.maag.com](http://www.maag.com)

## New Form, Cut, Stack Thermoformer for Medium-Volume Packaging Production developed

■ GN Thermoforming Equipment, a leading manufacturer of servo-driven, roll-fed thermoforming machines for the production of plastic packaging, has announced the development of a new form, cut, stack thermoformer that targets low- to medium-volume production runs for packaging for the food, medical, and industrial markets.

GN has developed the GN580 Thermoformer, which is a smaller version of its highly regarded GN800 launched at K 2016. The launch of these two new GN models, part of GN's aggressive growth strategy plans, has proven to be very successful, even beyond the company's initial expectations, according to Jerome Romkey, General Manager of GN Thermoforming Equipment. "We are known around the world as a quality- and customer-driven company and we are working diligently to meet the demands of a growing and challenging market," said Romkey.

The first new GN580 machine currently being assembled has already been sold to a European packaging manufacturer, according to GN. "The GN580 offers many of the same features as our highly successful GN800 but is well suited for smaller production runs, particularly for the medical and industrial markets," said Romkey.

GN undertook an extensive research study and determined that there was strong demand from its customer base for a machine

with similar capabilities to the GN800 but within a mid-size production capability range. GN said the new machine features advanced technology and is flexible and user friendly.

The GN580 adapts many of the same unique features of the GN800 and handles all thermoformable grades of PET, OPS, HIPS, PLA, PP, and PVC. The GN800, which was shown at NPE 2018 in Orlando, offers many standard features including in-mold-cut capability, auto-grease, heavy-duty bearings in the toggle system, and high-efficiency SOLAR heaters. Among the top priorities of GN's customer-focused approach are improving productivity and ensuring that customers produce the most finished parts per pound of sheet. Over the years, GN has perfected the common-edge-cut tooling technology for their contact- and radiant-heat series of thermoformers. Common-edge tooling offers the ability to form a series of square or rectangular trays in a row or multiple rows while reducing web between the edges of the products.

Initial plans call for the GN580 thermoformer to be shown this year at the K 2019 exhibition October 16-23 in Dusseldorf, Germany.

■ GN Thermoforming Equipment  
[www.gncanada.com](http://www.gncanada.com)



## Breakthrough Hybrid Evaporative Cooling System launched

■ Thermal Care, a leading manufacturer of process cooling equipment, has announced the commercial launch of a breakthrough hybrid film evaporator chiller that reduces energy use by 34% and uses less refrigerant than competitive flooded chillers.

The company's new Accuchiller TCF model chiller uses a Hybrid Film Evaporator which provides the energy efficiency of wet (flooded) systems in a compact footprint using less refrigerant, according to Bob Smith, Thermal Care's Director of Product Management. The Accuchiller TCF is Thermal Care's first Hybrid Film Evaporator system and builds on the success of the company's industry-leading variable-speed, centrifugal compressor systems. Thermal Care also combines the energy savings of the new TCF chiller with their other energy savings technologies like adiabatic fluid coolers and free cooling system designs.

The new Accuchiller TCF was developed in response to market demand for improved energy efficiency and reduced refrigerant charges. Thermal Care is one of the first industrial chiller manufacturers to commercialize this breakthrough technology for process cooling market segments including plastics processing, food processing, metalworking, and other key industries.

Unlike current flooded evaporative systems which immerse copper water tubes in liquid refrigerant, hybrid film evaporation systems use a thin film of refrigerant to achieve more energy efficiency with a reduced amount of refrigerant.

The hybrid technology boasts a compact modular design, providing a 25% smaller footprint which maximizes floor space and helps to reduce production costs for manufacturers.



Accuchiller TCF

The Accuchiller TCF also features Thermal Care's unique advanced PLC control system which controls, monitors, and maintains stable and reliable operation of the pumping system. A durable color touchscreen displays a variety of operational screens for an uncomplicated view of the system, including time stamped faults or alarms and compressor and pump hours. The Accuchiller TCF is also equipped with an Ethernet port and is fully compatible with the company's CONNEX4.0 plant-wide equipment remote control and monitoring system.

■ Thermal Care  
www.thermalcare.com

## Precise Control of Temperature Processes

■ TWith mapp Temperature, B&R offers temperature control that combines maximum usability and powerful control algorithms. Integrated simulation capabilities allow virtual commissioning in minutes. mapp Temperature also provides heating current monitoring.

With mapp Temperature, it is possible to define zones and groups for temperature control. A zone is a unit consisting of an actuator, a temperature process and a sensor for measuring the temperature. Multiple zones can be combined into a physical group and controlled and optimized together. This gives the

*B&R's temperature control component covers every requirement with maximum flexibility and scalability*

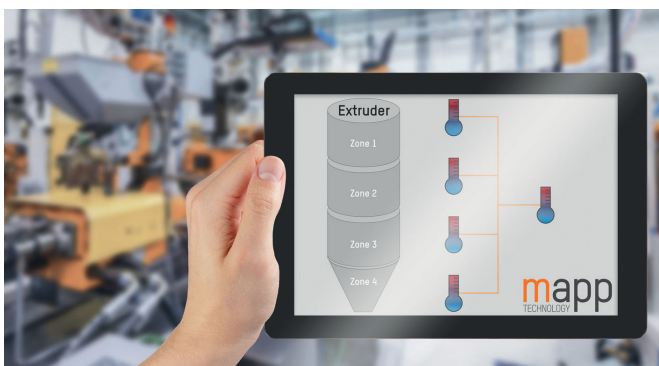

user maximum flexibility and scalability to meet any temperature control requirement.

If applications cover a wide temperature range, simple tuning is often not sufficient to optimally adjust the parameters. mapp Temperature therefore includes a multi-stage autotuning process. The user can define several operating points and optimize them individually. The integrated simulation capability enables simple virtual commissioning without any hardware. This option makes it possible to test the application's logic, error handling and HMI system in advance to significantly accelerate on-site commissioning.

B&R's temperature control system also offers heating current monitoring to enable early detection of faults through predictive maintenance. By monitoring the current of the heating elements, it is possible to react to a fault at an early stage without stopping the entire process. This ensures a high level of operational reliability and helps prevent extended downtime.

■ B&R Industrial Automation  
www.br-automation.com

# Interplastica 2019 – Russia's Economy is Picking Up

The Russian market seems to be finally moving out of the trough at least as regards the plastics, rubber and packaging sectors and related process industries. Impressive proof of this has been provided by the two trade fairs interplastica, 22nd International Trade Fair for Plastics and Rubber, and upakovka – Processing and Packaging, which drew to a successful close after four trade fair days on 1 February 2019. To the tune of 25,000 visitors came to Moscow to seek information on the extensive ranges displayed by 950 exhibitors from 32 countries.

After a period of stagnation in 2016 and a -2.8 % recession in 2015, Russia saw a new growth phase start in 2017 with 1.5 % GNP growth. Four years after the sanctions were imposed and the oil price dropped the Russian economy has adapted to the new circumstances and managed to grow again.

There is a great deal of renewed interest in modern machinery, production plants and high-tech materials. This also especially applies to demand for packaging technologies and plastic processing equipment. To the delight of the exhibiting companies, activities at interplastica und upakovka were therefore not only confined to an exchange of information. Many trade visitors also came with concrete intentions to buy and took their purchasing decisions right on site. This underpins the substantial investment needs that continue to exist in Russia and its neighbouring states.

The presence of numerous foreign exhibitors evidences the sustained strong

interest taken in the Russian market. "Following some difficult years things are picking up again. Those showing stamina will now be rewarded," reflects Werner Matthias Dornscheidt, CEO and President of Messe Düsseldorf, drawing a positive conclusion. Very satisfied with the results of the two trade fairs, he goes on to say: "The mood in the halls was excellent, exhibitors reported extremely interested business people who were also prepared to place orders. They capitalised on the unique opportunity here to see the latest developments in world markets and negotiate with suppliers on site."

In 2017 (for want of more recent figures) plastics and rubber machines worth EUR 457 million were exported to Russia from all over the world; this means 40.4% more than in 2016 (325.5 million).

From January to September 2018 plastics and rubber machinery exports from Germany totalled EUR 90.8 million – a 3.3% plus against the same period of the previous year.

Commenting on this Thorsten Kühmann, General Manager at the Fachverband Kunststoff- und Gummimaschinen (the Plastics and Rubber Machinery Association within the VDMA), said: "Following a marked rise in German deliveries to Russia in 2017, these levels were maintained and had even raised slightly by November 2018. As before there are clear impulses for the packaging sector as a direct upshot of the Russian food sanctions. As a result, packaging must increasingly be produced in Russia to preserve regional foodstuffs. Add to this the positive effect companies with local branches can feel as their stamina is increasingly rewarded. It is true that the Russian market has not been able to follow on from the successful years around 2013 yet but it offers compensation in volatile times."

Austria and China were represented with strong joint pavilions at interplas-



tica 2019 while Germany promoted the quality seal "Made in Germany" with a large, official German participation. Furthermore, Italy attended with its usual strong participation. 65 Italian exhibitors at individual stands and at the big country pavilion provided a comprehensive overview. Fabrizio Vanzan, Exhibition Manager at AMAPLAST, summed it up as follows: "interplastica 2019 proved very positive for us and even exceeded our expectations against the backdrop of the known, difficult economic situation. Our Italian exhibitors welcomed many existing customers but also new customers from Russia and its neighbouring countries to their stands. We expect very good follow-up business."

The ranges displayed by interplastica exhibitors were complemented by a programme of high-calibre technical events. At the Polymer Plaza expert lectures and panel discussions addressing such current issues as "Plastics and the Circular Economy – Recycling Trends and Rising Environmental Conscience", "Innovative Trends in the Modern Polymer Industry", or "Biopolymers and Recycling" made for packed rows in the audience.

The next interplastica in Moscow will be held from 28 to 31 January 2020, once again concurrently with upakovka. For further information:

Messe Düsseldorf GmbH  
www.interplastica.de





## We are pleased with the trend towards environmentally friendly solutions

### Interview with Marek Nikiforov, Global Key Account Manager at GN Thermoforming Equipment



GN Thermoforming Equipment exhibits its technologies at Interplastica every year. Marek Nikiforov, Global Key Account Manager, spoke about the company's prospects on the thermoforming equipment market.

We have been producing thermoforming machines for 40 years. GN Thermoforming Equipment is headquartered in Canada. We also have GN EUROPE Thermoforming technical center in the Czech Republic. There we provide training and materials tests. For instance, Milliken, a material supplier many of our customers order from, often takes a chance of this opportunity.

In Russia, we have been marketing our products since 1995 and at the moment we have a strong position in the thermoforming equipment marketplace. Our application focus is thermoforming trays, containers and offsets. In Russia Komus-Upakovka company is considered to be a leader here. It has 50 GN machines. This is where our promotion to the Russian market began and then proceeded to other regions. Now most transparent packaging manufacturers have machines made by GN.

As for our worldwide activities, our equipment is supplied to 75 countries, including the USA, Canada, Europe, Colombia, Chile, Argentina, Mexico, New Zealand, China, the

Middle East. The USA is a very important market for us. Latin America is an interesting market with its own peculiarities. The Mexican market seems very similar to the Russian one, as transparent packaging is also widespread there.

Speaking about global market trends, we are pleased with the intent to use environmentally friendly solutions. Most of the world-known producers, such as Danone, claim that by 2025 they will stick to manufacturing packaging made of recyclable polymers only. Thereby, some companies turn to collecting not only PET bottles for recycling needs but packaging waste as well. Therefore, we strive to sell more equipment for PET packaging manufacture.

At Interplastica we presented our GN 800 machine. It is reliable and is being sold quite successfully. Now it is the major technology for transparent packaging production marketed by GN.

GN Thermoforming Equipment has won the Russian market long ago. So 70-80% of our activities at the trade show are meetings with regular customers and only 20% are new contacts. Naturally, we intend to come to Interplastica next year as well.

GN Thermoforming Equipment  
www.gnplastics.com

## Russia is an interesting yet special market

### Interview with Mr. Ferdinando Caridi, Sales Manager at Tecnova S.r.l.

### Mr. Ferdinando Caridi, Sales Manager at Tecnova S.r.l., speaks about peculiarities of the Russian market



Tecnova has been participating in Interplastica for many years. It is an interesting market yet a special one. It has some peculiarities because of mentality of Russian customers. It is very important to have local support or a sales office with a Russian team to continue the relationship between the company and the customer.

Besides, it is not an easy period for business here due to political situation and economical bans. We also see China and Turkey signing partnership agreement with Russia. One cannot call it encouraging news for us. Besides, a different exchange rate compared to that one 3-4 years ago made it impossible for many Russian companies to afford buying European machinery. One should have very

unique technology to keep competitive here. Still we think Russia is a perspective market for us.

Our core business is extruders for plastics recycling. In Russia recycling business is still developing. So we are here to expand our business for post consumer recycling. We witness consumers in Russia start sorting waste and get used to the idea of recycling. This is the first step. We hope that in future the demand for recycling machines will be growing here.

Tecnova S.r.l.  
www.tecnovarecycling.it

## It is Time to Develop Russian Market

Interview with Andreas Backhaus, Sales Manager at MIXACO Maschinenbau.

Sales Manager at MIXACO Maschinenbau,

Andreas Backhaus shared its view of the Russian market specifics



*Are you exhibiting at Interplastica for the first time?*

It is our first visit to Interplastica after 3 years pause. Now we'd like to push forward the business further more in masterbatch and additives applications, and compounding application. We see a lot of possibilities. It is a strong and price-sensitive market. We are high-quality machinery producer. Our machines with innovated mixing technology give our customer higher benefits. For many customers it's difficult to buy high-quality machines with higher prices. They think they cannot afford buying high-quality equipment. And this is where our work begins. It is important to show and explain the customer the advantages and

benefits of using state-of-the-art mixing technology.

Our company was founded in 1965 and since then we have been providing state-of-the-art solutions for the mixing machinery market. We are market and technology leader trying to design new mixing technologies for our customers to optimize their production and to create a higher benefit. We think it is time to develop Russian plastic market. It is a step-by-step story, a long-term work. We have already done this successfully in the field of powder coating applications. Our goal now is to develop long-term partnership with the local producers who understand the benefit of using high-quality machinery with longer life-time.

*What regions are your key markets?*

Europe, of course, North America, Asia and Russia.

*What do you think about Chinese competition?*

Luckily Chinese companies do not focus on mixing equipment as mixing technology is not their strong point. Our advantage is also that all our machines are patented. Since high-quality industrial machinery is always a question of investment, in Russia some producers start business with Chinese equipment. They start earning money and then turn to caring about saving money by using high-efficient technologies. So they come to buying European machines and replacing the old equipment with the new one of high-quality. This is the way the customer goes sometimes in Russia.

*What difficulties do you face on the Russian market?*

It is mostly about showing the benefits of our solutions to the customer. The first question is always about the price. But the client should realize what performance he gets for that price. It is our competence to demonstrate the advantages of our solutions.



## We are a company that is a step ahead

Interview with Mario Petrozzi, Area Sales Manager at Friul Filiere S.P.A.

Mario Petrozzi, Area Sales Manager at Friul Filiere S.P.A., shared his impressions of Interplastica

*Every year Friul Filiere participates in Interplastica. Why is Russian market so important for you?*

We believe Russian market has great potential. We are sure that Russian market can give more. At Interplastica 2019 there are more interesting contacts compared to previous years. It is not only about the number of contacts. Now the visitors are not just curious. They come straight to the point, ask certain questions and are ready to sit down, discuss and negotiate.

*Do you face any challenges in Russia?*

Some difficulties may be connected with situation in economics here. Sometimes companies delay decisions on purchase as they have doubts upon investment. We try to help our customers to deal with it by customized solutions.



I should say, we are a company that is a step ahead of the competitors as we introduce new technologies to the market. It takes us apart from major competition. It takes much energy, investment, resource. But it's worth it in the end.

*What is your key exhibit here today?*

At Interplastica we present a wide range of our innovative solutions. One of them is a new extrusion line Futura40. It is a completely new extrusion line under many technical aspects which have been captured by us from our customers. When you produce 24 hours a day you better understand what you need and how the extrusion line should be to help you in your job. We are grateful to our customers for providing us unique feedback enabling us to make improvements to the machines. So we are proud about that approach.

■ Friul Filiere S.P.A.  
www.friulfiliere.it

## Russian Customers understand Technical Thinking of our Company

Interview with Abderahmane Ouhbi, Export Manager at Ihne & Tesch GmbH

Abderahmane Ouhbi, Export Manager at Ihne & Tesch GmbH, commented on the company's prospects in Russia.

Ihne & Tesch exhibits regularly at Interplastica trade show. We pay much attention to the Russian market as we see high demand for our products. Russian plastics processing market is huge. We believe we can win many new customers here.

I have discovered some special features about Russian mentality. Russian people are very well-educated and skilled. They are interested in technical issues. They understand the technical thinking of our company and they see the difference in product's quality even if they have to make a decision due to the price. They realize their choice. Sometimes Russian businessmen happen to prefer cheaper products. But cheap things can come very expensive. It is not about the price of spare parts in case of machine failure, but about the cost of downtime. And we see now it has become more and more popular in Russia to buy high-quality product. We are here to meet existing customers and meeting new clients and also making our brand more popular in Russia.

Our brand is well known in European countries. Since 1932 our competence has been high-grade electrical heating products for all industry sectors, where heat is part of the production. There are numerous applications, where our electrical heating elements are in operation. Our extensive product range of temperature sensors, controllers as well as ovens make our program of delivery complete.

Ihne & Tesch is a German-based company with 3 facilities in Germany, 1 in Austria, 1 in France and also a sales office in the UK. As a global wide company we have distributors and representatives all over the world, including North America, Asia and Russia.

■ Ihne & Tesch GmbH  
www.elektrowaermetechnik.de



# Being Self-Employed in the Extrusion Industry for 10 Years – A Conclusion

*Josef Dobrowsky did not know where his journey would lead him when he first started his own engineering office. Nowadays anything else is unimaginable for him. He is planning, developing and optimizing extrusion systems for OEMs and processors. His key competences are extrusion systems and production techniques for polyolefin pipes. Not just simple solutions but specialties. "I dare to solve complex problems that require innovative ways", explains founder and holder of the Austrian Conextru GmbH in the interview with EXTRUSION*



*Mister Dobrowsky, what are the changes the pipe extrusion industry went through in the last 10 years?*

**Josef Dobrowsky:** In general one can say that the requirements for pipes are constantly rising. Although standard pipes still find use as pressure or sewage pipes, the demand for special solutions gets more and more noticeable.

*Could you mention some examples?*

**Dobrowsky:** Special solutions come in various appearances. This can be standard pipes coated by one or multiple layers of special mate-

rials or multi-layer solutions. Pipes for potable water with a protective layer to prevent the intrusion of outside carbon hydride are just one example. Another example is piping for geothermic use which has to be produced by rotating tools.

*Which kind of technique is required to produce pipes like that?*

**Dobrowsky:** The extruder is usually a standard extruder; the technical know-how shows in the pipe head. Depending on the utilization a multi-layer pipe head or a coating pipe head with a special radial

or spiral distributor is needed. Right now I am concentrating on the topic of 'rotating tools' used for processes like the production of pipes with spiral ribbing. I also lectured on this topic at the AMI-Conference in Düsseldorf in April.

*Do you manufacture the extruders and dies yourself?*

**Dobrowsky:** I don't. In the past 10 years I have established a close network of enterprises I cooperate with. I am the expert that visits the customer, examines the problem, counsels, undertakes the entire



planning process, prepares the specification, monitors the construction and attends assembly and launch. Fabrication and assembly is done by my Turkish partner enterprise. There we also test the equipment before shipment. The main components are obtained from Europe to ensure quality. Therefore is my catchphrase, "Developed and engineered in Austria, manufactured and assembled in Turkey".

*That sounds like you have direct contact to the processor. Is that your main customer base?*

**Dobrowsky:** Yes, I transact approximately 80 % of my projects directly with the pipe producer, who approaches me with his individual task. Often being small and medium-sized companies, who approach me with various questionings. I, for example, designed a four-layer cross head to apply a spiral color stripe inside a three-layer pipe, found a space-saving solution to convert a single to a three layer pipe extrusion line and engineered a moveable cross head that is able to be used instead of three single heads with an extremely high range of pipe diameters.

*But you also work for the big players?*

**Dobrowsky:** Yes, of course. Big pipe producers like Simona und Wavin are part of my client base. I signed non-disclosure-agreements with all of my clients.

The diversity of projects and clients is what makes my work exciting for me. All the projects I complete make me keep refining my technical know-how, and stay up to date with technology, which is very important for perfect counseling.

*In the beginning years of your engineering office the majority of your projects were done for mechanical engineering companies, weren't they?*

**Dobrowsky:** That is true. In the first years my work consisted up to 80 % of projects with and for pipe extrusion manufacturing companies. Today they only make up 20%. Nonetheless they still are interesting projects I enjoy. In the last years I've worked with major pipe extruder manufacturers like Windsor, Cincinnati Milacron USA, Liansu, Tecnomatic, Mikrosan or Rollepaal reworking upgrading extruder and

pipe head series. In addition to that I advised the companies concerning optimal installation configurations.

*What is the client's main advantage in commissioning you?*

**Dobrowsky:** The main advantage is the holistic consultation. I take care of every detail like space requirement to shipment and I'm highly focused on the client's individual question. A workwise like this is only possible as a sole entrepreneur. Another advantage is my cost-effective business structure. The clients receive special solution at an attractive price.

*Industry 4.0 is one of the omnipresent topics of the plastic sector. Do you notice that?*

**Dobrowsky:** Yes, I do notice it. Although I honestly have to say that industry 4.0 in the pipe sector is still a topic of the future. Nevertheless, even now, all of the extruders of the Conextru series are industry 4.0-ready. I am working with ABB control, which is network compatible. The special feature of our control systems is the ease of operation. The operator needs no training.

*What are your future career plans?*

**Dobrowsky:** I would like to work in the plastic sector for another ten years. The challenges of difficult questionings and finding innovative ways are very enjoyable for me. With my network of European component suppliers it is possible to realize almost every mechanical engineered solution.

*We wish you all the best for your way!*

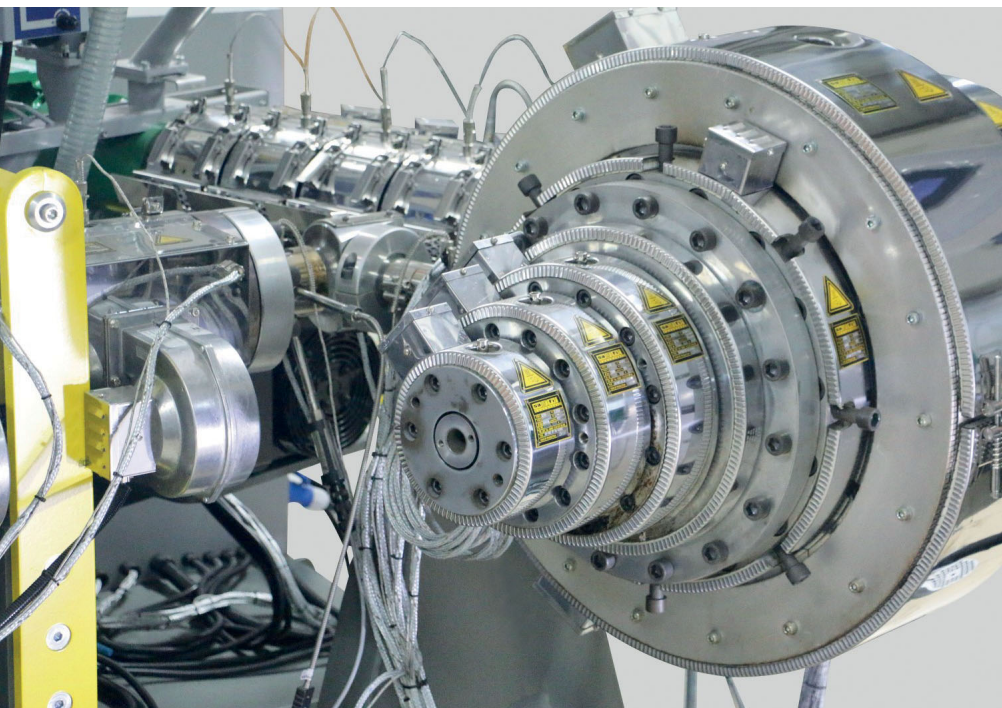



# The 13th Asiamold witnessed an Outstanding Attendance Increase

*An outstanding 37% attendance increase, a comprehensive range of high-profile seminars and most encouraging feedback from both exhibitors and buyers summed up the success of the 13th edition of Asiamold 2019 – Guangzhou International Mould & Die Exhibition – held in March 10-12 at the China Import and Export Fair Complex in Guangzhou, China, concurrently with SPS – Industrial Automation Fair Guangzhou (SIAF)*

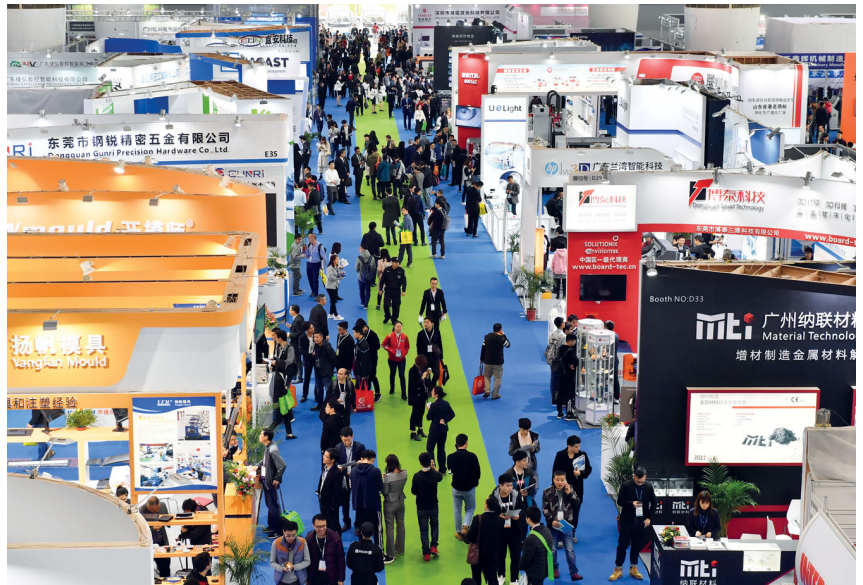

Keeping pace with the latest development trends of the industry Asiamold proves to be one of the most important platforms for moulding technologies, additive manufacturing and 3D printing in the South China region.

Together with SIAF it welcomed 98,776 visitors from 45 countries in 5 halls with the total exhibition area of 62,000 sqm. 988 exhibitors took an opportunity to showcase their innovative solutions for industry experts.

At the concurrent events, such as the Agora and Seminar and the China 3D Printing Industry Technology Application Summit, industry professionals ranging from manufacturers and product suppliers to distributors and end-users shared the state-of-the-art technologies, market tendencies and future application trends.

The organizers of Asiamold, Guangzhou Guangya Messe Frankfurt Co Ltd, are looking forward to setting new records and showcasing new technologies and innovative solutions at the next edition of the trade fair to be held from 26 – 28 February 2020.

Asiamold, formnext and Intermold Japan are a series of international events of Messe Frankfurt Group for mould and die, additive manufacturing and 3D printing industries.



Guangzhou Guangya Messe Frankfurt Co Ltd  
<https://asiamold-china.cn>  
[messefrankfurt.com/guangzhou/en.html](https://messefrankfurt.com/guangzhou/en.html)

# Connecting Bright Minds

## Interview with President of Mesago Messe Frankfurt GmbH Petra Haarburger and Vice President Sascha F. Wenzler

*Please tell us in what way Asiamold 2019 is different from its previous issues*

### Sascha F. Wenzler

Originally, when Asiamold started about 13 years ago, it was just an ordinary mold and die show. But now we witness the share of additive manufacturing growing here. It's naturally since Asiamold is also a Formnext brand where AM is its core part.

The additive manufacturing technologies have become very strong during the last 5-7 years. When we launched Formnext 2015 in Germany, it was also developing in Europe and in the USA as well. But China has been developing very fast since then. A lot of Chinese companies have come to the innovative technologies market recently. That's what we're facing at Asiamold.

### Petra Haarburger

Moreover, at formnext the international attendance from China is number 1. The second one is the US. It also reflects how fast the market is growing here. It should be mentioned, that Formnext covers all the process chain from design to the finished product. The material side is getting more and more important involving not only plastics but ceramics, metal and combined materials as well. All these encourage new technologies development. That's what we can see here also happening in China.

*Please give us more information about AM most perspective applications.*

### Sascha F. Wenzler

As for applications, automotive, aerospace and medical are main drivers, of course, but the technology tends to cover

more and more industries. Almost every week new applications are coming to use additive manufacturing and 3D printing. It's very dynamic and Formnext trade fairs are perfect to reflect the process.

One more important issue is that one might call AM a very digital business. Industry 4.0 is a most vital topic nowadays. With additive manufacturing you have an idea and data, you program it and design it in 3D. And you just print it on a machine. Then you need a lot of post processing machinery but you should do it in a digital workflow. That's where an innovative approach also lies.

### Petra Haarburger

In this connection, we should mention spare parts production as a great market for AM. Obtaining customized spare parts has become very easy thanks to additive manufacturing and 3D printing.

### Sascha F. Wenzler

Still it is new to apply it in an industrial way. Even in China the most part of 3D printing is used just for prototyping. In Germany and the USA prototyping with 3D machines has become a standard already. And now more and more companies are developing applications in regular manufacturing. It's not mass production yet small-series of customized products, for example.

*Please tell some words about challenges you are facing, especially while working at the local markets.*

### Petra Haarburger

On the one hand, our key issue is to identify the visitor target groups for exhibitors to meet their potential customers in Ger-



many, China or Russia. It's challenging every year in every country. Another point is education issue. We work closely together with the Fraunhofer Institutes and VDMA to teach people how to get better result of the product. Buying an expensive 3D printer does not solve the problems at the production process level. That's why there are a lot of seminars at Formnext, Asiamold and Rosmould. Our corporate slogan is Connecting bright minds. The creative platform where the right people meet is our core competence.

### Sascha F. Wenzler

Every local market is very specific. So we are very happy to have a network of trade fairs with local colleagues in the Messe Frankfurt global network who can take care of the special demands of Chinese and Russian markets and adapt the trade show to the local needs.

### Petra Haarburger

Besides, you need some patience. When we acquired Rosmould 3 years ago, one could think it's just Formnext evolving in Russia. But it does not work like that. One cannot bring the status quo in Germany one to one to Russia or China. It's not a miracle. It's a step-by-step process. So it is about managing the expectations. And, of course, it is also about educating our colleagues, on the one hand, and learning something new for ourselves, on the other hand. All of us are a part of the Formnext community and we keep on progressing together.

Mesago Messe Frankfurt GmbH  
<https://corporate.mesago.com/events/en.html>

*SIKORA measuring device and processor system combined ensure maximum performance during hose and tube extrusion*

*With the X-RAY measuring system X-RAY 6000 PRO from SIKORA quality control of hoses and tubes is done fast and precisely, directly in the extrusion line. Within milliseconds, an X-ray image of the product is generated showing all measuring values, such as diameter, ovality, wall thickness and eccentricity. The measuring values are visualized on the monitor of the processor system ECOCONTROL 6000. SIKORA continuously optimizes the performance of the measurement solutions, enabling the operator to use its full potential for process optimization*

*X-RAY 6000 PRO with standard display of eight measured values on the ECOCONTROL 6000 processor system*



## Using Measuring Technique to its Full Potential

Since the early 1990s, SIKORA has been offering X-ray technologies in combination with processor systems for the quality control of cables. In 2004, these technologies were transferred to the hose and tube area. While processor systems of the first generation were limited to visualize four measuring values, their mean value as well as the smallest wall thickness, today, the operator receives a far more complex display due to a higher processor performance. The X-RAY 6000 PRO for the measurement of multi-layered products is combined with the display and control system ECOCONTROL 6000, a powerful processor system

with a vertically mounted 22" TFT monitor, which shows the measuring values numerically as well as graphically as trend and statistical data. The wall thickness is displayed at eight measuring values as standard. Additionally, an intelligent physical evaluation model determines the minimum wall thickness, meaning the available value that optimally supports the operator to control the process. Moreover, the physical model enables the visualization of the wall thickness at any position over the total circumference of the hose or tube. For example, as an alternative to the standard display of 8 measuring values, a visualization of 12 or more measuring values is possible. The operator selects how many points and at which position the values are being displayed. Furthermore, the processor system is used for an automatic control of the line speed, respectively extruder rpm. Hence, it guarantees to comply with given specifications as well as the highest performance for a maximum of process optimization and productivity. The X-RAY 6000 is available as an alternative to the X-RAY 6000 PRO. The measuring system focuses on single layer products. The product data is displayed on an integrated 7" monitor at four measuring points. In combination with an ECOCONTROL 6000, 1000 or 600 processor system, a line control regarding line speed or extruder rpm can also be realized.



*Display of twelve measured values on the ECOCONTROL 6000*

SIKORA AG  
Bruchweide 2, 28307 Bremen, Germany  
[www.sikora.net](http://www.sikora.net)



# Larger Capacities in Europe and Asia

*The Italian SIMPLAS offers larger capacities in the production and service of dies for film and sheet extrusion. The tool manufacturing facilities of the Austrian partner Greiner Extrusion in Austria, the Czech Republic and China are used as platforms*



*Simplas is a leading supplier of wide slot dies, feed blocks and accessories for plastic film and sheet extrusion as well as for coating and hot melt coating applications (Pictures: © Greiner Extrusion)*

Simplas and Greiner Extrusion have been cooperating since mid-2018 in the field of dies for film and sheet extrusion. Based in Northern Italy, Simplas is one of the leading suppliers of wide slot dies, feed blocks and accessories for plastic film and sheet

extrusion as well as for coating and hot melt coating applications. The core competencies lie in development, design and process engineering. Greiner Extrusion, an Austrian company, is co-owner of Simplas and manufactures extrusion tooling and

components for plastics machinery at eight locations worldwide.

By bundling the strengths of both companies, networking the locations in Italy, Austria, the Czech Republic and China as well as extensive investments in modern processing machines, dies with a width of up to 8 m can be manufactured. The top priorities are attractive delivery times as well as professional and rapid on-site support. Service, repairs and refurbishment for dies of all manufacturers are offered.



► Simplas S.p.A.  
Via Cavour, 88,  
21051 Arcisate (VA), Italy  
[www.simplas.it/en](http://www.simplas.it/en)

Greiner Extrusion Group GmbH  
Friedrich-Schiedel-Str. 1,  
4542 Nussbach, Austria  
[www.greinerextrusion.com](http://www.greinerextrusion.com)

*The production of offshore Flexibles involves complex process's requiring varying individual performances for quality control. Any deviations from the required standards can risk horrific consequences if failure occurs depending the application scenarios. In order that the risks for future product failure are eliminated during the manufacturing processes, such as wire drawing, profile rolling / extruding, stranding and sheathing, ZUMBACH provides reliable solutions for the measurement of all critical parameters*

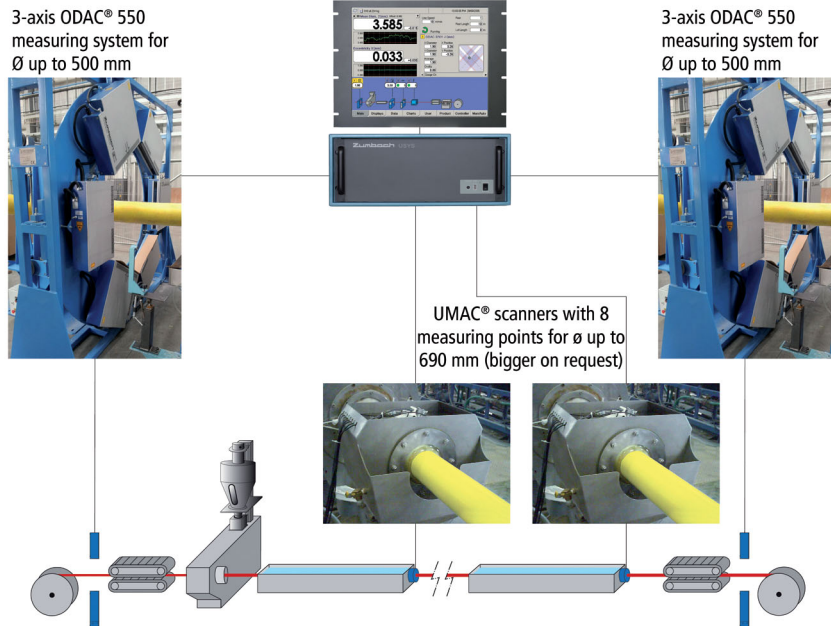

*Zumbach has measurement solutions for nearly all wires, cables, tubes and profiles. Any Offshore flexible can be measured with gauges from ZUMBACH*

## All Components in View – Measure Any Offshore Flexible



*3-axis ODAC 550 system, measuring an Offshore cable of 500 mm OD*

### Step by step all values under control

From the first seconds of extrusion, ultrasonic measurement systems (UMAC®) with up to eight real measurement points, allow the eccentricity, independently of the material temperature to be measured. Once the eccentricity of the cable is optimized, it comes down to the next stage of maintaining the required average wall thickness and then further to derive the minimum wall thickness limitation. These measurements are typically performed before and after the extruder by ODAC® and UMAC®. An additional measurement of the outside diameter at the end of the line allows the integration of the measured cold diameter value. This allows the determination of the shrinkage, which can thus be fed back within the process to realize optimum configuration.

Similar approaches generate quality improvements in pipe extrusion. At the beginning of the process, the eccentricity of the pipe must be brought under control, then the wall thickness and finally outer diameter as quickly as possible. The optimization of the wall thickness and the monitoring of the outside diameter is also ensured by the combined and cost-effective ultrasonic and laser measurement technology from Zumbach.

Accurate process monitoring and quality control during cable and pipe extrusion

In the extrusion of cables or pipe jackets, UMAC® ultrasonic measurement ensures early notification of product centralization and achieved Wall thickness. UMAC® measures and controls parameters such as eccentricity and wall thickness for up to 5 layers of materials at a maximum of 8 individual measuring points around the circumference. Additional installed ODAC® or MSD® diameter measuring heads benefit by checking the diameter and ovality. Using these technologies, allows the manufacturer to closely monitor the extrusion processes and thus continuously maintain the quality requirements.

**Dual Loop Strategy maximizes quality on extrusion lines**

Control solutions such as Zumbach’s dual-loop method, as example, takes

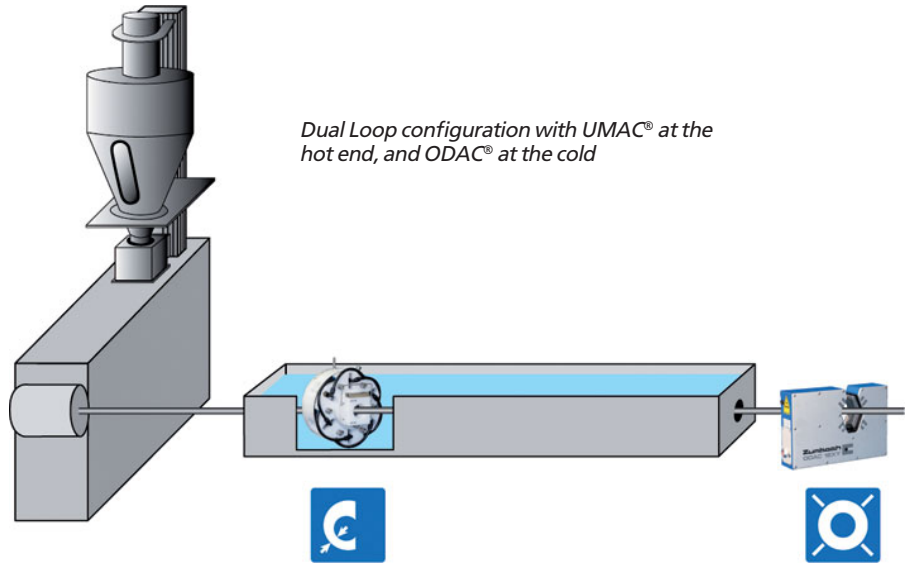

into account the product properties in both the hot and cold conditions. The resultant reported data is determined from a combination of the diameter measurement using ODAC laser measuring heads and UMAC ultrasonic eccentricity and wall thickness scanners. Wherever several ZUMBACH systems are used in combination, remarkable successes can be achieved in DLP measurement and control.

Considerable thought should always be given to investing in several high precision and reliable control technologies within the extrusion line. After all, global material costs are rising just as fast as quality requirements. Whether it is quality improvement for

very precise cables or further material savings for commodity tubing – with the ZUMBACH hot end dual loop control strategy, the extrusion can be monitored and controlled even more precisely and quickly.

The cost-effective process exploits the benefits of ultrasonic measurement and perfects it in combination with laser scanner technologies. The intelligent solution offered by the ZUMBACH control strategy makes allowance for the product’s properties at the hot and cold ends of the line. It utilises data from the diameter measurement, determined from the ultrasonic eccentricity and wall thickness scanner UMAC®. These data measurements are automatically adjusted based on the data from the ODAC® laser diameter scanner at the end of the line and evaluated. This creates a very fast control feedback loop (due to the short distance from the point of change to the point of measurement) while still basing the control decisions on the final diameter measurements. Using this dual loop, transient deviations can be minimised, in turn leading to a significant reduction in standard deviation and ultimately an increase in the process capability index (CPK).

*Customer specific solution with ODAC® and UMAC® gauges in an extrusion line for products up to 500mm OD*

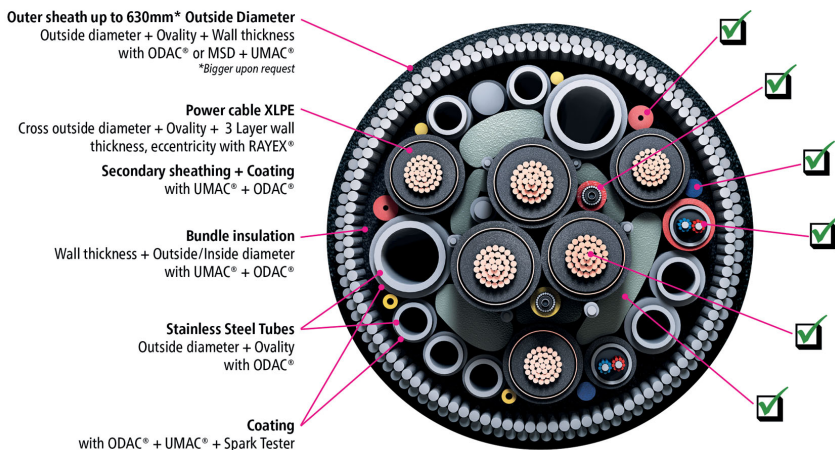



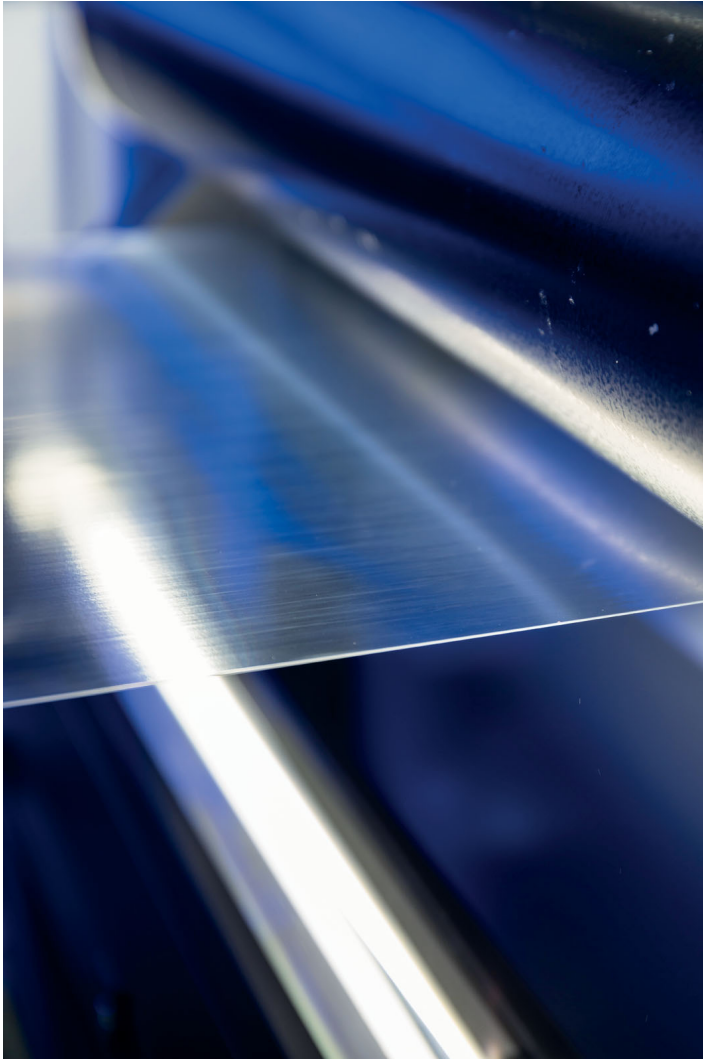

*The innovative lighting concept makes all defect types visible and detects point defects, inclusions, and other defects in any position*

## Inline Inspection System with Pioneering Technology: Application-Specific Camera and Lighting Technology for Immaculate Materials

*Plastics, packaging, and film production – promising markets that harbor great potential. Their application areas, such as the food industry and the pharmaceutical sector, require the highest quality standards throughout the global markets. The resulting requirements for quality control have helped establish ISRA's inspection systems in the sector. Numerous new features are improving the already first-class product – the new embedded camera, developed in-house by ISRA, with optimized detection rate and the even simpler and more reliable handling*

*ISRA's new camera sensor technology now also improves the reliable detection of color defects*

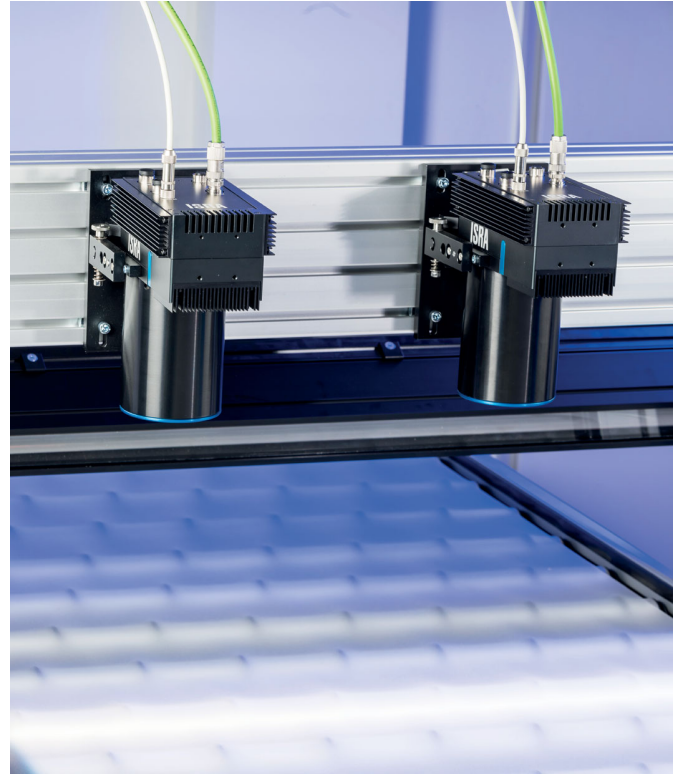

Intelligent automated inspection enables the highest level of quality today. Small, poor-contrast errors and scratches, as well as inhomogeneities in the material, are detected with maximum speed and reliability, thus maximizing the efficiency of the quality control process. The innovative lighting concept makes all defect types visible and detects point defects, inclusions, and other defects in any position.

ISRA's new camera sensor technology now improves the reliable detection of color defects as well, enabling low-contrast defects to be detected and classified more reliably. The high quality of the surface inspection also avoids the detection of false positive defects and enables quality decisions to be made based on reliable facts.

Another decisive factor in the final product grade is the quality of the film coatings: The shine and cloudiness of films provide information on numerous factors that are crucial to quality. Based on methods for measuring haze and gloss developed in-house, ISRA's patented COP (Control of Optical Properties) procedure can be successfully applied to monitor different material properties, such as gloss, cloudiness, or evenness of the coating, throughout the production process and across the entire width of the web. Special ISRA LED rows are used as a point light source and alternately illuminate different areas of the material web. The inspection process takes the differing intensities of the light entering the camera into account, while ISRA's intelligent image processing software converts the variations caused by the changes to the material properties into values for haze or gloss.

In addition to detecting and classifying defects, the inspection system from ISRA also offers numerous new Beyond Inspection modules that complement the system perfectly and maximize its performance. A particular highlight is the new offline recipe optimization, which enables process optimization alongside the ongoing inspection. The recipes are edited, optimized, and tested offline by the operator before being applied to the production process, saving materials and reducing downtimes. In addition, all systems across multiple sites can be managed from a central location, so that performance and quality decisions can be made consistently across all production lines and sites. ISRA's new Real Time Video Analyzer inspects the material produced at an early stage, shortens the commissioning time and reduces the amount of rejects.

With the all-in-one system, manufacturers can increase the quality of their products with maximum efficiency. 100% inline error detection and monitoring of the optical properties also reduce the reject rate. Product data supports decision making at different levels and makes the production processes completely transparent. With its many functions, the system optimizes the production process and quality.

**ISRA VISION AG**  
 Industriestr. 14, 64297 Darmstadt, Germany  
[www.isravision.com/en/](http://www.isravision.com/en/)

*Measurement of inner cross-section geometry with ProfilControl 7 ICSM: New inline system from Pixargus is the first to also measure the rate of recycled material*

*ProfilControl 7 ICSM from Pixargus keeps an eye on maximizing the rate of recycled material in cut plastic profiles produced by co-extrusion. The inline inspection system illuminates the complete internal geometry of the profiles and measures the coating layers and wall thicknesses in a continuous process. In this way it is possible to maximize the use of recycled plastics in profile cores. As a result, production becomes more cost-efficient and the products more sustainable*

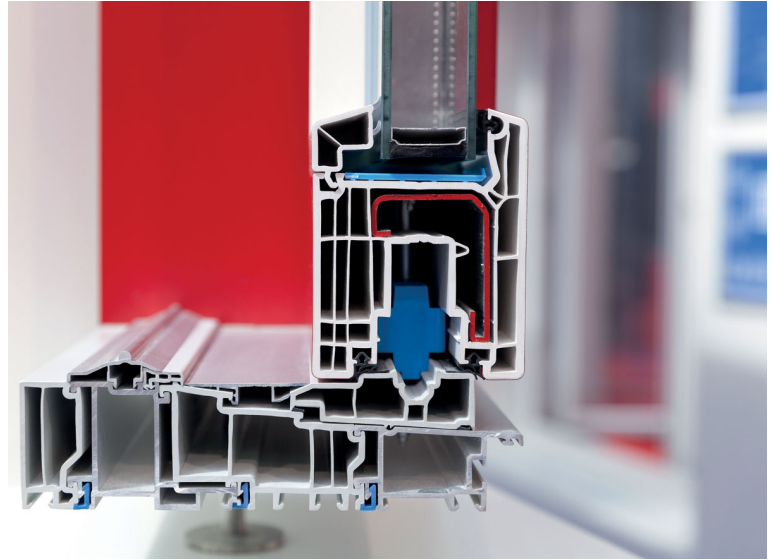

*Today's high-grade recycled plastics are suitable materials for use in the cores of high-tech profiles. (Source: iStock)*

## Inline Measurement of the Inner Cross-Section Geometry of Extruded Products

Today's high-grade recycled plastics are suitable materials for use in the cores of high-tech profiles. While being virtually just as robust and long-lasting as virgin plastics, recycled plastics are more favourable in terms

of cost efficiency and life cycle assessment. This is because recycled plastics can be produced with less energy – reducing the CO<sub>2</sub> footprint – and they are relatively low-priced. ProfilControl 7 ICSM (PC7 ICSM) is the first system

able to measure the rate of recycled plastics in extrusion processes.

### **Highly specialized measuring algorithms: up to the limits of the feasible**

In order to get a grip on the inside geometry of profiles, Pixargus has merged special measuring algorithms into an entirely new measuring concept. Highly specialized algorithms measure not only the coating layers and wall thicknesses, but also the rate of recycled material used. "It has now become possible to increase the rate of recycled material in profile production up to the ultimate limit because the rate is being continuously checked as the profile leaves the cutter," explains Michael Frohn, Sales Manager at Pixargus. The ICSM system is already being used for the inspection of cut window and metal profiles. It is also the solution of choice for the inspection of extruded hoses and tubes, where it can be used in place of conventional ultrasonic measuring systems.

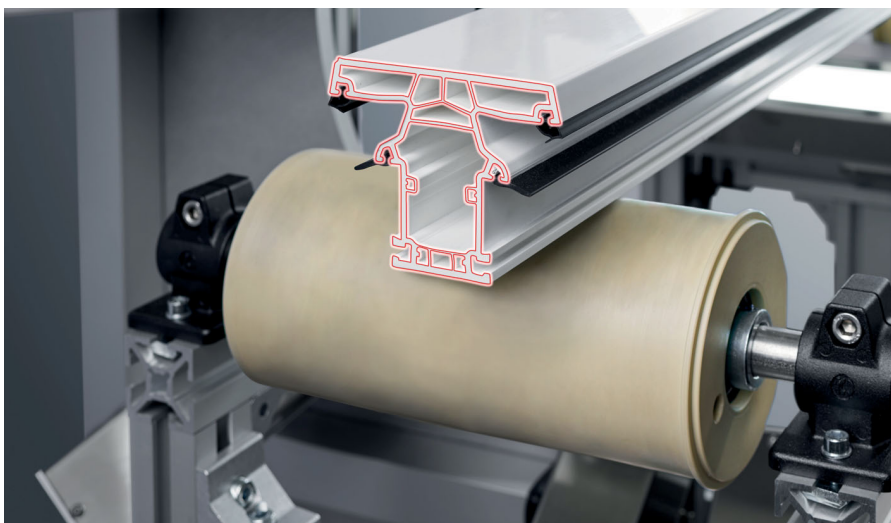

*Pixargus inspects the inner cross section and the clamping sections of cut plastic or metal profiles in extrusion lines directly after the cutting device and, as a first, also measures the rates of recycled materials in the process. (Source: PIXARGUS)*



**100 percent inspected: faults can be corrected in real time**

PC7 ICSM is the first inline gauge measuring the inner cross-section geometry, clamping sections, internal webs, and coating and material thicknesses of cut profiles in extrusion lines directly after the cutting device. Flaws occurring during production can now be detected much earlier and corrected in real time, dramatically reducing out-of-spec production. Another advantage of this innovative technology is that instead of picking random samples, PC7 ICSM checks the inner cross section of all profiles within a batch. "Each profile is 100 percent inspected at each individual cut," adds Frohn. A test log is automatically generated for each piece of profile. The inspection takes place immediately after the cut. Con-

taminations of the measured profile in the form of saw dust or deformations caused by hot cutting techniques (guillotine cutting) are recognized with high reliability and masked out.

**A smart formula: combine 2 systems and get 3 functions**

PC7 ICSM combines ideally with ProfilControl 7 DualVision (DV). The top selling PC7 DV inspects the surface and measures the outside contour of profiles with highest measuring accuracy in one measurement. The combination of two powerful systems leaves no side of the profile uninspected. Arranged ahead of the cutting unit, the DualVision system detects any deviations and anomalies in real time. This allows the production process to be optimized at the earliest



Up to eight high-resolution GigE CMOS cameras measure the inner cross-section geometry of profiles of up to 250 mm diameter. In combination with an upstream installed DualVision system, it is even possible to inspect surface defects and the outside contour in parallel. (Source: PIXARGUS)

Highly specialized algorithms measure not only the coating layers and wall thicknesses, but also the rate of recycled material. (Source: PIXARGUS)

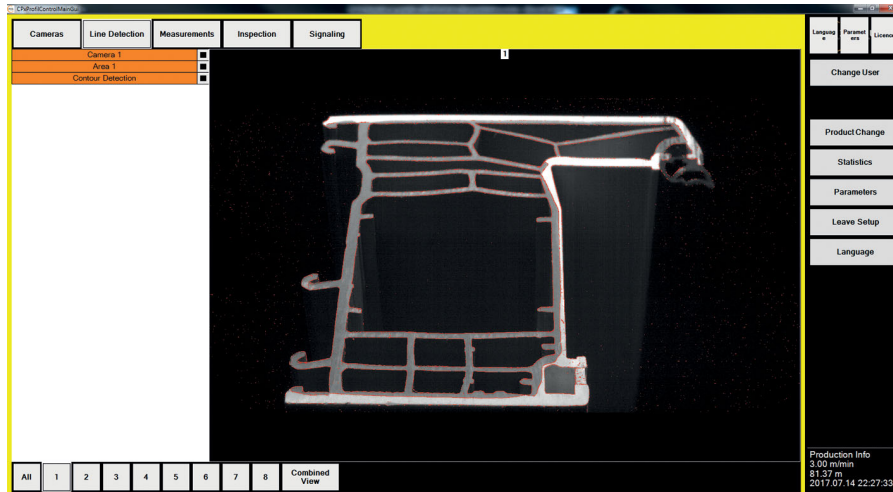

With the PC7 ICSM editor it is now also possible to define inside parameters for the profile production process with pinpoint accuracy. (Source: PIXARGUS)

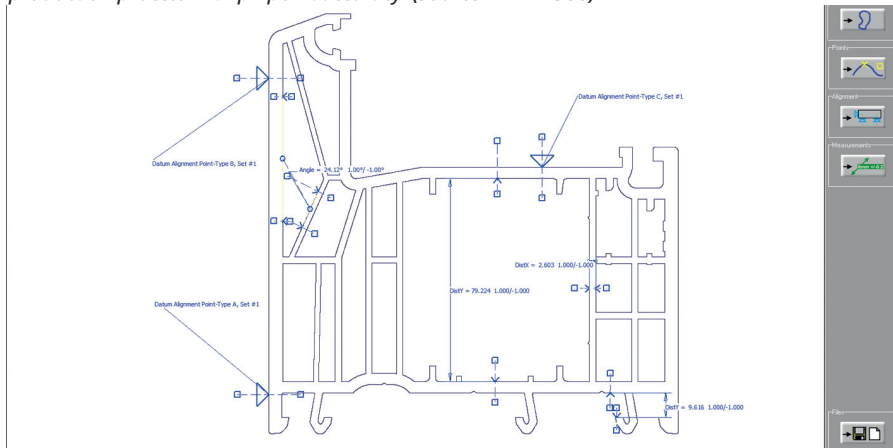

possible point in time and minimizes rejects. The ICSM system checks the inner cross-section geometry of the profiles as they leave the cutting unit and also sorts the cut profile pieces into "good" or "bad", if desired. This guarantees 100 percent quality!

**Inline or stand-alone measuring station**

PC7 ICSM is available as inline system or as a stand-alone, offline measuring station. For the offline inspection of profiles that come as cut pieces, Pixargus offers automated inspection of the surface and the outside and inside contours of profiles all in one unit.

**Perfectly networked**

The inspection system is ready for use in Industry 4.0 environments. It comes with all common interfaces, such as OPC, UA etc, and can be integrated within the closed loop controls of the extrusion line.

**Pixargus GmbH**  
 Industriepark Aachener Kreuz,  
 Monnetstr. 2, 52146 Würselen, Germany  
 www.pixargus.de

# Ultra-fine microperforation sets new standards in melt filtration

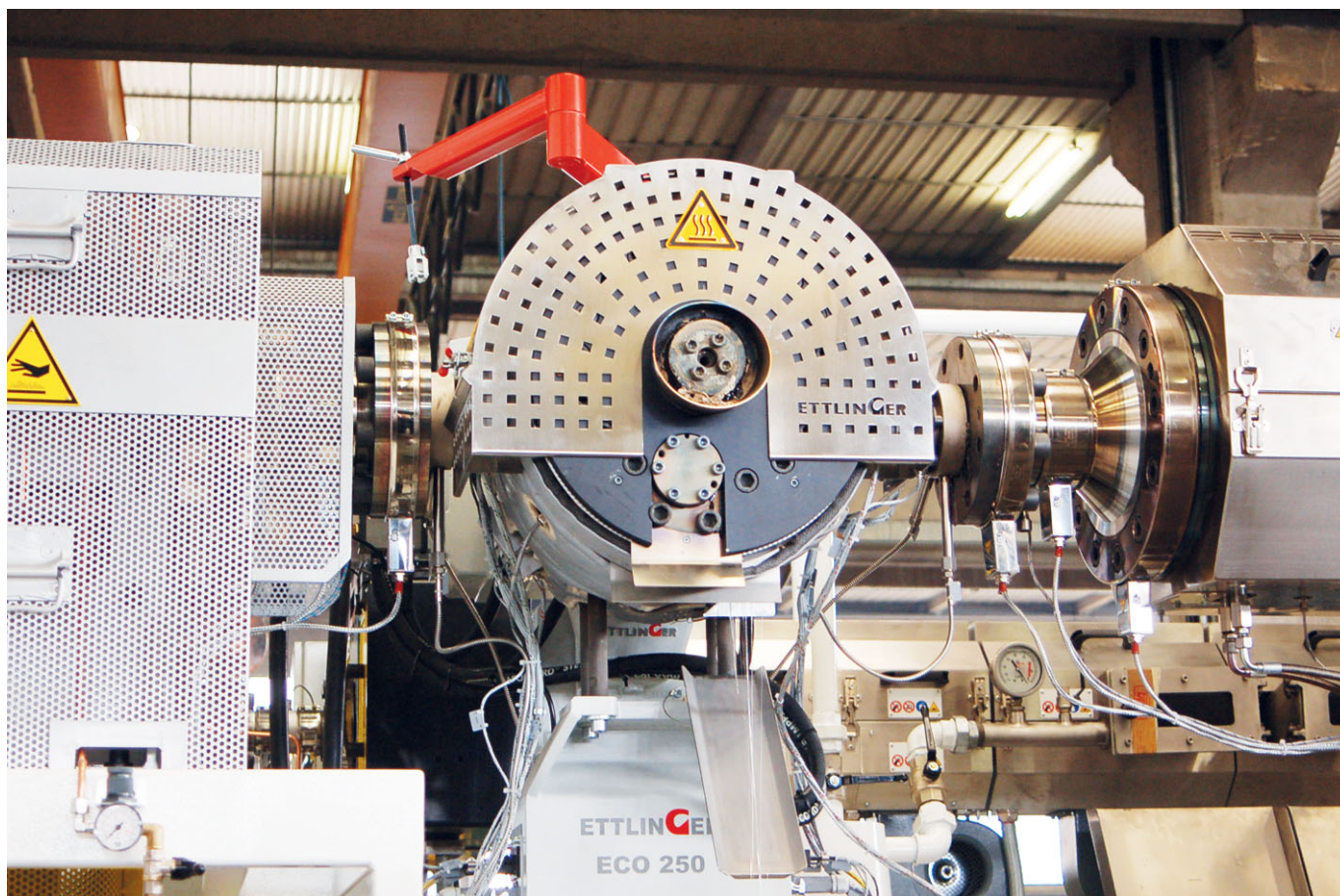

*Thanks to the even smaller 60 µm screen size which is now available for Ettlenger's ECO series, these filters are ideal whenever 100% PET bottle flake is used in thermoform sheets, packaging tape or staple fiber plants (© Ettlenger)*

*With unprecedented filtration fineness of 60 µm, Ettlenger's ECO melt filters will in the future make it easier to treat recycled material for the film, packaging tape and fiber industry and help plastics recyclers remove challenging contaminants like paints, silicones, barrier materials, cross-linked fractions and gels from the melt. In particular, the new filter screens will enable cost-efficient conversion of post-consumer PET bottle flake and fines, which generally occur in large amounts, into recycled material with excellent usage properties*



Recycled PET from post-consumer bottle flake is highly sought-after in the industry as a raw material for thermoforming packaging, fibers or packaging tapes. Against the background of increased environmental awareness, such products are also widely accepted – and in considerable demand – among consumers. Depending on the application, the recycled materials often have to meet high requirements in terms of appearance and / or mechanical properties. For instance, even food packaging made entirely from bottle flake is not allowed to contain any contaminants. Additionally, tapes or yarn which are stretched must not exhibit any defects that could cause them to tear and disrupt production.

The purity of the recycled material is central to its usability. Therefore, in the PET world, the efficiency of the melt filtration process is far more critical than usual on the recycled material production line. The screen changers and screens normally employed for this purpose have limitations here, whereas Ettlenger's self-cleaning ECO filter systems permit compliance with even the toughest specifications. The core component of the ECO filter is a rotating, cylindrical steel screen with millions of conical holes drilled by laser. When melt flows through this screen from the outside to the inside, any contaminants are retained on the surface and continuously removed by a scraper. The decisive breakthrough as far as PET recycling is concerned was the recent market launch of a microperforation with an unprecedented filtration fineness of 60 µm.

#### **Limitation of woven steel mesh screens**

Woven steel mesh screens are made of fine metal wires. A square mesh is the simplest and most commonly encountered type. The side length of the openings corresponds to the screen's nominal mesh size. However, in practice, a square mesh allows much larger particles (factor 1.41) to

pass owing to the diagonal. Furthermore, the individual wires are only linked together loosely. As the filter cake grows and the pressure rises, some meshes may be enlarged, so that particles bigger than the nominal mesh size slip through.

Contaminants contained in the PET bottle flake such as aluminum or paper as well as "black specks" – black, degraded plastic particles that occur during the process – regularly find their way into the recycled material. The resulting scrap pushes up the cost.

This also has negative impacts on the downstream extrusion process because the build-up of a filter cake on woven steel mesh screens accompanied by strong pressure fluctuations and the need for frequent screen changes creates extra work, as does cleaning with a reverse melt flow (backflush).

#### **Lasered microperforation is the answer**

These traditional woven steel mesh screens contrast with Ettlenger's rigid filter screens, whose laser-drilled microperforation impresses with much better separation efficiency. The woven steel mesh screens have a mesh size corresponding to the cross section of the conical holes in the filter screen, which are tapered in the direction of the melt flow. When melt flows through the screens, all contaminants larger than the hole diameter are retained on the filter surface. Thanks to the new 60 µm filtration fineness, the few residual contaminants are no longer visible to the human eye. The PET recycling process also has the basic ability to convert recycled material into new products with visual, mechanical and organoleptic properties that are indistinguishable from virgin material. The significantly reduced occurrence of black specks and other particles helps make the line more efficient because there are virtually no torn tapes or fibers; ultimately leading to substantial savings.

Added to this is the system-specific advantage of all Ettlenger-built melt filters, namely the continuous, constant filtration efficiency over several weeks or months without any process interruptions. They work according to the principle that contaminants are removed from the microperforated filter screen by a scraper, and immediately discharged, with every rotation. The filtration surface remains absolutely clean as a result and the melt filter works with a constant pressure for exceptionally long periods. Contaminants such as small elastic particles like silicone etc. which could otherwise be forced through the screen after a while, are unable to collect on the surface.

#### **Previously unused material flows acquire commercial value**

Ettlenger's continuous melt filters regularly open up new possibilities for materials that have traditionally been considered too heavily contaminated or that contain extremely problematic contaminants. The new 60 µm filter screen makes the use of PET fines from recycled bottles an even more commercially attractive option. These fines occur during the sorting, grinding and washing processes and tend to be contaminated with large amounts of paper and aluminum. Although up to 20 tons of fines per month are generated even in small PET bottle recycling plants, this material is sold at a low price for want of an alternative. Ettlenger's continuous, high speed ECO melt filter will let customers convert their PET material flows into an even higher quality – and hence more profitable – end product.





*The RV 53d pressure forming machine enables economic and hygienic thermoforming of different batch sizes also with PP*

## Pressure Former for Hygienic and Cost-effective Production of PP Packaging

The German manufacturing company ILLIG is a leading global supplier of thermoforming systems and mold systems for thermoplastics. With its unique 360° packaging development, Pactivity®, and its high-performance packaging systems, ILLIG supplies its customers with resource-friendly and sustainable solutions. At IndiaPlast ILLIG showed the latest RV 53d pressure former with 3 bar support for high output of perfect thin-walled thermoformed parts out of i.e. PP, PS or PET. On the booth, the RV 53d with print mark control – a USP for this machine segment in India – produced lids made of PP film, which can also be pre-printed.

Lightweight PP packaging for easy recycling: Plastic is the ideal material for hygienic, durable and secure food and non-food packaging. In particular, thin-walled packaging made with PP offers benefits for consumers and vendors alike. At the exhibition ILLIG presented the production of thin-walled PP lids for easy recycling (one-stop solution) without the need for other branding media such as paper or plastic sleeves.

Benefits of ILLIG thermoforming: The benefits of a thermoforming production line RV 53d from ILLIG are unmistakable: Thin-walled packaging means tangible savings in raw materials and thus lower production costs. The high working cycle results in a high output of flawless formed parts and the thermoforming molds with multiple cavities are comparatively inexpensive to make and can be quickly and easily exchanged. With a connected stacking station, the thermoformed plastic parts can be hygienically stacked without any undesirable contamination (no human contact).

The demand on the Indian subcontinent for affordable high-quality plastic packaging according to European standards that are also suitable for export is growing at a steady rate. More and more packaging suppliers and subcontractors for large international brands have recognized the market trend and decided to invest in thermoforming.

ILLIG India expands production: The ILLIG India Pvt. Ltd. production plant in Malur, some 30 km east of Bengaluru, has already been supplying the Indian market for over three years with RV 53 automatic vacuum forming machines with separate forming and punching. ILLIG India expanded its capacity by adding the RV 53d pressure former series as well as the sheet processing machine UA 100Ed. This machine is designed for small and medium batch sizes. Get the latest information about this thermoforming machine with manual loading at a very reasonable price-performance-ratio.

ILLIG RV 53d pressure former: The RV 53d stands for high performance and formed part quality – even for complex part geometries. Short cycle times and a high degree of automation during the forming, punching and stacking processes, combined with sophisticated quick-release retooling technology, enable high availability and the required high productivity. The RV 53d is able to process a



*Everything you need for sustainable and successful production and a permanent competitive edge: The RV 53d with print mark control – a USP for this machine segment in India – produces lids made of pre-printed PP film*

wide range of material films including i.e. PP, PS or PET. The basic version of the RV 53d is equipped with heating, forming and punching stations, and it can also be upgraded to include a stacking station. Its standard heating and material transport enable seamless processing of PP material film. A modular preheater can also be included for applications that require a preheated material film. Short filling times for individual cavities make shortened cycle times possible with optimally defined formed parts. The upper and lower tables can be supplied with forming air or vacuum as required. The entire forming pressure is available in the shortest of time thanks to shortened forming air channels. This increases the forming dynamic and the forming definition of the mold cavities. Through servomotor-driven pre-stretching of the heated material film the part is formed very evenly and consistently along the entire part contour. PP material film is processed at 3 bar with material spreading and enhanced cooling performance.

RV Machines for Economic Batch Sizes: The RV machines from ILLIG stand for simplicity in mold technology design for forming, punching and stacking thermoformed parts. This enables the customer to be able to construct his own simple-design forming and punching tools according to his own requirements and at a very low cost. ILLIG's manual for mold making that was designed specifically for this machine type lets customers realize the machine's full potential; ideal conditions for manufacturing formed parts economically and efficiently, even for small series production. The included mold making manual will also help the Indian toolmakers as well as customers with their own moldshop to create complete forming tool sets. ILLIG India provides the necessary technical support to both customers and toolmakers in India.

# Safer Food – Less Waste

*1.25 meter wide film substrate  
on the roll-to-roll coating line atmoFlex 1250  
(© Fraunhofer FEP)*

*At ICE europe 2019, the Fraunhofer Institutes for Applied Polymer Research IAP, for Interfacial Engineering and Biotechnology IGB and for Organic Electronics, Electron Beam and Plasma Technology FEP presented innovative technologies for sustainable food packaging. They each have extensive expertise in processing, process development and control, the development of special polymer films and the deposition of ultra-thin layers for the packaging industry*



*Biobased film for sustainable packaging (© Fraunhofer IGB)*

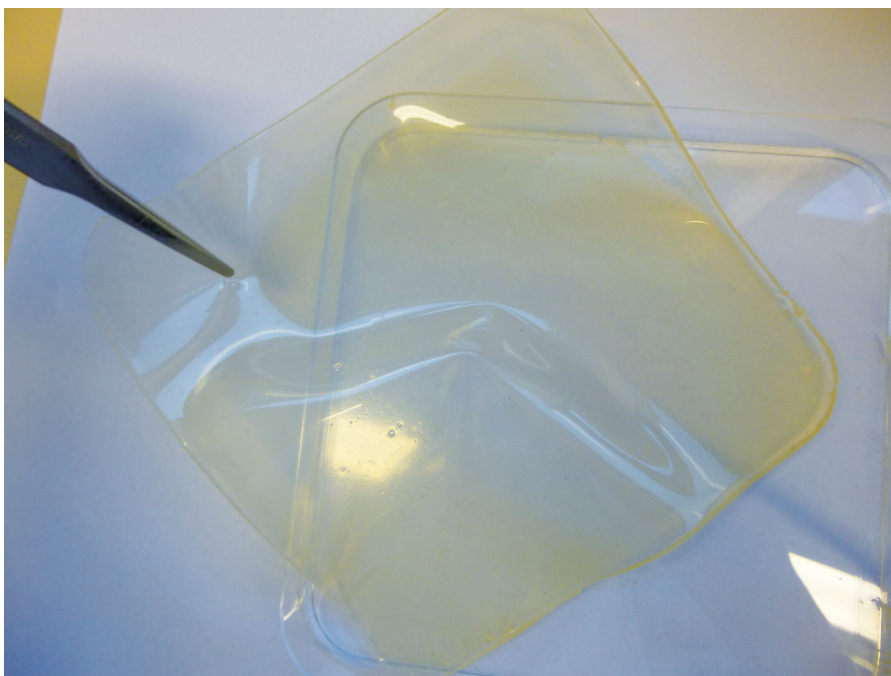

The topic of product and food packaging is more relevant and more present than ever. Almost everyone already has the image of the immeasurably large plastic vortex in the oceans in mind when shopping and selecting plastic-packed meat or vegetables. At the latest when food is stowed at home, the amount of outer packaging becomes clear. The figures from the Federal Environment Agency speak for themselves – in total, every German produces around 220 kilograms of packaging waste annually.

A complete avoidance of packaging film, however, is hardly feasible. Hygiene standards, transport routes and ultimately the purchasing behavior of customers with regard to fresh food at affordable prices require hygienic, functional and safe packaging, because bacteria, viruses



and moulds can easily spoil food everywhere and can also cause serious illnesses.

#### **Nanotubes with antimicrobial essential oils**

The EU joint project “NanoPack”, launched in 2017, focuses precisely on these challenges and aims to develop state-of-the-art antimicrobial packaging solutions for perishable foods based on natural nanomaterials in order to prevent outbreaks of food-borne diseases and reduce food waste due to early spoilage. The economic aspect of production, upscaling and validation (including regulatory requirements) was also considered in order to produce marketable and cost-effective food packaging.

Halloysite nanotubes (HNTs) for use in food packaging are being investigated as the basis for developing the new packaging solutions in the NanoPack project. By modifying the surface of this nanomaterial, essential oils such as thyme oil can be efficiently released integrated into a packaging film. The essential oils released as steam reduce the growth of microbes both on the product surface and in the packaging room. The scientists at Fraunhofer IAP play a leading role in the development of treatment processes and the surface functionalization of HNTs as well as in compounding, i.e. the integration of particles – loaded HNTs – in polymer films.

#### **Measuring layer thickness with fluorescent inks**

Process control methods are also relevant in this context, which Fraunhofer IAP will also present. In the production of thin, transparent layers, such as in packaging films, in-line process control can contribute to quality assurance and improvement and expensive material components can be used efficiently. Through complete monitoring, the manufacturing process can be optimized in such a way that only as much of a functional component (e.g. an oxygen barrier layer or a laminating adhesive) is used as is necessary for its function, which can lead to considerable material and cost savings. Fluorescent dyes are used as additives in the functional layer in order to measure the distribution of the layer thicknesses by measuring the fluorescent light. The dye is added to the coating material in such small quantities that it is not visible and the material properties are not affected. By combining novel packaging materials with effective process control, scientists aim to make future food packaging safer and at the same time cheaper.

#### **Multilayer barrier layers against oxygen and water vapor**

The scientists at Fraunhofer IGB are also working on processes for functionalizing packaging films. In order to be able to produce the widest possible range of surface proper-

ties, IGB is pursuing the approach of functionalizing polymer films using plasma/CVD and wet-chemical processes – or combinations of these technologies. This creates barrier layers against the permeation of oxygen and water vapor for outer packaging as well as barrier layers that prevent the release of polymer additives from the outer packaging into a food or pharmaceutical product.

The challenge here is that the layers must be elastic to a certain extent so that they do not break or crack on the polymers. The Fraunhofer researchers therefore realize the coatings in the form of several mechanically decoupled layers, which are successively deposited “layer by layer” in the plasma. “By optimizing various plasma process parameters such as the type and quantity of precursor gas used, the excitation frequency, the gas flow, the pressure and the treatment time, we can successively produce glass-like layers with the desired barrier function and silicone-like elastic intermediate layers”, explains Dr. Jakob Barz, group leader for “Plasma Technology and Thin Films” at IGB. In this way, the researchers were able to increase the barrier effect of plastic films against water vapor and oxygen by a factor of up to 1000 compared to untreated material. The deposited barrier layers can also be combined with another layer to improve food run-off when emptying a film package.

#### **Biobased barrier layers**

Currently, Fraunhofer IGB is also conducting research on biobased layers with a barrier function against oxygen and water vapor. At ICE Europe, the institute presented the first barrier coatings and films that consist of 100 percent natural starting materials and also have antioxidant or antimicrobial properties. “We produce these films and coatings from a newly developed water-based dispersion that contains natural waxes and proteins. The

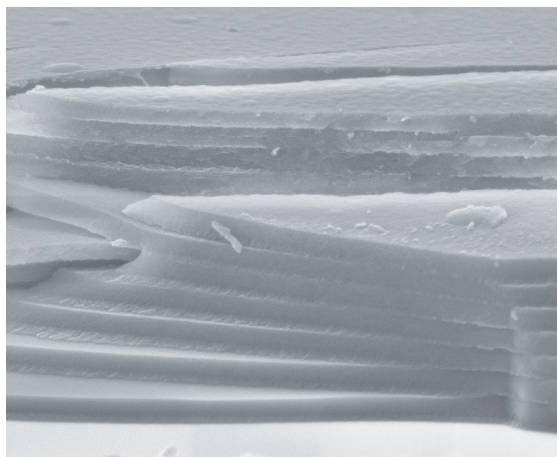

*Multilayer coating as barrier against oxygen and water vapor  
(© Fraunhofer IGB)*

dispersion can be processed using conventional coating techniques,” explains Dr. Michaela Müller, head of the IGB research group “Polymeric Interfaces and Biomaterials”. The big advantage is that the layers are also 100 percent degradable and can thus help to reduce plastic waste. The development is part of the IGF project BioActiveMaterials, in which the Fraunhofer IVV is also involved.

#### Functionalization for lamination and adhesion

The Stuttgart/Germany researchers are modifying polymer films with specific chemically functional groups in order to change surface properties that are required for subsequent process steps such as adhesion. Amino functionalization can also be limited to the edge area of packaging films using gas-phase and wet-chemical process steps and used for laminating the films.

#### Safe food through physical disinfection

For a longer shelf life of food, the packaging must be free of contaminating germs. Depending on the material, microorganisms on packaging are usually inactivated by heat, gas, ionizing or UV radiation. Low-temperature plasmas used at IGB are a material-friendly alternative to sterilization at high tempera-

*Green fluorescence of a dye solution excited with blue light (© Fraunhofer IAP)*



tures. They are not only suitable for creating layers, but can also inactivate microorganisms due to reactive molecules and UV radiation in the plasma process. “With plasma sterilization, even highly resistant endospores of different *Bacillus* species become unable to reproduce after relatively short treatment times”, says Barz.

In addition, scientists at Fraunhofer IGB have further developed UV treatment in order to minimize the number of reproductive microorganisms on surfaces. With new, specially designed excimer lamps or the latest UV LED technology, packaging films can be sterilized quickly and effectively. These processes can be scaled up on packaging machines and adapted to individual requirements.

#### Rollcoater for high-speed finishing

The market for packaging films is extremely price-sensitive. Fraunhofer FEP devotes itself to this aspect by developing highly productive finishing processes, which are characterized in particular by very high speeds. One example is the production of transparent barrier layers of aluminum oxide against external influences such as moisture or oxygen on plastic films using plasma-activated high-rate deposition at web speeds of several meters per second. Therefore, Fraunhofer FEP operates so-called roll coaters, which can efficiently coat film material with a width of up to 700 mm and web lengths of several kilometers. The researchers are currently working on qualifying this established technology for use on biobased materials.

A further example is the modification of polymer materials when they already exist as films. For this purpose, Fraunhofer FEP operates a roll-to-roll system that uses electron beam irradiation to modify the structure of the polymer molecules. Effects such as the adaptation of the modulus of elasticity or the thermal resistance can be achieved. The

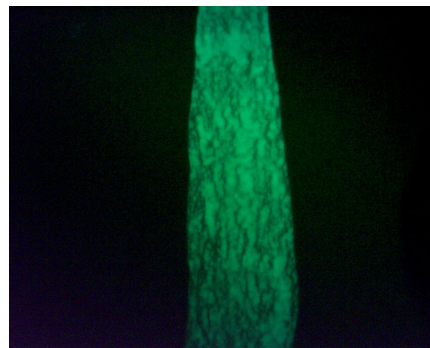

*Fluorescence of a lacquer strip*

proof for fossil-based polymer films has already been provided in the past. The extent to which the effects can also be determined with biobased materials is currently being investigated. Dr. Steffen Günther explains: “This treatment takes place at atmospheric pressure and not under vacuum. The pilot plant at Fraunhofer FEP atmoFlex 1250 is used for this purpose. Due to its web width of 1250 mm, a high throughput in the treatment of films at web speeds of up to 150 m/min can be achieved. Both aspects allow a very cost-efficient processing of the films.”

With their research, the three Fraunhofer Institutes want to make a significant contribution to waste avoidance. While at the same time increasing the shelf life of food, the approaches presented for the development of biobased packaging films are intended to generate positive benefits for customers, the environment and producers.

The scientists from the Fraunhofer Institutes IAP, IGB and FEP presented the research results, the latest coated packaging films and the first packaging film with encapsulated essential oil at ICE Europe in Munich, Germany.

► Fraunhofer-Institut für Organische Elektronik, Elektronenstrahl- und Plasmatechnik FEP  
Winterbergstr. 28, 01277 Dresden, Germany  
[www.fep.fraunhofer.de](http://www.fep.fraunhofer.de)



# IPTF<sup>2019</sup>

## 7<sup>th</sup> INTERNATIONAL POLYMER TECHNOLOGY FORUM

June, 4-5, 2019  
AZIMUT Hotel  
St. Petersburg,  
Russia

### PRACTICAL SOLUTIONS FOR PLASTICS PROCESSING

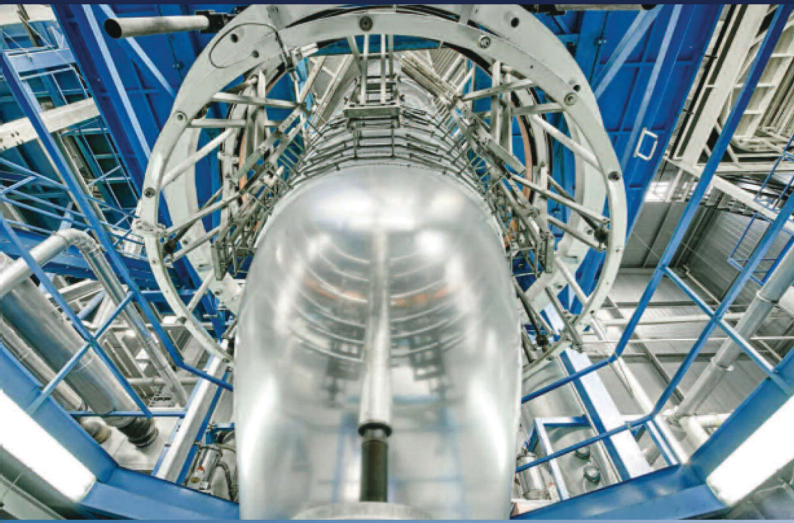

More than **60** plastics processing companies

More than **180** participants



#### KEY ISSUES

- Reduction of unplanned downtime and repairs - online diagnostics, monitoring and service.
- Digital transformation of a polymer industry enterprise - how to start?
- Modernization of equipment: from idea to implementation. How to avoid mistakes?
- What are the reserves for optimization at each stage of production (transportation, dosing, mixing, heating or cooling, extrusion or injection moulding, quality control, etc.)?
- "Lean" in the processing of plastics

SEPARATE PARALLEL SESSIONS for polymer processors by the methods of EXTRUSION and CASTING – producers of films, pipes, PVC profiles, plastic containers and other polymer products – for each group of manufacturers - the subtleties of technologies and processes, raw materials and additives, equipment and individual components, discussions, experience and exchange of views. We know that you are interested.

#### Organizers

**F** PR.EVENTS

**EXTRUSION**

**ОПЛАСТИК**  
RUSSIA & INTERNATIONAL PLASTICS EXHA

#### Contacts

<http://iptf.extrusion-info.com>

**in Germany** +49 2233 949 8793  
a.kravets@vm-verlag.com

**in Ukraine** +38 098 1226234  
info@fprevents.com

**in Russia** +7 499 346 68 47, info@iptf.ru  
+7 917 011 45 47  
russia@vm-verlag.com  
+7 846 276 40 45  
reklama@plastics.ru



# SMART EXTRUSION

The only website collecting information about smart technologies of extrusion

VVA VERLAG

English

SMART  
EXTRUSION  
THE EXTRUSION WEB PORTAL

Search...

NEWS MAGAZINES ADVERTISE SUBSCRIPTION TRADE SHOWS ABOUT US

ABOUT EXTRUSION FOR THE WHOLE WORLD



Extrusion 4-2018

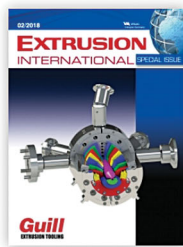

Extrusion International 2-2018



Extrusion Russia 2-2018

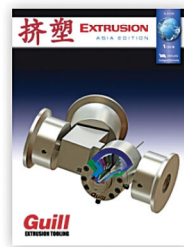

Extrusion Asia 1-2018

— MEDIA KIT —



CHOOSE YOUR  
BANDERA



— TOP STORIES —

ARTICLES

A SPECIALIZED WEB PORTAL

- ▶ News about relevant products and events
- ▶ Detailed reviews of various smart technologies
- ▶ Case studies from processors
- ▶ English, German, Russian and Chinese
- ▶ Video clips demonstrating smart equipment in live action
- ▶ Latest magazines available for reading and downloading
- ▶ Weekly e-mail newsletters

**23 800 + average monthly visits**

Geographic distribution of Smart\_Extrusion readers, %

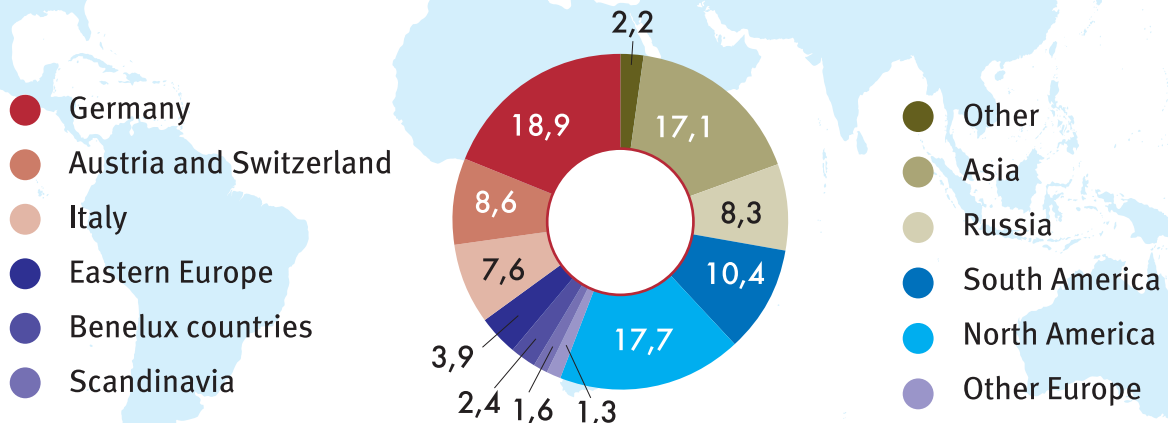

[www.smart-extrusion.com](http://www.smart-extrusion.com)