

04/2022

VA VERLAG  
Cologne /Germany

# EXTRUSION INTERNATIONAL

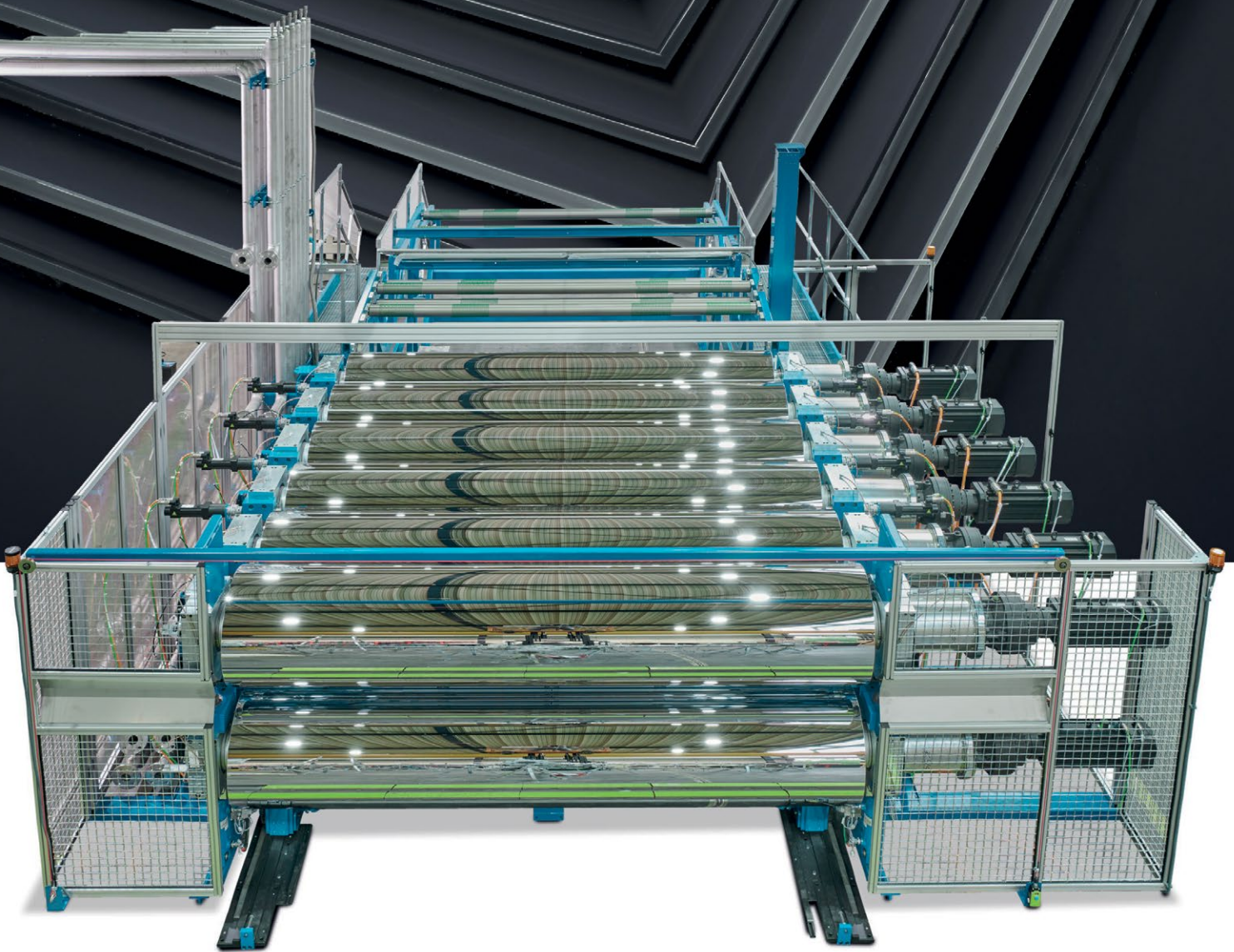

multiTOUCH XXL  
The smart way of board extrusion.  
[www.battenfeld.cincinnati.com](http://www.battenfeld.cincinnati.com)

Process engineering for  
efficient plastics extrusion  
of tomorrow.

battenfeld-cincinnati 

## Stein Profile Stacker

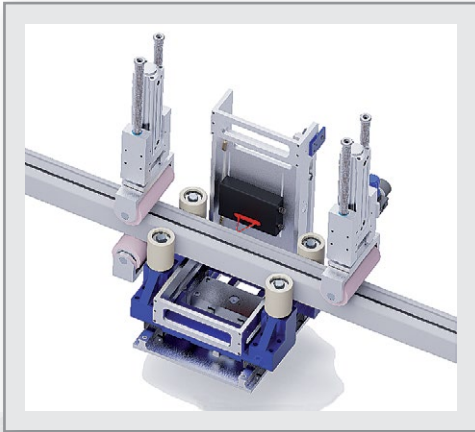

### Profile length measurement during extrusion

Measuring sensors are used to determine the length of individual profiles before a profile layer is formed.

The measured length can be used to check and correct the cutting device of the extrusion line or for documentation (quality assurance) of the produced profile lengths.

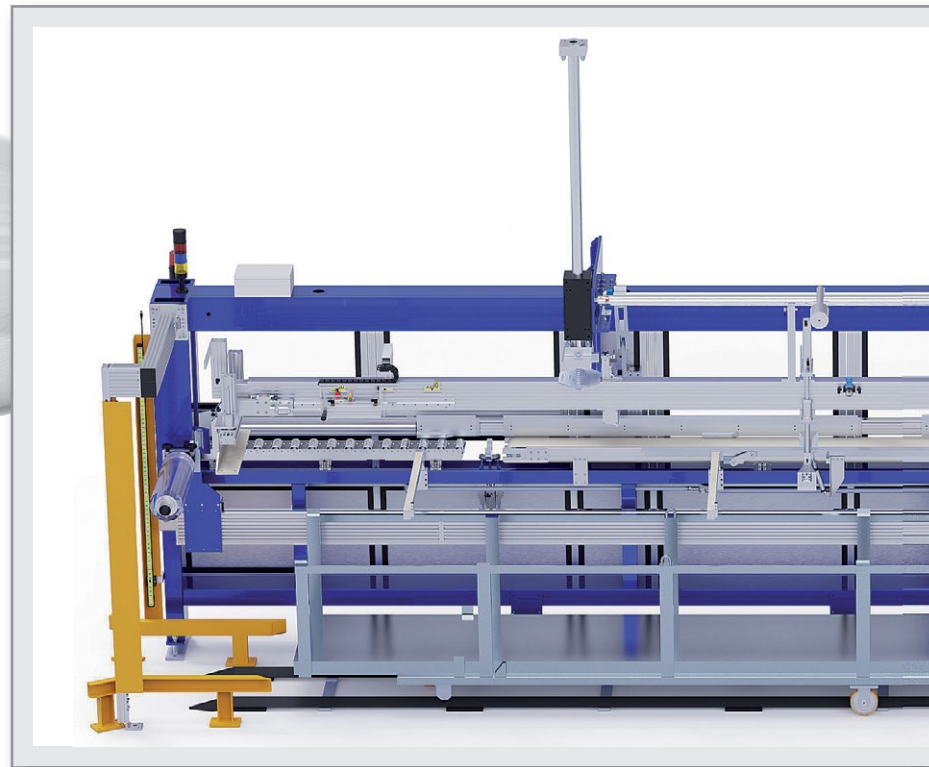
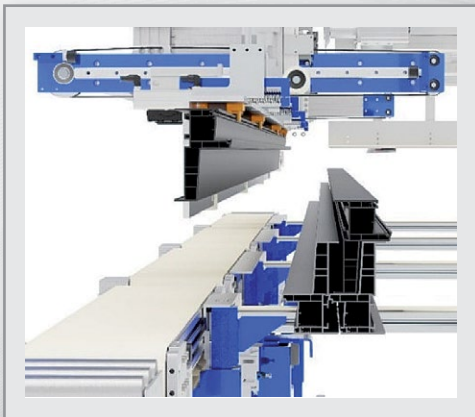

### Stacking of special profiles

Stein Maschinenbau offers technical solutions for stacking of heavy and large monoblock profiles.

Based on decades of experience, we can unusual profile geometries or special layer can be evaluated for their automated stacking.

### Cassette spreader

With the help of a cassette spreader it is possible to realise the same packing density of the manual packaging.





19 - 26. 10. 2022  
Düsseldorf, Germany  
Hall 16, Stand F 15



## Stein Profile Stacker



### Weight determination during extrusion

With the help of special weighing units, individual profiles can be weighed before a profile layer is formed. The determined weight can be used to optimise the extrusion.

**As a specialist in the field of special machine construction, we always find a solution!**



### Cassette handling

The handling system allows empty cassettes to be fed into the automatic stacker and the filled cassettes to be pushed out.

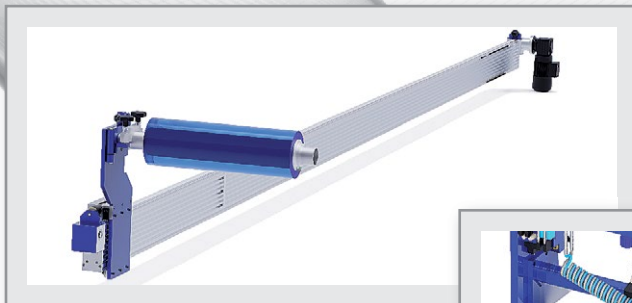

### Profile interlayer

Endlessly laid as a foil between the profile layers or with individual strips laid on the layer.

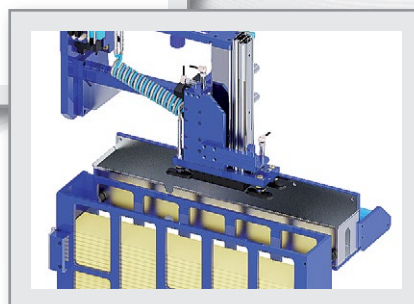

**STEIN Maschinenbau  
GmbH & Co. KG**

Wartbachstrasse 9  
66999 Hinterweidenthal/Germany  
Tel. (+49) (0)63 96-9215-0  
Fax (+49) (0)63 96-9215-25  
stein@stein-maschinenbau.de  
www.stein-maschinenbau.de

Firms in this issue	6	Call for Closing the Loop on Plastics and Beyond	30
Imprint	7	Growing Revenues, Plant Sizes and Production Capacities	30
<b>Industry News</b>	8	Extrusion Coating and Laminating Line Installed	31
Calendar	8	<b>K 2022</b>	
The Halls are Packed: This is interpack 2023 wire and Tube 2022 – Sustainability a Much-Debated Topic in the Exhibition Hall	9	Global Plastics and Rubber Industry Jointly Active for Climate Protection, Circular Economy and Digitalization	32
SPE Thermoforming Division announced 2023 Conference	9	Messe Düsseldorf Ensures Highest Air Quality	32
PLASTPOL 2022	10	The Italiens at K 2022	33
Supply of Slitter Rewinders and Outlook for Additional Lines Thanks to Relationship with Chinese BOPP Film Giant	11	Complete Lines for the Entire Extrusion Industry	34
Over 20 Thousand Visitors at the First Edition of Greenplast	12	Intensive Cooling „Short Stack“ Technology	36
AMAPLAST Assembly	12	Using Sustainability as a Success Driver, Benefiting from Digitalization, Increasing Productivity	37
Acquisition	13	Smart Solutions to Increase the Sustainability of Film Stretching Lines	38
European Plastics and Rubber Machinery Industry Fall Shy of Global Production Growth	14	Technology Innovations at K 2022 – Higher Plant Efficiency for Sustainable Film Production	39
Multifunctional Coating Line	14	Sustainable and Digital	40
New Distribution Partner	16	New System to Improve Pellet Cooling and Ejection	41
Series of Explosion-Proof Roots Pumps Expanded	16	Circular Economy: Digitalization Makes the Decisive Difference	42
Strategic Start-Up Investment	18	Full Range of Plant-Based Polymer Additives	43
Global Footprint expanded with the Construction of a New Production Facility in Austria	18	Sustainable Machinery Performance and Smart Factory	44
Chief Procurement Officer Appointed	20	„Quality Works“	45
Executive Vice President of the Digital & Service Solutions Division Appointed	20	<b>Sheet Extrusion – Case Study</b>	
New Head of Corporate Communications and Marketing	20	Multi-Touch Roll Stack is Good for our Feet	46
Plastics Recycling Awards Europe 2022	21	<b>Pipe Extrusion – Interview</b>	
Vice President for Canadian Operations Appointed	21	Trends in the Extrusion of Plastic Pipes	48
Chief Information Officer Appointed	21	<b>Measuring Technology</b>	
Acquisition	22	CENTERWAVE 6000 – Now Also for Pipes up to 1,200 mm Diameter	50
Stake in Start-Up Company	22	<b>Pipe Extrusion</b>	
New CEO	24	Presence in Italian Market Strengthened with Top Technology Solutions	51
New 800 Series Hybrid Extrusion Tooling Announced	24	<b>Circular Economy – From Research</b>	
New Board Elected	25	Achieving Sustainability Targets by Digital Means	52
Market Study – Fillers	25	<b>Material Handling, Recycling</b>	
Major Investment in Europe’s Capacitor Film Production	26	Innovative ZS-B MEGAfeed Side Feeder Makes Plastics Recycling Markedly More Economical	54
Advanced Web Transfer Device Patented	26	<b>Sheet Extrusion</b>	
Rotary Extrusion Dies with 2X Increase in Speed	27	Bundled Expertise for the Production of Alternative Polyolefin-Based Floor Coverings	56
PET Washing Systems in Demand	27	<b>Pipe Extrusion</b>	
„Be A Waste Transformer“	28	Belling Machine Forms Rieber Socket in PVC-O Pipes	58
Inspection and Classification – Effective Evaluation & Distribution of Raw Materials	29		





36

Addex will launch the latest iteration of its patented Intensive Cooling™ technology, the "Short Stack," at the upcoming K 2022 exhibition in Düsseldorf, Germany



43

Palsgaard will take the opportunity of K 2022, to position itself as a preferred supplier to polymer producers, masterbatch manufacturers and compounders seeking to lower their carbon footprint and go renewable

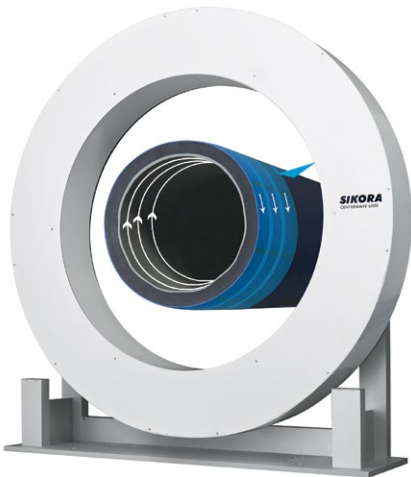

50

SIKORA offers the CENTERWAVE 6000 for the measurement of wall thickness, inner profile and diameter as well as ovality of plastic pipes. Now a new model is available



51

Tecnomatic increases its presence in the Italian market with the agreement to supply a new line for multilayer polyethylene to the company Riccini, an historical company in the panorama of the production of Italian plastic pipes

In cooperation with ExxonMobil and additional development partners, KraussMaffei has successfully completed the in-house project for the production of alternative PP-based floor coverings in its R & D center in Hannover, Germany

56

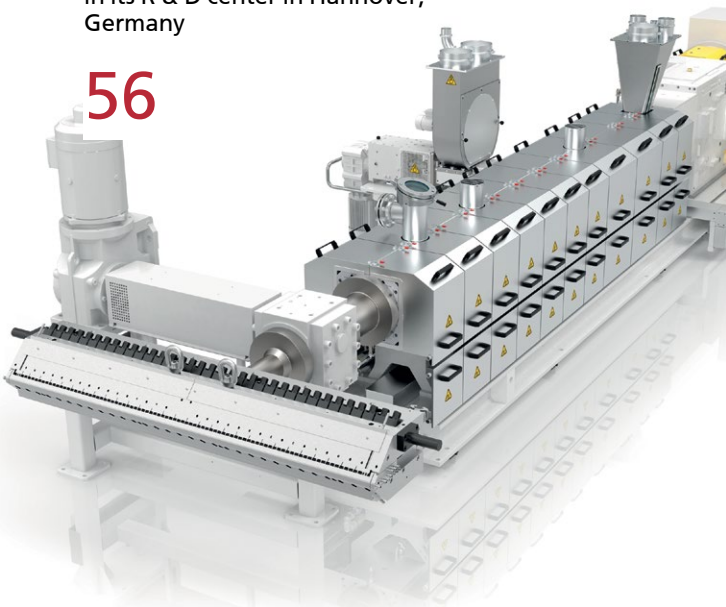

SICA has developed an innovative Rieber belling process, specific for PVC-O pipes (oriented molecule PVC pipes). At the same operating pressure, these pipes require a wall thickness of about 35 to 40% less than those in PVC-U and allow the construction of water supply pipes up to 25 bar of operating pressure

58

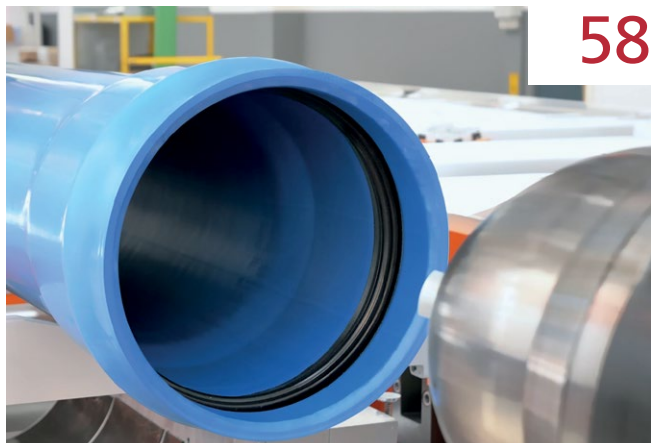

## Index of Advertisers, companies and *fairs* referred in this issue

Addex	36	interpack 2023	8
AKRO-PLASTIC	16	K 2022	32
AMAPLAST	12, 33	KIEFEL	40
A Più	33	KraussMaffei	20, 42, 56
battenfeld-cincinnati	OutsideCover, 34, 46	Lab-Conference	Outside Back Cover
BB Engineering	47	LANXESS	45
Bausano	48	Lindner-Recyclingtech	28
Beier	23	MAAG	41
Brabender Technologies	22	Messe Düsseldorf	8, 32
Breyer	17	motan-colortronic	7
Brückner Maschinenbau	26, 39	Nanjing Lexun	55
Brückner Servtec	38	NGR	24
Brüggemann, L.	13	OCS	29
CCA	11	Palsgaard	43
Ceresana	25	Pfeiffer Vacuum	16
CLASSEN	46	PLASTPOL 2022	10
Coperion	49, 54	Popular Aseptic Pack.	31
Davis-Standard	21, 26, 31, 44	port F	18
EREMA	22, 30	Reifenhäuser Group	37
EUROMAP	14	SICA	58
European Bioplastics	25	Sikora	50
Extreme Coatings	18	Smart-Extrusion	53, 57, Inside Back Cover
Fujian Forop	10	SML	14
Gneuss	21	SPE Thermoforming	9
GREENPLAST	12	Stein Maschinenbau	Inside Front Cover+3
Guill Tool	24, 25, 27	Tecnomatic	51
Herbold Meckesheim	27	TOMRA	30
Hillesheim	19	Tube 2022	9
IKV-Aachen	52	Vetaphone	20
IMCD-Group	16	wire 2022	9
IMS	11	Zumbach	15



## Follow the news in the world of extrusion!

Subscribe to digital magazines  
and Smart Extrusion weekly newsletter

- **Just** submit your **e-mail address**.
- Digital magazines and news updates **free of charge**
- No spam. Your data is safe



[www.extrusion-info.com/subscription](http://www.extrusion-info.com/subscription)



04/2022

VM VERLAG  
Cologne / Germany

# EXTRUSION INTERNATIONAL



The Extrusion International Magazine is published bimonthly by VM Verlag GmbH. P.O.Box 501812, D- 50879 Cologne, Germany

## EDITORS

Bettina Jopp-Witt (Editor-in-chief)  
Tel. +49 221 546 1539  
redaktion@vm-verlag.com

Dmitry Kosuch  
Tel. +7 996 730 0113  
d.kosuch@vm-verlag.com

## ADVERTISING SALES

Martina Lerner  
Tel.+49 6226 971515  
lerner-media@t-online.de

Bella Eidlin  
Tel. +49 152 29907895  
b.eidlin@vm-verlag.com

Olga Kirchner  
Tel. +49 152 05626122  
o.kirchner@vm-verlag.com

## ADMINISTRATION

Alla Kravets  
Tel. +49 2233 949 8793  
a.kravets@vm-verlag.com

## PRINTING

maincontor GmbH  
Dr.-Gammert-Str. 13a, 63906 Erlenbach, Germany  
T.: +49 937294810811  
www.maincontor.de, info@frankhohmann.com

## SALES REPRESENTATIVES

Quaini Pubblicita (Milano IT)  
Tel. +39 02 39216180  
info@quaini-pubblicita.it

China & Asia  
octavia@ringier.com.hk, Tel. +852-9648-2561  
maggieliu@ringiertrade.com, Tel. +86-13602785446

Tokyo PR Inc. (Japan)  
Tel. +81 (3) 3273-2731  
extrusion@tokyopr.co.jp

## Reprints, Translation etc

No part of this publication may be reproduced, stored in a retrieval system, or transmitted, in any form or by any means, electronic, mechanical, photographic, recording or otherwise, without prior permission of the publisher.

[www.smart-extrusion.com](http://www.smart-extrusion.com)



motan®   
colortronic®

## Perfect and constant dosing

 think materials management



Live at the „K-Show“:  
19-26 October 2022,  
Hall 10, Stand D02/D04



## SPECTROPLUS

A dosing unit for all extrusion- and compounding tasks.

motan-colortronic gmbh - [info@motan-colortronic.de](mailto:info@motan-colortronic.de)  
[www.motan-colortronic.com](http://www.motan-colortronic.com)



### 3RD EAST AFRICA INTERNATIONAL PPPEXPO AFRICA TANZANIA 2022

(Plastic, Printing and Packaging  
Exhibition)

22. – 24. 09. 2022

Dar-es-Salaam, Tanzania

[www.expogr.com/tanzania/pppexpo/](http://www.expogr.com/tanzania/pppexpo/)

### COLOMBIPLAST

26. - 30. 09. 2022

Bogotá, Colombia

[www.eng.colombiaplast.org](http://www.eng.colombiaplast.org)

### Chemical Recycling Europe Annual Conference (CRE)

13. - 14. 10. 2022

Brussels, Belgium

[www.chemicalrecyclingeurope.eu](http://www.chemicalrecyclingeurope.eu)

### 4TH EAST AFRICA INTERNATIONAL PPPEXPO AFRICA ETHIOPIA 2022

(Plastic, Printing and Packaging  
Exhibition)

18. – 20. 10. 2022

Addis Ababa, Ethiopia

[www.expogr.com/ethiopia/pppexpo/](http://www.expogr.com/ethiopia/pppexpo/)

### K 2022

19. – 26. 10. 2022

Düsseldorf, Germany

[www.k-online.com](http://www.k-online.com)

### wire South America TUBOTECH

25. - 27. 10. 2022

[www.wire-south-america.com](http://www.wire-south-america.com)

[www.tubotech-online.com](http://www.tubotech-online.com)

### INDIA ESSEN WELDING & CUTTING 2021

23. - 25. 11. 2022

Bombay, India

[www.india-essen-welding-cutting.com](http://www.india-essen-welding-cutting.com)

### Plast Eurasia

23. – 26. 11. 2022

Istanbul, Turkey

[www.plasteurasia.com](http://www.plasteurasia.com)

### interpack 2023

04. - 10. 05. 2023

Düsseldorf, Germany

[www.interpack.de](http://www.interpack.de)

## The Halls are Packed: This is interpack 2023



■ From May 4 to 10 2023, Düsseldorf will once again become a business platform and future technology workshop. interpack has already been fully booked out.

18 halls, targeted exhibition areas, new speciality shows and forums demonstrate the industry's innovative prowess. Around 2,700 exhibitors from around the world will present leading technology and packaging trends from the entire value chain. Six years and a forced absence during the pandemic mean that there is a multitude of novel developments on the market.

Although there is still a year before the event, interpack has already been fully booked out and will occupy the entire exhibition area. Interested companies can still register for the waiting list and thus have the chance to exhibit too.

interpack demonstrates the influence that megatrends like connectivity, security and sustainability have on the future of the continuously evolving packaging industry. "Conditions like scarcity of resources and disrupted supply chains pose great challenges to the industry, while simultaneously factors such as increasing demand, new technology and a growing awareness of sustainability offer us big chances to take huge strides forward," says Thomas Dohse, Project Director for interpack. "interpack is the place where the industry creates the future at a global level".



(Photos: Messe Düsseldorf,  
Constanze Tillmann)

interpack delivers stimuli for progressive and visionary concepts, and continues to expand the accompanying programme accordingly. At the moment, there are plans for several speciality shows and forums. For example, specially themed days ensure that visitors receive targeted information. interpack uses this to demonstrate answers to current challenges within the packaging industry. Next year's event will specifically focus on the topics of circular economy, saving resources, digital technology and product safety.

Outside exhibition times, too, interpack's digital communication platform Tightly Packed keeps its finger on the pulse and continues to offer information on new developments, best practices and trends.

➔ Messe Düsseldorf GmbH  
[www.interpack.de](http://www.interpack.de)



## wire and Tube 2022 – Sustainability a Much-Debated Topic in the Exhibition Halls

■ Economically challenging times and geopolitical crises on the one hand, and the longing for personal encounters and expert conversations, on the other – against the backdrop of this global climate the world's leading trade fairs for the wire, cable and tube and pipe industries, wire and Tube, have closed their doors after five successful trade fair days in Düsseldorf. 1,822 exhibitors from over 50 countries came to Düsseldorf from 20 to 24 June 2022 to present technology highlights from their industries on 93,000 square metres of exhibition space.

“Düsseldorf is and will remain the place to be for these weighty industries. Especially in times of sustainable change it is more important than ever to be represented here in Düsseldorf and in direct exchange with the players in these industries,” stressed Bernd Jablonowski, Executive Director at Messe Düsseldorf, and went on to say: “Düsseldorf has paid off again – was the feedback from the well-attended exhibition halls. Most companies plan to return again in 2024.”

“In-depth conversations about the current challenges associated with

the global energy transition, new requirements made on machines and equipment – and all of this considering sustainability aspects – the need for discussion among exhibitors and visitors in the exhibition halls was enormous,” confirmed Daniel Ryfisch, Project Director of wire/Tube and Flow Technologies commenting on the successful re-start of the trade fairs.

This was the first time for the players in the wire, cable, pipe and tube industries to join Messe Düsseldorf's ecoMetals Campaign. A transformation of these energy-intensive industries towards more sustainability has already been actively supported by Messe Düsseldorf for years now. Because the ecoMetal-trails demonstrated live that the exhibitors at wire and Tube are not only innovative but are also increasingly producing in an energy-efficient and resource-saving way.

wire 2022 presented 1,057 exhibitors from 51 countries on some 53,000 square metres of net exhibition space showcasing wire making and wire processing machines, wire, cable, wire products and manufacturing technology, fasteners and spring making technology including finished products and grid-welding machinery. In

addition to this, innovations from the measuring, control technology and test engineering were on display.

On over 40,000 square metres of net exhibition space with 765 exhibitors from 44 countries the international tube and pipe trade fair Tube showcased the complete bandwidth from tube manufacturing and finishing to pipe and tube accessories, tube trading, forming technology and machinery and plant facilities. Process technology tools, auxiliaries and measuring and control technology as well as test engineering also rounded off the ranges here.

With strong contingents at wire and Tube were exhibitors from Italy, Turkey, Spain, Belgium, France, Austria, the Netherlands, Switzerland, Great Britain, Sweden, Poland, the Czech Republic and Germany. From overseas, companies from the USA, Canada, South Korea, Taiwan, India and Japan travelled to Düsseldorf.

2024 will see wire and Tube held concurrently again from 15 to 19 April at Düsseldorf Exhibition Centre.

➔ Messe Düsseldorf GmbH  
[www.wire.de](http://www.wire.de), [www.Tube.de](http://www.Tube.de)

## SPE Thermoforming Division announced 2023 Conference



■ The Society of Plastics Engineers (SPE) Thermoforming Division announced it will be holding its 29th biennial SPE Thermoforming Conference October 24-26, 2023 in Cleveland, Ohio.

“We at SPE Thermoforming Division are very excited to be hosting our 2023 conference in Cleveland,” said Steve Zamprelli, SPE Thermoforming Division Chair. “After careful consideration, we chose Cleveland for many

good reasons. It is centrally located and within easy driving distance to many thermoformers and plastics industry suppliers. In addition, the Huntington Convention Center is an excellent facility with plenty of room for equipment. We look forward to welcoming the thermoforming community to Cleveland in October 2023.”

The 2023 conference, with a theme of ‘The Business of Thermoforming’, will be a 3-day event and is expected to draw a large number of exhibitors.

Booth space and sponsorship opportunities for the 2023 conference will begin later this year, and registration details will be posted to the SPE Thermoforming Division's website,

➔ THE SPE THERMOFORMING DIVISION  
<https://thermoformingdivision.com>

## PLASTPOL 2022

■ PLASTPOL Expo is Central Europe's leader in the sector of plastics processing industry events. The trade fair hosted almost 400 companies from 26 countries worldwide, which used almost 10 thousand sq.m. as the exhibition space.

This year's PLASTPOL - International Fair of Plastics and Rubber Processing proved to be an important enabler for new supply and sales chains within the plastics processing sector. This exhibition has been confirmed by a successful visit of Qatar and Angola representatives. They were looking for new investors at the Kielce exhibition and congress centre. Foreign missions were prospering for companies from Poland but also from other European countries.

This year's edition is marked by a strong presence of companies and institutions representing critical economic centres; for 26 years, German, Austrian and Swiss companies have perceived PLASTPOL as the place to prosper for important customers, new markets and key business contacts. Targi Kielce hosted, to name a few, ENGEL, ARBURG, KRAUSS-MAFFEI, BATTENFELD- WITTMANN, EREMA, MEUSBURGER and EVONIK INDUSTRIES, to name just a few firms. Italy also enjoyed a strong representation; the expo halls were the showcase for MORETTO, MEPOL, CONFINDUSTRIA POLONIA and AMBRA POLYMERS. The potential of Polish processing



trade show is also recognised by global institutions; both the Embassy of Angola and Qatar Development Bank together with Qatar Financial Centre joined the expo to present their economic potential. Not only did they exhibit at Plastpol, but also organised a series of meetings devoted to investment opportunities as well as these countries' production industries' development prospects.

The industry finds recycling important: As every year, recycling and the activities targeted at producers, institutions, and consumers in particular, were discussed at the conference "Plastics recycling - one goal, many possibilities" held within the scope of the PLASTPOL Expo held in Targi

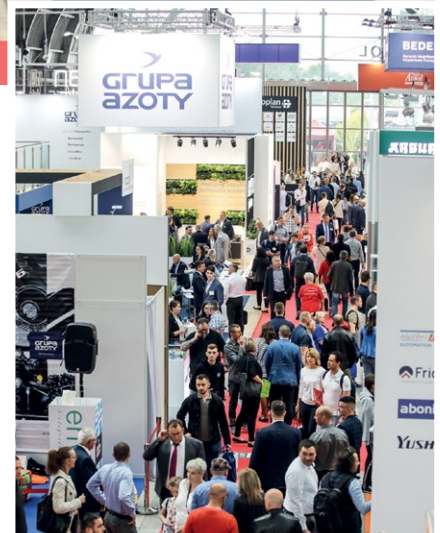

Kielce. The meeting was organised by the Waste Management and Recycling Cluster- National Key Cluster.

One of the conference topics was the use of platforms to track the raw materials circulation and recirculation on the example of the RecoTrace platform.

The meeting brought together experts in plastics processing and plastics recycling associated with at the PlasticsEurope Polska Foundation, including Anna Kozera-Szałkowska, Managing Director of Plastics Europe Polska, Andrzej Kubik from GPR GUMA and Plastik Recycling, and Kazimierz Borkowski from Ambiente.

The 27th edition of the Targi Kielce's International Fair of Plastics and Rubber Processing PLASTPOL will take place from 23 to 26 May 2023.





# Supply of Slitter Rewinders and Outlook for Additional Lines Thanks to Relationship with Chinese BOPP Film Giant



■ Fujian Forop Advanced Materials is one of the top three leading companies in the Chinese market for the production and sale of BOPP film products. The Chinese industrial giant means to start-up two new production sites in southwest and southeast China by 2025, leading to a total of six production sites with 30 BOPP production lines. This huge industrial development will serve to boost the production potential of the group, which intends to become the largest producer of BOPP film in the world.

The agreements signed in 2021 for the supply of 16 GOEBEL IMS MONOSLIT 9000 BOPP slitter rewinders create the solid basis for a great partnership, in which IMS TECHNOLOGIES supports the Chinese manufacturer in its ambitious industrial plan. A further agreement is expected to be finalized in 2022 that will bring additional primary slitter rewinders for another 6 BOPP production lines, already ordered by Forop Advanced Materials at the beginning of 2022.

The business relationship with the Chinese group is based on the shared values of profession, reliability, cooperation and innovation: IMS TECHNOLOGIES technology is part of a smart manufacturing plan aimed at the production of innovative technical products able to increase the Forop Advanced Materials competitiveness on international markets.

Tobias Lankswert, Managing Director of GOEBEL Schneid- und Wickelsysteme GmbH and Sales Director Film adds: "Such a project is unique in our history, we are very proud and thankful that FOROP put its trust in GOEBEL IMS. With this project we show once more that we are the world market leader if it comes to primary slitting and rewinding, especially in the field of high-speed BOPP converting. We are looking forward to a long and fruitful cooperation with FOROP."

► IMS TECHNOLOGIES Spa  
[www.imstechnologies.com](http://www.imstechnologies.com)

Fujian Forop Advanced Materials Co. Ltd.  
<https://ffjfurong.en.alibaba.com/>

hoch5.com

## CCA

The Original

### Quality is our Priority

Backed by 30 years of experience, CCA develops calibration sleeves for plastic pipe extrusion:

- from Ø 12mm up to Ø 2.400mm pipe outside diameter
- precisely matched to the production requirements of our international customers

**Rely on quality „Made in Germany“.**

[www.ccagmbh.de](http://www.ccagmbh.de)

**We look forward to meeting you!**  
 Hall 10, Booth F 34

## Over 20 Thousand Visitors at the First Edition of Greenplast

■ Greenplast, the trade fair organized by Promaplast and staged in its first edition at Fiera Milano Rho-Pero from the 3rd to the 6th of May 2022 was a resounding success. In 6,000 square metres of net exhibition space, the fair hosted 170 exhibitors who showcased the most advanced solutions in terms of materials, production processes, machinery, and services for a more sustainable plastics and rubber industry working toward a circular economy. The first edition was attended by over 20,000 visitors from 55 countries, greatly exceeding expectations, and by highly qualified buyers, who were quite interested in the innovations presented at the fair.

The exhibitors expressed their enormous satisfaction, positively impressed by the sensitivity and awareness of operators regarding the focus themes offered by the fair, which represent the present and the future of the plastics and rubber industry.

The exhibition was also enriched in terms of content, hosting several events from the third edition of Packaging Speaks Green, the international forum dedicated to



the development of the culture of sustainability and circular economy in the plastics and packaging industries. Over 400 operators took part in the various sessions of the event: pharma, beauty & chemicals, plastics and recycling, save food, food & beverage. The event was sponsored by Amaplast and Ucima, associations representing Italian manufacturers of plastics and rubber processing machinery and of packaging machinery, respectively.

Greenplast took place in conjunction with three other leading in industrial machinery engineering fairs making up the network The Innovation Alliance: Ipack-Ima, Print4All, and Intralogistica Italia. Together, the four events attracted over 90,000 professional operators, who were given a privileged view of an exhaus-

sive overview of technology relating to the industry. The success convinced the organizers of the four fairs to plan the next edition from the 27th to the 30th of May 2025.

In the meantime, the organizational machinery of Plast, the long-running international event for the plastics and rubber industry organized by Promaplast, is already in motion: after the forced interruption caused by the pandemic, the 19th edition will take place in Milan from the 5th to the 8th of September 2023. Over 30,000 square metres of exhibition space have already been confirmed by the exhibitors who want to guarantee their participation in Plast 2023.

➔ [www.greenplast.org/en/](http://www.greenplast.org/en/)  
 ➔ [www.plastonline.org/en/](http://www.plastonline.org/en/)

## AMAPLAST Assembly

■ The annual member assembly of Amaplast – national trade association, member of Confindustria, that unites some 170 Italian manufacturers of machinery, equipment, and moulds for plastics and rubber – took place on 7 July 2022. The assembly included a voting session which elected the 9 members of the Board of Directors for the two-year term 2022 to 2024:

- Alessandro Balzanelli (F.B. BALZANELLI)
- Michele Bandera (COSTRUZIONI MECCANICHE LUIGI BANDERA)
- Gianfranco Cattapan (PLASTIC SYSTEMS)
- Maria Grazia Colombo (BFM)
- Giovanna Franceschetti (GEFRAN)
- Gianni Luoni (ELBA)



- Fabiola Plebani (MAST)
- Barbara Ulcelli (IMG)
- Corrado Zanga (UNILOY ITALIA).

In his address, President Dario Previero illustrated the performance of the Italian industry of plastics and rubber processing machinery, commenting on the results of the second edition of the National Statistics Study by the MECS-Amaplast Statistical Study Centre on 400 manufacturers (with 13,900 employees) who generated revenues of over 4 billion euros in 2021, a twelve percent increase over 2020 with a 72% share going to exports.

Previero went on to confirm the effectiveness of synergy with ACIMAC (Association of Italian Manufacturers of Machinery and Equipment for Ceramics) and UCIMA (Italian Packaging Machinery Manufacturers Association), which has made it possible to share and make available a series of increasingly up-to-date and customized services to member companies, supporting them in their day-to-day operations.

#### Sector data:

The second National Statistics Study by the MECS-Amaplast Statistical Study Centre produces a snapshot of some 400 Italian manufacturers of plastics and rubber processing machinery, equipment, and moulds, employing more than 13,900 people and generating revenues of over 4 billion euros in 2021 (+12% over 2020). The average export ratio is 72%, with peaks of 82% for larger companies. And it is the companies in the category with turnover in excess of 50 million euros (less than 5% of the total) that made the greatest contribution to revenues (over 38% of overall revenues for the industry).

As regards geography, most of the companies (approximately 52%) are located in Lombardy, primarily in the

provinces of Varese, Milan, and Brescia. Next in line are the regions of Emilia-Romagna with 15%, Veneto with 13%, and Piedmont with 9%.

As regards the customer categories of machinery manufacturers, packaging is again in first place, representing 41% of the total (27% food and 14% non-food), followed by automotive with 18%, and construction with 10%, just to mention the principal outlet markets. The medical segment also bears mentioning: although it amounts to a relatively small percentage of the total (5%, one point higher than in 2020), it recorded a rather non-surprising 38% increase in revenues for machinery suppliers.

In line with the results of the previous survey, among the macro-categories of machinery, extruders again represented the lion's share of overall production, with 19% of the total. They are followed by auxiliaries with 14%, injection moulding machines at 11%, and moulds/dies for plastic at just under 8%.

The 2021 results are complemented by the indicators for the first quarter of 2022, which describe a continuing positive trend: with respect to the same period in 2021, orders are up by 10%, revenues by 16%, exports by 13%, and imports by 9%. Expectations for the second quarter are also marked by a certain optimism, at least as regards orders, estimated to have increased further by 6-7%. Naturally, various unknowns and issues that follow upon one another and have now been overlapping for months generate no small concern among business owners, who remain cautiously optimistic, expecting the balance to be positive again in 2022, but less brilliant than last year.

➡ **AMAPLAST**  
www.amaplast.org

## Acquisition

■ With the acquisition of the Italian producer Auserpolimeri s.r.l. as of 29 July 2022, Brüggemann underlines the company's ambitious expansion strategy.

"Auserpolimeri's chemically functionalised polyolefin-based polymers play a key role as impact modifiers, compatibilisers, coupling agents and adhesion promoters in improving the performance levels of engineering plastics for a wide range of applications. They ideally complement and complete our existing range of high-performance additives," says Dr. Klaus Bergmann, Head of Polymer Additives at Brüggemann.

Both Brüggemann and Auserpolimeri are established manufacturers with proven expertise and

long-standing international customer relationships and have grown strongly in recent years. Brüggemann Managing Director Dr. Stefan Lätsch emphasises that the Eigenmann & Veronelli Group has not only developed the Auserpolimeri site near Lucca by investing in its facilities and personnel, but also expanded its extensive customer network to a global level.

Auserpolimeri and Brüggemann are united not least by their focus on highly specialised applications in which agility, product knowledge and consulting strength are indispensable success factors, especially in application technology. Dr Stefan Lätsch comments: "We see the commitment to uncompromising quality

assurance and to constant innovation as a significant common denominator. We welcome our new and highly qualified colleagues to our business and are looking forward to further growing our activities together. Customers of both companies will benefit from the close cooperation between sales, R&D, application technology and production – in the future, we will be able to offer customers even more differentiated market and product solutions." Overall, Brüggemann is growing to more than 300 employees and sales of 210 million EUR/year.

➡ **L. Brüggemann GmbH & Co. KG**  
www.brueggemann.com

## European Plastics and Rubber Machinery Industry Fall Shy of Global Production Growth

■ Based on estimates, the global production of plastics and rubber machinery grew by 13% in 2021 and reached a new record level of 38.6 billion euros. China in particular stood out as a driver here, increasing its production by an above-average 15%. European plastics and rubber machinery manufacturers achieved a slightly below-average increase of 11%, and now account for 40% of global production. Although this means they continue to hold the lion's share of global production, the figures also make it clear that the global plastics and rubber machinery sector has undergone a couple of shifts in recent years. In the past, the European share still accounted for almost 45%.

The fact that China exported the most plastics and rubber machinery for the first time last year also fits this picture. The People's Republic increased its exports by an impressive 28.2% to 5.7 billion euros, thus relegating Germany to second place, and resulting in it having to relinquish its title of world export leader, with 5.2 billion euros (plus 9.4%).

"In the medium term, companies in Europe will have to prepare themselves for a significantly higher price level, as raw materials and energy in particular, have become much more expensive. At the same time, the situation in the supplier market is causing

problems, plus, due to the increased uncertainty resulting from the war in Ukraine, processors are holding back on investments and therefore on new orders for machine manufacturers" stated Luciano Anceschi, President of the European umbrella organization of the most important national plastics and rubber machine manufacturers (EUROMAP), summing up the difficult situation.

"We have benefited from Covid, but now we have to brace ourselves for the fact that a saturation effect has occurred in large parts of our customer industries, and further growth will be difficult to achieve this year under the current conditions," Anceschi continues.

The European plastics and rubber machinery manufacturers are looking forward to the K trade fair in October, in order to be able to present the performance of their machines and their technical innovations to their customers, with a view to circular economy and digitalisation.

At K 2022, EUROMAP will demonstrate the OPC UA technology and the specifications for digital interfaces already available for plastics and rubber machinery in action. Live data from connected machines can be accessed via an online dashboard by any trade fair visitor using a smartphone. Machine manufacturers worldwide can

participate. This is aimed at making the great potential of platform-independent and manufacturer-independent machine-to-machine communication both visible and tangible.

Interoperability in production, i.e. the networking of all components within the production line, is considered a prerequisite for Industry 4.0. This gives machine operators the necessary access to production data, which allows them to monitor and control the processes for greater efficiency, traceability, condition monitoring through to machine learning, and artificial intelligence – and that in turn renders decisive competitive advantages for them.

The prerequisite for convenient "plug-and-play" networking is globally recognised, uniform standards for data exchange. The OPC UA standard as a global machine language is the perfect basis for the development of technical specifications for individual machines and components. After being initiated by VDMA and EUROMAP, the development of specifications is now taking place at a global level, together with the OPC Foundation and international partner associations.

### ➔ EUROMAP

c/o VDMA Plastics and Rubber Machinery  
[www.euromap.org](http://www.euromap.org)

## Multifunctional Coating Line

■ Lenzing Plastics and SML are not just linked by their geographical proximity in Upper Austria. The companies have a "genetic relationship" through their common past and common roots. Both were once business units of Lenzing AG. Whereas SML separated from Lenzing AG in 1995, Lenzing Plastics was spun off as a separate company in the year 2000.

Two years ago, Lenzing Plastics decided to invest in a modern multi-functional coating line for technical applications, e.g. for the construction or the automotive industry. Following a tough bidding process, SML was awarded the contract.

The new line, which is being commissioned, is 100 percent tailor-made to Lenzing Plastics' specific requirements.



Jürgen Miethlinger, Managing Director Lenzing Plastics,  
 Karl Stöger Managing Director SML



Despite its product width of up to 3.2m, it establishes new benchmarks in terms of flexibility, operating comfort and digital and functional innovations.

Due to the huge variety of different products Lenzing Plastics manufactures, the latter had high demands concerning the flexibility of different product widths, as well as the type of substrates and applied polymers. Equally demanding were the requirements for very quick setup times between one production run and the next.

To provide an example: The two extruder screws (135mm and 90mm in diameter) can be changed in the shortest time, thanks to a new quick-change-system which SML has developed especially for Lenzing Plastics. Generally, the line can be switched from the production of common polyolefins to special TPU applications in less than three hours.

Thanks to an inline slitting unit featuring multiple knives, Lenzing Plastics can run several part bobbin rolls in finished

widths on one winding shaft. This saves time and money since an additional production step via a slitter rewinder can be avoided.

SML's new SMILE operating interface in combination with the data generation and analysis tool BitWise ensures the comfortable operation of this new coating line. The maximum reproducibility of specific formulations is a solid basis for effective quality control and constant production qualities.

As a result of the close cooperation between the technicians from Lenzing Plastics and SML, both companies were able to benefit and to strengthen their leading position. As a result of the success of this project, there is a mutual commitment to forge ahead with further cooperation in the future.

► SML Maschinengesellschaft mbH  
www.sml.at

# Precision Wall Thickness Measurement



**Zumbach**  
SWISS PRIME MEASURING SINCE 1957

19. - 26. 10. 2022  
Düsseldorf,  
Germany  
Stand: 10E27



## RAYEX S

- Easy and quick set up for new products
- Fast eccentricity and diameter measurement
- Added longevity due to high-quality xray source





Family owned since 1957, Zumbach is a global leader in the industry.  
Driven by innovation and experience.  
We are here for you and ready to build the future together.

[www.zumbach.com](http://www.zumbach.com) • [sales@zumbach.ch](mailto:sales@zumbach.ch)

## New Distribution Partner

■ AKRO-PLASTIC announced that it has selected IMCD Group, a leading distributor of speciality chemicals and ingredients, as its new distribution partner in Europe. The distribution agreement covers all European countries (except for Germany, Turkey, and the Nordic region.)<sup>1</sup>. Distribution agreement took effect on July 1st, 2022.

New agreement applies to all AKRO-PLASTIC compounds known under the trade names AKROMID®, AKROLOY®, PRECITE®, AKROTEK® and AKROLEN®.

Besides strengthening AKRO-PLASTIC and IMCD efforts to offer best in class products and inspiring solutions, this agreement opens new and advanced possibilities to the engineering plastics customers of both companies across Europe. IMCD has a strong presence and long history in the plastics industry, and its broad polymers' portfolio will complement AKRO-PLASTIC's offering.

<sup>1</sup> The distribution agreement covers most of the Europe, with the exception of Germany, Turkey, Norway, Sweden, Finland, Denmark, Estonia, Latvia and Lithuania



▶ AKRO-PLASTIC GmbH  
<https://akro-plastic.com/>

▶ IMCD-Gruppe  
[www.imcdgroup.com](http://www.imcdgroup.com)

## Series of Explosion-Proof Roots Pumps Expanded

■ Roots pumps from Pfeiffer Vacuum's OktaLine are ideal for use in processes in potentially explosive environments or for evacuating explosive gases. Designed in accordance with the ATEX Directive (2014/34/EU1 and/or 1999/92/EC) with pressure surge resistance of PN 16, they meet the very highest explosion protection requirements. Zone entrainment of explosive gases is ruled out as a result. Potential applications range from the chemical, biotechnology and pharmaceutical industries to industrial applications such as vacuum furnaces or heat treatment.

As a result of the expansion of the series, pumping speeds range from 280 to 8,100 m<sup>3</sup>/h. Depending on the

application, there is a choice between equipment category 2G or 3G. All pumps are suitable for temperature class T3. Installation is possible without flame arresters. This means that, effectively, the full pumping speed of the pump is available.

The pumps are suitable for universal use due to their variable differential pressure and flexible rotational speed. All pumps can be used at ambient temperatures ranging from -20 °C to +40 °C.

In view of their magnetic coupling, OktaLine pumps are hermetically sealed and achieve extremely low leak rates of 10<sup>-6</sup> Pa m<sup>3</sup>/s. The magnetic coupling eliminates the need for shaft seals, which are inherently weak points if it comes to pressure surges and are high-maintenance. OktaLine ATEX pumps are pressure surge resistant up to 1600 kPa. Due to their magnetic coupling, there is no risk of zone entrainment. The integrated temperature sensor protects against thermal overload and monitors the gas temperature in the outlet area.

Compared to pumps with shaft seals, the OktaLine's magnetic coupling achieves up to 20% lower operating costs and considerably reduced maintenance costs. OktaLine Roots pumps can also be operated without a bypass, since ATEX protection is guaranteed even with passive rotation (windmilling). The use of ATEX IEC motors means that replacement on site is quick and easy.

*Pfeiffer Vacuum expands the OktaLine ATEX series of explosion-proof Roots pumps*



▶ Pfeiffer Vacuum GmbH  
[www.pfeiffer-vacuum.com](http://www.pfeiffer-vacuum.com)



# BREYER

*extrusion lines*



## High-tech for the sunny side of life. **BREYER CellProtect**

*filmlines*

NEW: Energy saving system · No post-annealing · No interlayer film

### Visions of today – solutions of tomorrow.

The convincing extrusion technology for the production of low shrinkage EVA and POE encapsulant film for PV-modules.



**INNOVATIONS FOR BETTER SOLUTIONS**  
Visit us at K 2022, Düsseldorf, Germany  
19–26 October 2022 · Hall 16 / 16D38

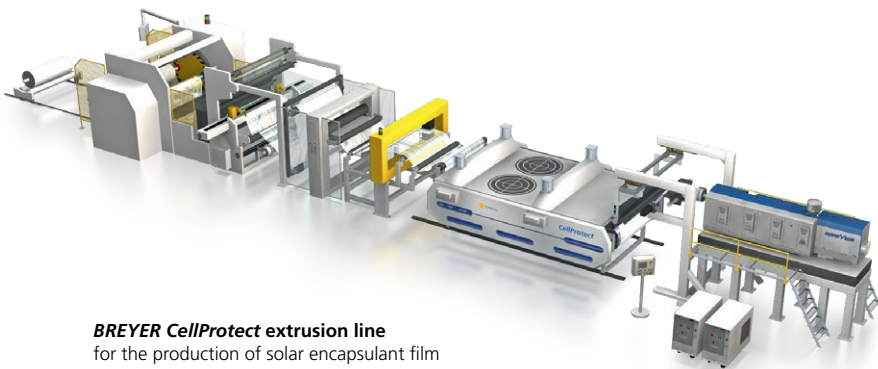

**BREYER CellProtect** extrusion line  
for the production of solar encapsulant film

### **BREYER GmbH Maschinenfabrik**

Georg-Fischer-Str. 40  
D-78224 Singen  
Germany  
Tel. +49 7731 920-0  
info@breyer-extr.com



Please use our website for further information and special requests:

Quality made in Germany · [www.breyer.world](http://www.breyer.world)

## Strategic Start-Up Investment

■ Shortly after port F was founded in January 2021, initial talks began with Biofiber Tech Sweden AB (BFT for short) to evaluate a possible strategic collaboration, including investment options. BFT is a successful greentech start-up that offers innovative solutions in the field of bio-based raw materials for various plastics applications. Due to shared visions and numerous overlaps between the start-up and the operational business areas of the Feddersen Group, the discussions quickly became concrete. In June 2022, the investment contracts were signed on both sides.

"The cooperation with BFT is not just about a pure equity investment, but in particular about the strategic cooperation between BFT and the subsidiaries of K.D. Feddersen Holding GmbH," explains Silke Hamm, responsible for business development at port F, and goes on to explain, "It is a win-win situation for us.

The Feddersen Group provides the start-up with operational support in the areas of sales, production and R&D. In return, we get access to a high-quality bio-based material for technical applications."

port F coordinates the strategic cooperation between BFT and the business areas of the Feddersen Group. Specifically, this includes sales & marketing for FibraQ® and the FibraQ® compounds, toll compounding and R&D projects with the K.D. Feddersen distribution companies, AKRO-PLASTIC and BIO-FED, among others. FibraQ® are chemically modified wood fibres and wood fibre



*From left to right: Eric Zhang (Founder & Managing Director of Biofiber Tech Sweden AB), Volker Scheel (Managing Director of K.D. Feddersen Holding GmbH), Luis Valencia (Material Development and Application Biofiber Tech Sweden AB), Christian Gref (Director port F), Sara Georgsson (Business Development, Sales & Brand Management Biofiber Tech Sweden AB) and Silke Hamm (Business Development port F)*

compounds that provide optimal compatibility with plastics to achieve the best possible properties in technical applications in injection moulding, extrusion, thermoforming and 3D printing. "The Feddersen Group is an excellent fit as a strategic investor, as the operating companies can help scale our business on different levels, says Sara Georgsson Business Development, Sales & Brand Management at BFT, adding "It is the perfect partner for us".

port F was founded in January 2021 to be the Feddersen Group's Corporate Innovation Lab, driving innovation in the circular economy within the group. This is done through collaboration with players along the entire plastics value chain and through strategic cooperation with and in-

vestments in start-ups that have a high degree of overlap with the Feddersen Group's operational fields of activity.

With the internationally active Feddersen Group, port F has a strong backing. The group's core competencies lie in the development, production and distribution of engineering plastics as well as in mechanical engineering and trading in machinery for plastics processing. Engineering services and wholesale and foreign trade in stainless steel, other raw materials and technical products are also important pillars of the corporate group.

port F  
www.portf.net

## Global Footprint expanded with the Construction of a New Production Facility in Austria

■ Extreme Coatings, a leading global supplier of wear-resistant coating solutions for the plastics and rubber industries, has announced the construction of a new manufacturing facility in Austria for the production of high-performance coatings for feedscrews in injection molding and extrusion applications. The company has established a European subsidiary, Extreme Coatings GmbH,

and formed a strategic partnership with a leading Austrian engineering services company to operate the facility. The plant in Gmunden, Austria, is slated to open by October 1.

The increased capacity in Europe will shorten lead times, reduce shipping costs, and establish local supply for Extreme Coatings' growing customer base throughout





Europe, according to Scott Caplan, Executive Vice President, Extreme Coatings. The 15,000-sq-ft Austria plant expands Extreme Coatings' global footprint which includes operations in India, South Korea, and Chile.

"The market demand for our wear-resistant coatings has shown exponential growth in several key application areas for quite some time," said Caplan. "We've expanded our global footprint so we can break the logistical logjam that exists today and ensure stable supply to all key European regions."

Extreme Coatings has established a licensing agreement with Austria's FS Maschinenbau, a family-owned engineering services business, to provide engineering and manufacturing services. Extreme Coatings has transferred technology and know-how to FS Maschinenbau and new equipment has already been installed at the new plant.

"We're thrilled about our partnership with Extreme Coatings and look forward to delivering expert engi-

neering and manufacturing capabilities that will ensure steady supply of product for years to come," said Markus Secklehner, Chief Operating Officer of FS Maschinenbau.

Europe continues to be a growing area for plastics manufacturing with feedscrew coatings playing a pivotal role in optimizing the performance of injection molding and extrusion machinery for production of automotive, household goods, and building products.

Extreme Coatings' thermal spray technology applies wear- and corrosion-resistant CarbideX protective coatings made of tungsten or chromium carbide to virtually any new or repaired feedscrew. The process provides a crack- and porosity-free coating within thicknesses ranging from .004-in to .017-in per side and hardness values over 60HRc. CarbideX Proline formulations deliver like-new performance and at least two to three times longer equipment life.

Extreme Coatings  
[www.extremecoatings.net](http://www.extremecoatings.net)

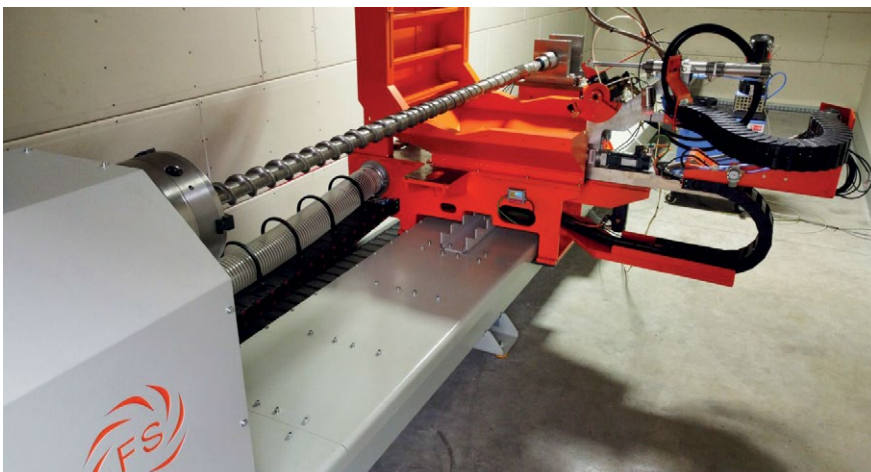

## Flexible electrical heating technology

- Co-Extrusion hoses
- 2K-heated hoses
- Heating plates
- Heating tables
- Heating sleeves
- Spezial solutions



**Hillesheim GmbH**  
Am Haltepunkt 12  
D-68753 Waghäusel • Germany  
Phone: 49 72 54 / 92 56-0  
E-Mail: [info@hillesheim-gmbh.de](mailto:info@hillesheim-gmbh.de)  
[www.hillesheim-gmbh.com](http://www.hillesheim-gmbh.com)

## Chief Procurement Officer Appointed

■ Surface treatment pioneer Vetaphone, has appointed Gustav Hansen as Chief Procurement Officer as part of its strategic growth programme for the 2020s. His role as CPO will be to develop the supply chain and provide greater security for the company's production team and customers alike, while ensuring that the price level remains competitive.

Trained initially as a machinist, Hansen spent time as an AP graduate in production technology before moving into purchasing and management.

➔ Vetaphone A/S  
www.vetaphone.com

*Gustav Hansen has joined Vetaphone as CPO*



## Executive Vice President of the Digital & Service Solutions Division Appointed

■ Klaus Jell took over the global management of KraussMaffei's Digital & Service Solutions (DSS) division as Executive Vice President on 1st August. He will thus also join KraussMaffei's Executive Committee replacing Nadine Despineux who left the company at her own request on July 31st.

"I am very pleased that we have been able to bring Klaus Jell on board for this strategically important position of Executive Vice President of the Digital & Service Solutions Division. Klaus has played a key role in shaping the fortunes of KraussMaffei in responsible positions in recent years. In addition, he is an internationally very experienced manager who enjoys a high reputation in the plastics industry worldwide," comments KraussMaffei's CEO Dr. Michael Ruf.

Commenting on the departure of Nadine Despineux, CEO Dr. Michael Ruf says: "Nadine Despineux has done valuable and pioneering work for KraussMaffei, not only by her global management of our Injection Molding Machinery Sales and the establishment of the Digital & Service Solutions Division but also by professionalizing of our service business. We thank Nadine Despineux for her great commitment and wish her the very best for her future."

➔ KraussMaffei Technologies GmbH  
www.kraussmaffei.com



*Klaus Jell (Photo: KraussMaffei)*

## New Head of Corporate Communications and Marketing

■ Lizette Ruiz Guevara has been made responsible for global corporate communications and marketing at KraussMaffei starting July 1, 2022. She reports to KraussMaffei Group CEO Dr. Michael Ruf.

"We are very pleased that we were able to win Ms. Ruiz Guevara for this position. With her many years of experience and profound knowledge of the industry, she will decisively advance KraussMaffei's positioning both internally and externally," says KraussMaffei CEO Dr. Michael Ruf.

Ruiz Guevara assesses her appointment as Head of Global Corporate Communications and Marketing as follows: "I feel very honored to be responsible for global communications and marketing activities at one of the best-known traditional German companies in the mechanical engineering sector. I am looking forward to actively shaping the new KraussMaffei."

She succeeds Marion Sommerwerck, who left KraussMaffei of her own volition in February 2022.

➔ KraussMaffei  
www.kraussmaffei.com



*Lizette Ruiz Guevara (Photo: KraussMaffei)*



# Plastics Recycling Awards Europe 2022

■ Gneuss, a family-owned company based in Bad Oeynhausen, Germany, has been shortlisted for the Plastics Recycling Awards 2022 in the category of Recycling Machinery Innovation with its unique MRSjump extrusion technology.

The MRSjump is a new extruder which uses the operating principle of the Gneuss MRS technology however with a vastly expanded devolatilising capacity.

Originally aimed at post-consumer PET recycling, the MRSjump extruder offers PET processors not only unparalleled decontamination performance but also the possibility of retaining or even lifting the intrinsic viscosity of the material without the need for any heat treatment of the material, either before or after extrusion.

The phenomenal devolatilisation performance of the MRSjump extruder offers massive advantages for post-consumer polymer recycling generally, especially for recycling polymers such as polyolefins and PS for food contact applications (to FDA and EFSA) where decontamination of the polymer is important. As in the case of PET, due to the decontamination performance of the extruder, additional, energy intensive heat treatment of the material can be avoided.

This performance was made possible by enlarging the MRS multiple screw design. Both the surface area of the polymer melt under vacuum and the area exchange rate have been drastically increased.

As a result, post-consumer polymers can be recycled energy efficiently in one step with the MRSjump extruder to high quality and high value food contact materials.

➔ Gneuss Kunststofftechnik GmbH  
www.gneuss.com

*Extrusion line with Extruder MRSjump with Vacuum unit, Rotary Melt Filter RSFgenius und Online Viscometer VIS*



## Vice President for Canadian Operations Appointed

■ Davis-Standard announced that Mike Brown has been appointed Vice President of Operations – GTA for the company’s Canadian businesses. In his new role, Brown will be responsible for executing the business operating plan, strategy and performance initiatives for Davis-Standard’s Toronto-based subsidiaries.



*Chris Eidt*

“Mike joins Davis-Standard with over 25 years of progressive experience in engineering, product management, and global operating roles with equipment and processing companies,” said Dan Guthrie, Davis-Standard’s Chief Operating Officer. “We look forward to him leading our Brampton Engineering, Deacro, and Gamma companies to reach our strategic growth goals synchronized with the Surpass global operating principles and our Davis-Standard vision statement.”

## Chief Information Officer Appointed

Furthermore Davis-Standard announced that Christian Eidt has been appointed Chief Information Officer. In his new role, Eidt will be an integral part of Davis-Standard’s senior management team, charged with transforming IT capabilities as the company moves toward an increasingly digital and data-enabled industrial environment. He will be responsible for IT strategy, corporate systems, data and analytics, and cyber security.



*Mike Brown*

“Chris brings a high level of strategic IT leadership and digital transformation expertise to our team,” said Giovanni Spitale, Davis-Standard’s Chief Executive Officer. “We look forward to him directing this new area of focus as we take advantage of systems and technology platforms as powerful business enablers.”

➔ Davis-Standard, LLC  
www.davis-standard.com

## Acquisition

■ Effective June 16, 2022, Kubota Corporation acquired all shares in Brabender Technologie and made it a wholly owned subsidiary of Kubota Holdings Europe.

Japan's Kubota Corporation, with its mature technological knowledge, operates in a wide range of business areas. Kubota Corporation's gravimetric feeders are mainly used in production processes for powders and granules in Japan, China, Korea, and the rest of Asia, where they hold a high market share.

Brabender Technologie has become one of the world's largest gravimetric feeding systems companies, with not only enormous technical expertise, but also expertise in handling a variety of materials with many years of experience in different industry-specific applications.

As part of the same group, Kubota and Brabender Technologie will further expand their business in the gravimetric and volumetric feeder market with a targeted manner in the future. Bruno Dautzenberg, Managing Director of Brabender Technologie, explains, "Kubota Corporation's strengths in the Asian market perfectly complement our technology, technical know-how and existing sales and service network in the European and American markets."

➔ **Brabender Technologie GmbH & Co. KG**  
[www.brabender-technologie.com](http://www.brabender-technologie.com)

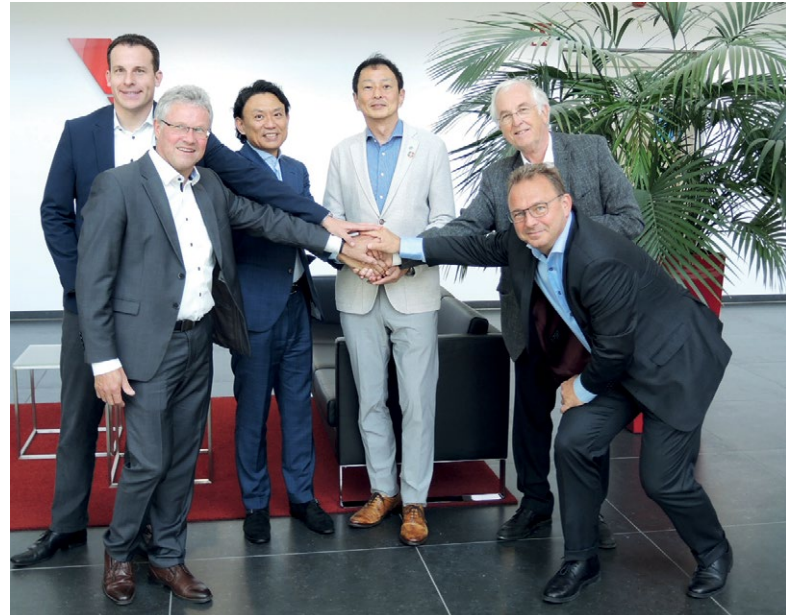

*Meeting between representatives of Kubota Corporation and Brabender Technologie, f.l.t.r.: Jan Pardon (Managing Director Brabender Dienstleistungs GmbH/ Brabender Services), Dr. Günter Kuhlmann (Managing Director Brabender Technologie), Hideki Saiki (Department Manager Precision Equipment Sales Department, Kubota Corporation), Tomohiro Fukihara (Managing Director Precision Equipment Business Unit), Peter Eßer (Managing Director Holzhauser Holding), Bruno Dautzenberg (Managing Director Brabender Technologie)*

## Stake in Start-Up Company

■ As of 30 May 2022, EREMA Group acquired 19.8 % of plasticpreneur® gmbh. plasticpreneur® is an Austrian start-up company founded two years ago that manufactures at its production site in Klagenfurt recycling solutions for plastic waste that are mobile and can be operated without prior knowledge. The machine portfolio covers the recycling process and the production of new end-products. Due to its wide range of applications, it is in demand both in the Global South and in industrialised countries.

In the two years since the company was founded, plasticpreneur® has already sold 330 machines to customers in over 70 countries on all continents. In addition, they have made over 750 application-specific moulds, many of them custom-built to comply with individual customer specifications. An achievement that impressed Manfred Hackl, CEO EREMA Group, from the moment he first met them: "The young founders and their dedicated



*From the left: Florian Mikl (CTO), Raphaela Egger (Design Lead), Boris Rauter (R&D Machines and Moulds), Sören Lex (CEO) (Photo: plasticpreneur®)*

team exude pioneering spirit, want to shape the future with their work and put their heart and soul into the circular economy and plastics recycling.

Just like we do in the EREMA Group!"

While plastics recycling has gained enormous momentum in the indus-





An examples of application for plasticpreneur® machines: from plastic recycling to the new end product in Uganda (Photo: plasticpreneur®)

trialised countries, more remote and poorer regions of the world have hardly benefited from high-tech solutions for industrial recycling processes so far. They are held back by a lack of infrastructure and know-how. That is why waste is often incinerated or disposed of in landfills, rivers and the surrounding environment. "Our mission – Another life for plastic, because we care – is also aimed at supporting these regions with solutions for plastic recycling, and with plasticpreneur® we have found the ideal partner for this," says Hackl.

The start-up company's machines can process HDPE, PP, PS, LDPE, PLA, AB and TPU separately. Their product range includes a shredder, injection moulding unit, extruder unit for the production of end products, air filters as well as custom-built moulds. "For our machines to be used in regions with little infrastructure, they must be easy to operate without prior knowledge. The fact that we also develop end-product solutions needed locally makes our range of services particularly attractive here," explains Sören Lex, CEO and co-founder of plasticpreneur®. As soon as recycling also becomes a source of income for the operators, they become entrepreneurs. That explains the name of the start-up, a word created from "plastic" and "entrepreneur". plasticpreneur® customers in these countries include e.g. social enterprises and operators of refugee camps, where everyday consumer goods – from clothes pegs and school supplies to toys and fence posts – are produced and sold using plastic waste. This means that the added value stays local.

The demand for plasticpreneur® machines is also increasing in industrialised countries. On the one hand by educational institutions and organisations that use them to raise awareness of the need for a circular economy in workshops and to give pupils as well as adults a better understanding of plastic recycling.



# BEIERS

## INVITATION

Düsseldorf 19-26 OCT

# Hall ▶ 8B/C11-4

# PIPE EXTRUSION LINE

BE BEIER, BE GREENER



16-2800mm PE

16-160mm PP PPR

16-1000mm PVC

110-630mm O-PVC

HIGH EFFICIENCY - LARGE DIAMETER - ENERGY SAVING  
EXTRUSION TECHNOLOGY



80-800mm RTP-Reinforced Thermoplastic Extrusion

[info@beierpm.com](mailto:info@beierpm.com)  
[www.beierextrusion.com](http://www.beierextrusion.com)



## New CEO

■ On August 1, 2022, Next Generation Recyclingmaschinen (NGR) saw a personnel change at the top management. Gerhard Ohler took over the role as CEO of Next Generation Recyclingmaschinen GmbH, based in Feldkirchen/Austria, succeeding Wolfgang Steinwender, who has held this position since May 2020. Ohler has many years of international experience in extrusion technology and plastics recycling.

Josef Hochreiter, CEO of Next Generation Group: "I am delighted to have gained an experienced manager for us in Gerhard Ohler. With this appointment, we will not only be able to successfully continue along the path we have chosen, but also to break new ground in plastics recycling. We have now created the best conditions to realize our mission "working for a better future" together with a highly motivated team and to continue to develop and build highly efficient recycling machines for our customers in the future.

➔ Next Generation Recyclingmaschinen GmbH  
www.ngr-world.com



Gerhard Ohler (Photo: NGR)

## New 800 Series Hybrid Extrusion Tooling Announced

■ Davis-Standard announced the U.S. paGuill announced the introduction of a new version of its popular 800 series, known as 800 Series Hybrid. In some extrusion applications that utilize crossheads and inlines, layers of the exact same material are applied multiple times, using a single die. This method is used to reduce the propensity for errors caused by gels breaking through a thin wall, weld lines, inconsistent wall thickness, plus material and

process variations. Additional errors include difficult-to-process materials and demanding applications where there is zero fault tolerance.

Seeking to design the next generation multi-layer die to overcome these challenges, the engineers at Guill looked for a way to incorporate this technology into an updated version of the 800 Series. This led to the creation of the 800 Series Hybrid. The inherent benefits of the 800 Series are retained, including compact design, low residence time and a common deflector bore that eliminates tolerance stack up. The challenge was to create a hybrid design that incorporates the benefits of layer overlapping, while reducing unnecessary complexity and making the technology more cost-affordable for customers. This was achieved by overlapping layers in each semi-deflector, using a single cone. The highly efficient design of the 800 Series Hybrid reduces cost and size, as opposed to other methods of overlapping layers.

Essential benefits of the 800 Series Hybrid include eliminat-

ing weld lines in materials through patented overlapping technology, producing a more consistent finished product; reduced sensitivity to changes in viscosity; reduced sensitivity to changes in line speed; myriad material and multi-layer application possibilities; works in all tubing and jacketing applications with a wide range of materials; low residence time; compact design and a low tolerance stack-up error factor, all resulting in improved concentricity.

The 800 Series Hybrid extrusion tool greatly reduces stagnation, because overlapping layers are more inherently balanced than single layers and also because each semi-deflector is "tuned to flush." Conventional deflectors must simultaneously achieve a balance between flushing, balancing and eliminating the weld line. There is less difference between the slowest moving material and the fastest moving material in the deflector channels, thus making the viscosity more consistent in the deflector.



➔ Guill Tool & Engineering  
www.guill.com



## New Board Elected

■ European Bioplastics (EUBP), the association representing the interests of the bioplastics industry in Europe, has elected a new Board. The EUBP leadership team will be headed by its new Chairperson, Stefan Barot (BIOTEC) and supported by the new Vice Chairpersons, Lars Börger (Neste) and Mariagiovanna Vetere (NatureWorks). “Never before has our industry received that much of attention. Economically and politically, these are pivotal times, and I’m very pleased to be able to support our industry in my new role as EUBP Chair”, says Stefan Barot. “Crucial EU legislation on bioplastics is expected to be adopted by the end of the year and beyond. This is a great opportunity to fully acknowledge the role of bio-based and compostable plastics within the circular economy. We welcome the European Commission’s initiatives to establish a clear and reliable political environment for bioplastics. This is crucial to ensure a continued successful development of our industry. It also enables bioplastics to contribute



The new Board of European Bioplastics (from left to right): Erwin Lepoudre (Kaneka), Franz Kraus (Novamont), Afsaneh Nabifar (BASF SE), Lars Börger (Neste), Stefan Barot (BIOTEC), Paolo La Scola (Novamont) and (sitting): Peter von den Kerkhoff (Covation Biomaterials LLC), Mariagiovanna Vetere (NatureWorks), and Patrick Zimmermann (FKuR, not on the picture) (© European Bioplastics)

to the achievement of the EU’s ambitious climate goals, especially a lower environmental footprint”, he adds.

Afsaneh Nabifar (BASF SE), Peter von den Kerkhoff (Covation Biomaterials LLC), Patrick Zimmermann (FKuR), Franz Kraus (Novamont), Paolo La Scola

(TotalEnergies Corbion), and Erwin Lepoudre (Kaneka) are also members of the new Board, with the latter serving as the Treasurer.

► European Bioplastics  
www.european-bioplastics.org

## Market Study – Fillers

■ Without stones, there’s no energy transition: mineral fillers help make cars lighter, bioplastics more durable, and wind turbines and solar plants more weatherproof. Insoluble additives make many materials, especially engineering plastics, cheaper and suitable for a use in demanding applications. Ceresana has analyzed the filler industry for the sixth time already. The market researchers expect the global filler market to grow at an average annual rate of 4.8%: Demand for natural calcium carbonate (GCC), precipitated calcium carbonate (PCC), kaolin, talc, wollastonite, mica, carbon black and other fillers is expected to reach a volume of more than 80 million tonnes by 2030.

The study in brief:

Chapter 1 provides a description and analysis of the global filler market - including forecasts up to 2030: demand and revenues of fillers are outlined for each region of the world.

Chapter 2 analyzes revenues and demand of fillers for the 16 largest national markets. Demand is broken down into individual applications and product types; the demand of the specific product types is also examined per application area.

Chapter 3 provides useful company profiles of the most important filler manufacturers, arranged according to contact details, financial data, product range, production sites, brief profile and product types. Detailed profiles are provided by 113 manufacturers.

► www.ceresana.com/en/market-studies/chemicals/fillers/

**From the Simple to the Sublime**

**Series 800 crosshead for two to six layers**

The latest generation of the **Series 800 crosshead** is designed to run two to six layer extrusions for high quality, high accuracy 1/8" to 6" OD tubing for medical, automotive, appliance and industrial applications.

Ideal for fluoropolymer multi-lumen, multi-layer tubing for fuel lines or thin layer combinations of polymers and adhesives to 0.02mm or less.

Features patented **Guill Feather Touch®** concentricity adjustment to eliminate leaking.

Please visit [www.guill.com](http://www.guill.com)

10 Pike Street  
West Warwick, RI 02893  
USA  
sales@guill.com Attention: Bill Conley

## Major Investment in Europe's Capacitor Film Production

■ The currently discussed topics power supply, energy transition, renewable and alternative energies, electric mobility and charging infrastructure, industry 4.0 with automatization and digitalization come along with a growing demand for high performance capacitors. Terichem Tervakoski, a.s. is now responding to this with a significant increase of their production capacities. With the investment in a Brückner LISIM line (Linear Motor Simultaneous Stretching) the company will meet the emerging needs for high-end film applications in the field of ultra-thin and ultra-high temperature electronic capacitors. The line will be the first of its kind in the Western Hemisphere.

Ilkka Penttilä, CEO of Terichem Tervakoski, a.s. says: "Starting in 2025, our significantly increased production capacity will accelerate the green transition as more capacitors are constantly needed to replace old technologies with new



Contract signing: Ilkka Penttilä und Peter Meters

CO2-reducing solutions. The new simultaneous technology will also provide the most suitable process for our latest invention, ultra-high temperature film."

Peter Mertes, Head of Sales Europe, CIS, Maghreb at Brückner Maschinenbau, adds: "This investment will enable our customer to respond to the ever-increasing demand for new high-performance capacitors. The new line is also a logical extension of their current production capacities with an existing Brückner sequential line. We are really proud of this long-standing and innovative partnership with Tervakoski Films Group."

Brückner Maschinenbau GmbH & Co.KG  
www.brueckner.com

## Advanced Web Transfer Device Patented

■ Davis-Standard announced the U.S. patent for a new web transfer device that eliminates waste while simplifying web transfers. This unique design reflects the collaborative efforts of Michael Hitsman, Brian Ouderkirk and Lawrence Fraser. It is available on Davis-Standard multiple turret winders used in continuous web processes where the web delivery and core transfer assembly have one or more core receiving structures.

"Zero speed transfers are challenging due to many types of sensitive webs run on this type of line," explained Lawrence Fraser, Senior Mechanical Project Engineer. "The new device grips the tail of the old roll and the tail of the new, while cutting the web, pasting it, and ironing it onto the prepared core. Essentially,

we've used a bump-paste concept to improve the web cutting and transferring process from a full core to a new core. Not only does this design reduce expensive material waste, but it produces uniform leading and trailing edges to improve web quality."

The transfer device features a web transfer assembly configured to receive a web from the web delivery assembly while also communicating with the core transfer assembly. The web transfer assembly includes a frame and lay-on roll as well as a vacuum hood, each adjustable relative to the frame. The vacuum hood has a cutting device mounted inside with one or more force-holding surfaces configured to releasably hold a portion of the web. These surfaces move relative to the frame and core receiving structures while making contact

with the core receiving structures to transfer the web. The versatility of this device makes it possible for processors to manage webs consisting of paper, paperboard and non-paper products, such as film and polyethylene.

"Creativity and innovation are at the heart of Davis-Standard's business endeavors and a lifeblood of our organization," said Richard Pastor, Vice President of Operations for Davis-Standard's N.Y. facility. "This patent is a visible and tangible representation of how we continually seek solutions that improve customer processes and profitability. I would like to congratulate our team on this achievement."

Davis-Standard, LLC  
www.davis-standard.com



## Rotary Extrusion Dies with 2X Increase in Speed

■ Guill Tool announces a new design for its high-production rotary models, both inline and crosshead style. A 2X increase in speed, with models running to 1000 RPM depending on the application, are now available in the Guill line of patented rotating tip & die designs. By rotating the tooling in relation to the material flow, a rotary head increases the wall strength of an extrusion, thereby allowing a thinner wall with less material and the corresponding cost savings for the user. Typical applications for rotary heads include medical and multi-lumen tubing plus various high-end extrusions with interlocking layer or multiple striping requirements.

Features offered on these new rotating extrusion dies include counter-rotating tip & die, co-rotating tip & die, rotating die with conventional tip, rotating tip with conventional die, crosshead or inline, multi-layer, striping, certain profiles and optional quick-change cartridges that minimize cleaning downtime.

By using rotary dies, extruders can realize a cost savings due to the elimination of secondary processes, cosmetic enhancement of the end product with the elimination of weld or parting lines, plus reduction or complete elimination of ovality.

Guill Tool offers its new high-speed rotary models as turnkey packages, complete with die cart, tools and all



Head on cart

accessories for installation and maintenance.

➔ **Guill Tool & Engineering**  
[www.guill.com](http://www.guill.com)

## PET Washing Systems in Demand

■ Herbold Meckesheim is satisfied with its results after IFAT 2022 in Munich. Despite the current economic uncertainties, the special machine builder has recorded a constant number of incoming orders. After many negotiations, the projects are now seen to get reality – almost 60 percent of these projects are located outside Germany. In addition to individual machine solutions, shredding technology and plastcompactors, dryers and, above all, complete plastic washing lines are the main areas of interest. In the case of the latter, film and PET washing systems continue to be in particularly high demand.

Herbold Meckesheim had focused on this with its range of information for the trade fair and placed washing lines in the spotlight. The hot washing for polyole-

fins was one of the product innovations presented at the fair. The common base of the recycling lines is a hydrocyclone stage with high density separation. Due to the controllable hot wash, the resulting recyclate qualities are suitable for its use in the food sector. The plant and machine solutions are tested and further developed in the company's own technical lab, which is available for customer trials.

Messe München counted some 119,000 visitors during the five days of the trade fair – half of them from abroad, from 155 countries. 2984 exhibitors from 59 nations vied for visitors' attention on the 260,000 square meters of exhibition space. The central theme of IFAT 2022 was the circular economy. Accordingly, Herbold Meckesheim had participated largely in the VDMA Plastics Recycling Theme World, which illustrated circular economy and plastics recycling with exhibits, film clips and recyclates at the booth of the Association of German Machine Builders.

The biggest event of the year is still to come: the K 2022 in Düsseldorf. Here, Herbold Meckesheim will be present with their salesman and machines to familiarize partners and prospective customers with its system solutions for automated plants and recycling lines – which, thanks to their modular design, can be quickly and flexibly adapted to customer requirements. In the process, the modern machines for plastics processing will also become tangible in the literal sense of the word at the machine manufacturer's booth B34 in Hall 9.

*Nearly 60 percent of the upcoming projects arranged with Herbold Meckesheim at the trade fair in Munich are located outside Germany (Photo: Herbold Meckesheim)*



➔ **Herbold Meckesheim GmbH**  
[www.herbold.com](http://www.herbold.com)

## "Be A Waste Transformer"

■ This year, Austrian recycling pioneer Lindner is highlighting once more the importance of the Circular Economy. Over its many decades, Lindner has developed, produced and installed countless shredders and system solutions – both mobile and stationary – to efficiently process various waste streams. Now more than ever, the focus is on energy efficiency, productivity and the economically viable transformation of the old into new – and this includes plastics, as well as waste wood recycling, and the production of high-calorific solid recovered fuels. The innovative technology for this is developed in-house, by Lindner's R&D team with its decades of experience, yet Lindner's customers also benefit from its many cooperative research projects. One of these is the lead project, circPLAST-mr, carried out in partnership with universities and other industry leaders to find new solutions for mechanical recycling.

Be A Waste Transformer – is Lindner's call, but also its promise to the entire waste and recycling industry at the IFAT 2022. In recent years, recycling has become increasingly important, both socially and politically. The EU's Green Deal, specifying recycling quotas, and the drive to keep secondary raw materials in the cycle for as long as possible are shaping the waste management industry just as much as the shortage of skilled workers, rising energy costs, and the demand for higher productivity – challenges that Lindner's team faces with enthusiasm. Dedicated to recycling, Lindner not only offers individual but also comprehensive system solutions, which make it possible to separate potential raw materials as efficiently as possible from various waste streams, such as municipal, commercial or industrial waste. At the same time, the non-recyclable material is transformed into another valuable raw material – medium- and high-calorific alternative fuel – in the secondary shredding process and with the additional use of quality monitoring.

A smart concept can transform a company from a waste collector to a recycler, thanks to the many possibilities of waste processing. The more potential raw materials can be extracted from the material flow, the better the economic balance. Especially with regard to the recovered plastics, more and more waste processors are recognising the additional value that can be created. Together with its subsidiary Lindner Washtech, Lindner has been operating successfully in this segment worldwide for many years. The cornerstone for successful plastics recycling is above all the perfect coordination of the four process steps shredding, sorting, washing and drying. In this way, it is possible to install comprehensive plants – to date, more than 200 plastics recycling plants have been put into operation – to recycle various plastics such as PE-LLD films, PE-HD bottles, PP household goods and PET bottles. In addition to numerous international companies, Europe's first independent research centre, the NTC (National Test Centre Circular Plastics), has also chosen Lindner lines.



*Lindner system solution for plastics recycling  
(Pictures, Copyright: Lindner Recyclingtech)*

Under the project management of the Johannes Kepler University (JKU) Linz, eleven scientific and fourteen well-known company partners, most of them market leaders in their segment, including Lindner, are working on how to obtain high-quality recyclates from used plastics. For the first time, experts from all areas of plastics recycling have been brought together to make the best possible use of possible synergies. In total, the research program is divided into seven work packages (WP): Material flow preparation I (collection and pre-sorting), material flow preparation II (shredding, sorting, washing), data management & digitalisation and LCA-oriented process design. Lindner has taken the industrial lead in the material flow processing work package and is sitting at the table there together with Alpla, the world market leader for plastic packaging, in order to be able to sort and clean packaging even better. The latest technological innovations are used here, which are not yet available on the market.

In the research project, different tasks are being investigated, such as what influence the processing quality has on the sorting quality and which technologies are most effective here – single or twin-shaft shredders – and how must the shredder communicate with the sorting unit. These and other questions, from shredding to washing and drying, are being researched in several test series, thus further expanding the knowledge in each of these segments and better coordinating all interfaces. In this way, it should be possible to optimise plastics recycling significantly and also optimally adapt Lindner's solutions to the market and customer needs.

► Lindner-Recyclingtech GmbH  
[www.lindner.com](http://www.lindner.com)





# Inspection and Classification – Effective Evaluation & Distribution of Raw Materials

■ Pellet inspection ensures 100% control during the production or compounding process. Many manufacturers in the field already offer the inspection systems as well as sorting units for the production of polymers. The pioneering inventor Thomas Alva Edison once said: „If there is a way to make something better: Find it!“. That is exactly what OCS have done.

OCS devices and systems not only provide the appropriate image processing system for inspecting such defects, they can also be classified directly on the basis of specific measurement parameters. Product quality begins with the selection of only high-quality raw materials and top-notch production materials. OCS Optical Control Systems has been developing innovative and efficient customer-specific solutions for quality control and assurance for more than 30 years now.

What is the benefit of sorting out contaminated material and how can we use this? Depending on the end product, product mixes can be used, for example, and the scrap can be used efficiently.

What are the advantages of direct online quality control with OCS measuring systems?

- Optimised product mix on the basis of precise results



- Optimisation of system flexibility through remix
- Significant shortening of transition times
- Possibility for direct intervention

However, also the sales team can use this qualified data to actively promote a certain raw material to their customers.

For example, several options are available for data communication. Customer-specific data preparation and transfer as well as remote control (via communication protocol or digital I/O). Easy integration of external devices (e.g. colour measurement), OPC Server Industry 4.0, easy data transfer to CSV. Further interfaces can be implemented on customer request.

*Inspectable contaminations as well as measurable size & shape changes on pellets*

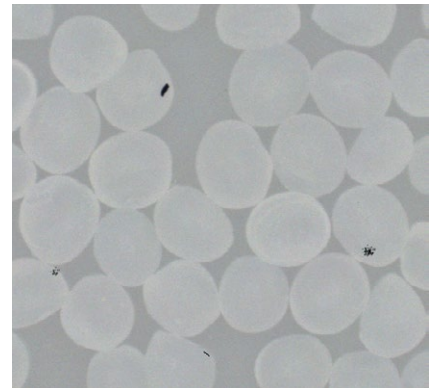

*Optical inspection and measurement by OCS equipment*

➡ OCS Optical Control Systems GmbH  
[www.ocsgmbh.com](http://www.ocsgmbh.com)

*OCS Cast Film Line with extruder and modular film analyser unit for film sample preparation and analysing measurements*



*OCS Pellet Scanner PS25C for pellet inspection and classification of your product*



## Call for Closing the Loop on Plastics and Beyond

■ TOMRA continues to play a key role in closing the loop on PET beverage containers but recognizes that there is more to be done. Now political framework, bold decisions and smart investments in collecting, sorting and recycling should be used to improve circularity across all material streams and to overcome today's supply chain bottlenecks.

"We have an obligation to work with all stakeholders to reduce the mountains of waste and transform them into the valuable resources they are", TOMRA's CEO and President Tove Andersen stated at TOMRA's press conference held at IFAT. Although there has been considerable progress in recycling, the pandemic and the ongoing war in Europe have shown us that there is an urgency to decrease dependency on primary materials. "Today, we invest approximately 10% of our revenues in future-oriented activities to increase resource efficiency, advancing the market for circular solutions, which we are well-positioned to do. We have the technology capable of maximizing collection and recovery rates. We can act now, optimize waste management practices and fill existing gaps", concludes Andersen.

Having established benchmarks for climate policy worldwide, the European Green Deal, coupled with binding regulations and guidelines for producers and manufacturers, drive the acceleration to a circular economy. TOMRA urges all participants in the value chain to see these specifications as an opportunity and to support their implementation. "We have learned that mandatory legislation is necessary in order to achieve goals and create markets," Dr. Volker Rehrmann, EVP and Head of TOMRA Recycling/Mining and Circular Economy, explains. "However, before we can re-



From left: Tove Andersen (CEO and President TOMRA), Dr. Volker Rehrmann (EVP and Head of TOMRA Recycling/Mining and Circular Economy) und Tom Eng (SVP and Head of TOMRA Recycling)

cycle larger volumes we need to collect as much as possible. There are well-functioning collection systems in place, but it is still not enough. Every day we lose valuable resources to landfill and incineration where they are buried and burned. This is low-hanging fruit and the material must be collected, recovered and recycled."

"If we leverage the power of intelligent technologies and closely work with the industry, we can turn waste into value and reduce the dependency on primary materials. Recycling is a key climate mitigator and energy-efficient route to go when supporting a sustainable transition, keeping materials in continuous use. Whatever it takes to close the loop, we will get there", said Tom Eng, SVP and Head of TOMRA Recycling.

► TOMRA Recycling  
www.tomra.com

## Growing Revenues, Plant Sizes and Production Capacities

■ The EREMA Group, which comprises EREMA Group GmbH and its subsidiaries EREMA, PURE LOOP, UMAC, 3S, KEYCYCLE and PLASMACH, closed the 2021/22 financial year with a 17 percent increase in revenue. Consolidated Group revenue amounted to EUR 295 million, and the number of employees increased to over 840. The EREMA Group remains on course for continued growth.



A total of 220 extruders manufactured in Ansfelden were supplied to customers all over the world. If you include individual components and modules such as filter systems and ReFresher anti-odour technology in that figure, the total was around 320. Then there are another 53 extruders from PLASMACH, the Italian subsidiary. The recycled pellet production capacity of all extrusion systems delivered in financial year 2021/22 adds up to around 1.34 million tonnes per year.

A closer look at the post consumer segment clearly shows a trend towards larger plants, both for PET recycling and for processing polyolefins.

Demand for previously-owned machines at UMAC also remained high during the past financial year. In addition to the general trend towards plastics recycling, the decisive factor here is that customers are more frequently opting

*Manfred Hackl, CEO EREMA Group GmbH, sums up the year: "This past financial year, we again set several milestones with growth powered by our technology. We are very proud of this, because the prevailing market conditions were once again very challenging due to corona, cost increases for energy and logistics, and interruptions to the supply chain," is how Manfred Hackl, CEO of EREMA Group GmbH, sums up the year.* (Photo credit: EREMA/Wakolbinger)



for previously-owned systems available at short notice due to the tense situation on the procurement markets. At the same time, businesses that have so far had little contact with recycling are also becoming increasingly interested in this topic. Their need for feasibility studies, consulting and engineering services, project management and turnkey projects are now also very successfully catered for by KEY-CYCLE, an EREMA Group company.

The initiative launched four years ago to modernise and expand existing EREMA Group sites was continued during the past financial year with the expansion and construction of a dedicated machine demonstration centre for PLASMAC in Milan. Equipped with additional production floor space and new and enlarged customer centres, all companies within the group are now well prepared to meet rising demand, and with the new research and development centre under construction in Ansfelden, the framework for further

outstanding plastics recycling milestones from EREMA is currently being optimised.

At K 2022 in Düsseldorf, the EREMA Group companies will be presenting their technological innovations and professional services at a shared stand for the first time this year in Hall 9, Stand C09. Outstanding lighthouse projects that show which solutions have already been implemented together with partners and customers for which plastic waste fractions, and which are currently under development, will be given plenty of space in the outdoor Circonomic Center. There, visitors will also have the opportunity to see recycling processes and the quality of the recycled pellets for themselves during live recycling demonstrations.

► EREMA Group  
www.erema.com

## Extrusion Coating and Laminating Line Installed

■ Popular Aseptic Packaging, one of Pakistan's leading packaging innovators, recently increased capacity with Davis-Standard's German subsidiary ER-WE-PA GmbH's installation of a dsX™ 400 aseptic packaging line. The all-in-one triplex extrusion coating and laminating line will support the company's production growth for a range of food and beverage applications. Popular Aseptic Packaging is known for their single window aseptic packaging for liquids, dairy products and paper cups. This is the company's first machinery purchase from a Davis-Standard company.

"We have been in the aseptic packaging business since 2012 and needed to boost production to address local demand and that of our international customers," said Junaid Malik, managing director of Popular Aseptic Packaging. "It was important for us to have a complete aseptic packaging solution that would provide an edge in terms of increasing quantity without compromising quality and customer satisfaction. Davis-Standard's name continually came up as having the best extrusion coating technology in the industry. After extensive research, customer reviews and detailed discussions, we chose the ER-WE-PA dsX™ 400 aseptic line. Davis-Standard's ER-WE-PA team in Germany did their best to complete the project on time and solve any issues related to equipment or the process, whether remote or in person."

Prior to this installation, Popular Aseptic Packaging had a production capacity of approximately 135 million packs of liquid packaging board per month. Based on increased line speed achieved during acceptance, Popular projects new line will increase that output by up to three times while supporting Popular Aseptic Packaging's strict quality standards and competitive market rates. According to Malik, the line's auto profile control die, online gauge scanner, and trim recycle system have already yielded advantages and cost savings. The die and scanner enable greater product customization, tighter tolerances and consistency for different layers, and the trim recycle system minimizes waste losses while reducing the company's carbon footprint. Currently, the line is

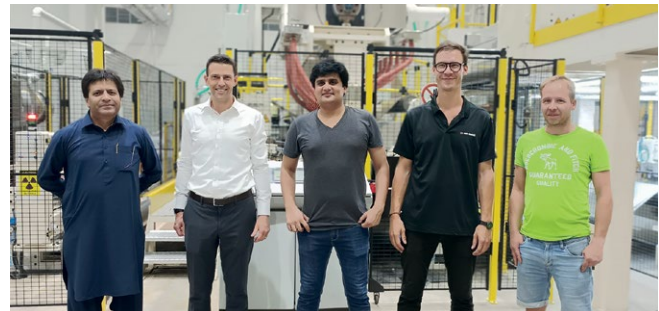

*Pictured from left to right: Syed Ayaz Ali (general manager, Popular Aseptic Packaging), Michael Krämer (managing director, ER-WE-PA GmbH), Muhammad Amin (project manager, Popular Aseptic Packaging), Daniel Schiller (project manager, ER-WE-PA GmbH), Uwe Schulze (commissioning engineer ER-WE-PA GmbH)*

running LDPE, ethylene alpha-olephin, and acid copolymers with plans to further extend the range of resins used.

"The product quality on the ER-WE-PA line has been exceptional along with beneficial features like higher speeds, tighter tolerances, equipment durability and calculated material consumption," added Malik. "We had some obstacles to overcome with pandemic restrictions over the past two years, but Davis-Standard's subsidiary supported us and navigated these challenges to complete the project. We especially appreciate the unconditional assistance and visit to our plant by Michael Krämer, managing director of ER-WE-PA GmbH and his associate, project manager Daniel Schiller. We look forward to ER-WE-PA's continued support with regard to equipment operation, maintenance, spare parts and global supply chain issues."

► Davis-Standard, LLC  
www.davis-standard.com

Popular Aseptic Packaging  
www.populargroup.com.pk

# Global Plastics and Rubber Industry Jointly Active for Climate Protection, Circular Economy and Digitalization

*K in Düsseldorf is the world's most important meeting place for the entire industry.*

*Exhibitors from all over the world come to Düsseldorf to demonstrate the industry's capabilities and actively set the course for the future together with visitors. These clearly lead in the direction of climate protection, the circular economy and digitalization – and these are also the three declared guiding themes of K 2022.*

*The approximately 3,000 exhibitors from 61 countries will occupy the entire Düsseldorf exhibition center.*



October 19 – 26, 2022,  
Düsseldorf, Germany  
[www.k-online.de](http://www.k-online.de)

## K 2022 – Messe Düsseldorf Ensures Highest Air Quality

Messe Düsseldorf is coming up with a new technical highlight: HEPA filters. These high-efficiency particulate air filters introduce clinically clean air into the halls while at the same time reducing heating and cooling energy consumption. Since the end of June 2022, the complete Düsseldorf Exhibition and Congress Centre is equipped with HEPA filters.

It is the most effective air cleaning technology currently available: HEPA filters remove 99.9% of viruses, bacteria and other particulates from the air and release the cleaned air into the room again. These high-efficiency filters make for highest air quality in ORs, at Intensive Care Units and now also at Messe Düsseldorf and Düsseldorf Congress.

Stressing the advantages for the restart, Wolfram N. Diener, President & CEO of Messe Düsseldorf, says: "Our new HEPA filters help to ensure that we can offer all guests the greatest possible protection during our trade fairs. In combination with our high-performance ventilation system, our



(Credit: Messe Düsseldorf/ctillmann)

voluntary hygiene measures, our spacious premises and halls, we reduce the infection risk to a minimum. After two pandemic years and a period of intense digital communication participants can feel safe when network-

ing, initiating business deals and experiencing innovations in person again."

Additional infection protection is not only provided by the HEPA filters and ventilation systems but also by Messe Düsseldorf's voluntary hygiene measures. The trade fair company continues recommending attendees to wear medical face masks and keep a 1.5 m distance from other persons on the fairgrounds. Furthermore, Messe Düsseldorf makes sanitizing dispensers available and has frequently used contact surfaces cleaned several times daily. Distance markings in waiting areas help to prevent crowds from forming in front of information counters and ticket offices. Doors, unless they are fire doors, are left open so that they can be passed through contactless. Transparent droplet guards at service and information counters will also remain in place.

➔ Messe Düsseldorf GmbH  
[www.k-online.de](http://www.k-online.de)



# The Italians at K 2022

There are almost 400 Italian companies in the plastics and rubber sector registered for the upcoming edition of K 2022.

Per tradition, the Italian presence will be second only to that of the host country at the world's most important fair for the sector and will mainly consist of manufacturers of machinery, equipment, auxiliaries, and moulds with over 250 exhibitors in this segment, more than half of them members of the Amaplast trade association.

The Italian companies will offer their numerous professional visitors from all over the world a complete overview of the most advanced Italian-made technology – from primary processing machinery to auxiliary equipment, from recovery and recycling plants to moulds and downstream systems – reflecting Industry 4.0 principles, with solutions for interconnection, energy efficiency, and predictive maintenance.

Amaplast will have an institutional stand at K to support the exhibiting Italian companies, provide a point of reference for the industry, distribute the magazine MacPlas, and promote the nineteenth edition of PLAST (Milan 5-8 September 2023), whose organizational machinery will shift into high gear immediately after the German exhibition. In the meantime, over 30,000 square metres of exhibition space have already been reserved by the more than 600 exhibitors who have already registered.

More than 70% of Italian production of plastics and rubber processing machinery is exported and Germany has been the n. 1 destination market for decades (as well as main partner for imports), both regarding supplies to final customers and supplies of components, auxiliaries, moulds to be integrated into complex systems built by major German brands, demonstrating the respect they have for Italian technology. In 2021, exports to Germany in this sector approached a value of 380 million euros, representing a 13% share on the total and a 10% rise over 2020.

Last year, the entire EU absorbed 45% of Italian exports, followed by North America with 17% and the Far East with 12%.

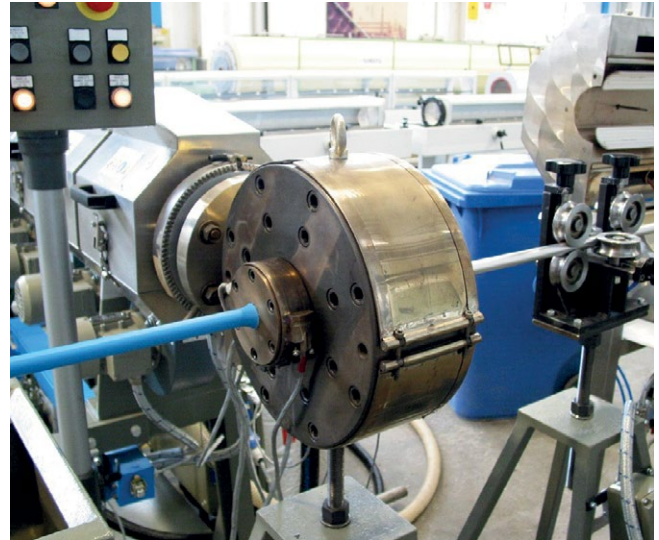

Overall, on the basis of results from the second National Survey by the MECS-Amaplast Statistical Studies Centre, the Italian plastics and rubber processing machinery industry is composed of over 400 companies (with 13,000 employees) that produced revenues of over 4 billion euros in 2021, representing a 12% increase over 2020.

Amaplast's full-year overview of 2021 is now completed by indicators relating to the first six months of 2022. With respect to the same period in 2021, orders are up by 10% and revenues by 14%, in light of the good performance of the domestic market. Expectations for the third quarter are still positive – thanks especially to foreign sales and orders – but naturally various political and economic issues, both in Italy and abroad, generate concern among operators.

► A Più S.r.l.  
[www.a-piu-srl.com](http://www.a-piu-srl.com)

Amaplast at K 2022: Hall 16, Stand A56

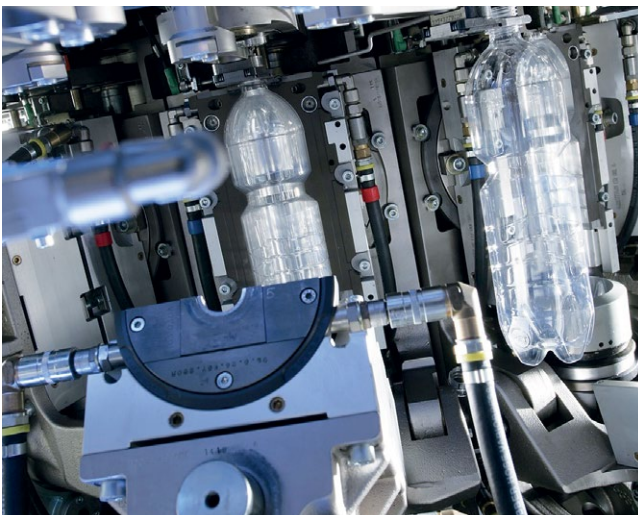

# Complete Lines for the Entire Extrusion Industry

For manufacturing virtually all kinds of extruded semi-finished products, battenfeld-cincinnati offers the right machinery and equipment, from customized single components all the way to optimized turnkey lines. The extrusion specialist based in Bad Oeynhausen, Germany thus serves customers from the pipe, profile and board industries as well as producers of film, sheet and granulates. "The special feature of our complete line is that they not only consist of perfectly synchronized individual components without any interface problems, but also come entirely from a single source", is how the group's Managing Director and CEO Gerold Schley describes its product range's unique selling point. At the K, battenfeld-cincinnati will visualize its complete line competence for the first time by unveiling the new, consistent design of its pipe extrusion lines, this year's winner of the coveted IF Award.

It is only logical, that the top issues of circular economy, digitization and climate protection at this year's leading world trade fair precisely reflects what is on the mind of the entire plastics industry. "Our motto 'Sustainable solutions worldwide' has lost none of its actuality, so we are presenting extrusion equipment in Düsseldorf this year which meets our customers' demands for concepts offering energy efficiency, space-saving footprints, low maintenance, flexibility and high performance", Gerold Schley emphasizes.

## Water management and new design for the pipe industry

At the K, battenfeld-cincinnati will unveil the new complete line standardised design, with which all pipe extrusion lines will be presented from 2023 onwards in the battenfeld-cin-

cinnati corporate colours. Apart from the visual effect, the functionality of the new design is the most important attractive feature: optimal accessibility and user-friendliness including easy cleaning features are the main attributes. All aggregates starting from the extruder to the calibration and cooling units and the vacuum tank, right up to the cutting saw and the tilt table, are manufactured in-house by battenfeld-cincinnati, perfectly matched not only technically and now also visually, without any interface problems, and integrated into the intuitive-to-operate BCtouch UX control system.

battenfeld-cincinnati offers complete lines for the pipe industry to cover an enormous diversity of applications, ranging from drip irrigation in agriculture right up to large-diameter pipes for water management. Both these extremes will be shown at the K booth. In large-diameter pipes, a new record has actually been set. The first lines to produce pipes up to 2,700 mm in diameter have been delivered. Two highlights of the large-diameter pipe extrusion lines are the pipe die with Optimelt, providing ideal melt homogenization with lowest melt temperatures to minimize sagging. With the completely new constructed 4 m long segments of the downstream unit battenfeld-cincinnati addresses the enormous dimensions of the equipment and the related transport problems. For the first time, there are vacuum tanks and spray baths which come in segments only 4 m long. These single aggregates can easily be transported and are easy to assemble on the production site.

Visitors to the K booth can witness battenfeld-cincinnati's drip irrigation expertise by a video presentation of the new line set up for customer test runs in its technical lab in Bad Oeyn-



soEX45

hausen. The highlight here are the drippers, which come in a design both simple and ingenious to ensure a very even continuous water dispensation. During the extrusion process these drippers, developed by battenfeld-cincinnati with a partner company, are shot through the pipe die and fully welded into the pipe at once while it is still hot. Drilling or punching holes in the drippers for the water outlets are no longer required. At the same time, the design of the drippers ensures a long service life on site without clogging of the water outlets with lime-scale, soiling or plant growth.

Another novelty at the K booth is the small soEX NG, which completes the high-speed extruder series for pipe extrusion at its smallest size. From now on, the soEX NG 45 will be available in addition to the four soEX NG models already existing in the sizes of 60, 75, 90 and 120 mm. A striking attribute of this series is the combination of internally grooved barrels with a matching special screw geometry, which offers several advantages: up to 40% higher outputs, about 10 °C lower melt temperatures and 15 % less energy consumption.

## Ideal extrusion solutions for eco-friendly products

Floor coverings based on highly filled plastics have experienced enor-

New pipe extrusion line





mous growth in recent years. These are often PVC-based formulations. In view of the sustainability discussions, it is becoming apparent that PP will take on a leading role in this area and partially replace PVC.

The requirements for floor coverings in terms of absence of tension, flatness and thickness tolerance are extremely high due to the following processing steps, such as printing, as well as the later application area. The semi-crystalline structure of PP makes the task even more difficult.

It turns out, that for the production of environmentally friendly floor coverings made of PP the Multi-Touch roll stack from battenfeld-cincinnati is very suitable. This was clearly demonstrated in practical use by several first customers. This unique roll stack, equipped with up to nine cooling rolls for pre-calibration and re-calibration, ensures a long phase of intense contact between the board and the cooling rolls after the melt has left the flat die. The cooling of the top and bottom side takes place almost simultaneously. In this way, a dimensionally accurate, visually attractive semi-finished product with ideal flatness and lowest thickness tolerances is created, which is perfect for flooring applications. Yet not only for floor coverings, but also for manufacturing refrigerator panels or other surface panels made of PS or PP, the roll stack is in demand internationally and already being used in many countries. At the K booth, a Multi-Touch roll stack will be exhibited, so that interested customers can exchange views with the relevant specialists about its wide range of applications, which even include the production of thin film smoothed on both sides.

battenfeld-cincinnati also offers perfect extruders for the PVC industry. The most recent proof is the new pelletizing extruder series aglomEX, available either with or without electrically driven shear gap adjustment (EMS). These extruders are suitable not only for virgin material, but also for PCR goods originating, for example, from the Rewindo collection system. The immediate eye-catcher on the model aglomEX 114 to be showcased at the booth is



the processing unit lengthened by 6 D, with which all five models have been fitted. In this way, the extruders not only meet the demand of the PVC industry for capacity to process a range of raw materials as wide as possible, but they also achieve up to 20% higher output rates in response to the general call for high efficiency.

**On course towards fully automatic extrusion lines**

Automation and digitization not only facilitate daily production processes, but also fulfill the requirements for high efficiency in production, reduced set-up times and low scrap rates. Impressive examples are the systems developed by battenfeld-cincinnati for pipe and sheet production and presented at this year's K. Fast dimension change (FDC) is a system which enables changes of pipe dimensions within a wide range of diameters at the push of a button during production. Not only the melt gap on the pipe die, but also all downstream aggregates adjust themselves simultaneously to the new pipe dimensions without any manual intervention. So, pipe manufacturers are able to fill even small-volume orders efficiently and to minimize the amount of scrap as well, which makes their production eco-friendlier. Similar helpers in daily production are on offer for sheet and board extrusion lines. For instance, combined operation of the extruder and the melt pump in sheet extrusion significantly facilitates start-up. This saves time and costs and minimizes start-up scrap. Automatic adjustment of the flat-sheet die and

the roll stack, as well as the roll compensation system, also simplifies the operation and increase the efficiency in production.

At the K, battenfeld-cincinnati will also present Steady flow from its extensive range of individual modules, which is the solution to reduce pressure fluctuations in PVC extrusion. In the counter-rotating conical twin screw extruders frequently used in PVC extrusion, pressure fluctuations inside the die are unavoidable, due to the chamber profile. Yet these fluctuations may degrade the quality of the semi-finished product. Steady flow takes care of measuring the pressure at the screw tip, and on that basis constantly readjusts the screw speed. This minimizes pressure fluctuations and consequently pulsations in the melt flow, which in turn ensures significantly better semi-finished product quality and reduces the amount of scrap.

Gerold Schley is confident: "With our trade fair presentation, we will impressively demonstrate that we have understood the needs of the industry and are offering solutions. These range from optimized individual components to complete lines, including digitization tools as well to facilitate daily production and to enhance production efficiency in every aspect". He is looking forward to many interesting and above all face-to-face conversations in Düsseldorf.

➔ **battenfeld-cincinnati**  
[www.battenfeld-cincinnati.com](http://www.battenfeld-cincinnati.com)

**K 2022: Hall 16, Stand B19,  
 FG-CE12**

*Digitisation*

# Intensive Cooling “Short Stack” Technology

Addex, a leading supplier of high-performance blown film cooling equipment, will launch the latest iteration of its patented Intensive Cooling™ technology, the “Short Stack,” at the upcoming K 2022 exhibition in Düsseldorf, Germany.

Short Stack is a major upgrade to Addex’s Intensive Cooling system which was first introduced at K 2016. It typically delivers a 25% increase in output over the company’s original Intensive Cooling “Down-on-the-Die” version, which already improves output by 10 to 15% over conventional dual-flow air rings.

“We’ve taken our Intensive Cooling technology to the next level, affording processors even greater output and productivity,” said Bob Cree, President of Addex Inc. “Intensive Cooling products will continue to evolve, fueled by ever more demanding customer processing requirements.”

Intensive Cooling is Addex’s unique approach to cooling the bubble which changes the common aerodynamics of present-day blown film air rings to dramatically increase stability and output. Addex has successfully added additional high-velocity air streams to the traditional single, high-velocity “main lip” air stream common to all air rings. Each new high-velocity air stream naturally provides a firm stabilization “lock point” that not only provides intense cooling, but also firmly holds the bubble in place, providing what some processors call “incredible bubble stability.” Another unique design element is sealing the air ring to the top surface of the die. Positive stabilization and high-intensity cooling can begin earlier in the process, literally just above the die lip, which makes hard-to-run films capable of running at higher output speeds.

In the new Short Stack configuration, the bubble is pulled through a circular enclosure located between the die and air ring that naturally pulls the bubble into an oversized air ring which further increases output. Unlike other raised-up systems that are difficult to start up because the bubble must be pulled out and around equally oversized internal bubble cooling (IBC) hardware (which is required to push the bubble outward into the air ring), the Short Stack does this naturally, so it can be run with or without conventional IBC hardware.

The Short Stack incorporates an additional Intensive Cooling element that adds two more high-velocity air flows to the original Down-on-the-Die version released in 2017 (which had one additional lock point), for a total of three locking points, guaranteeing substantially higher output rates due to the increased stability, which



*Short Stack trials running 90% 1MI LLDPE rich blend demonstrate a 28% increase in output over Addex’s original Intensive Cooling™ “Down-on-the-Die” version, which already improves output by 10 to 15% over conventional dual-flow air rings*

in turn allows for processing much lower melt strength materials than possible before. Another major advantage is that few, if any adjustments are needed, even with material changes, making it easy to run.

The Addex Short Stack is proving to be successful over a wide range of processes including larger blow-up ratios/thin materials; smaller blow-up ratios/thick materials; along with high-melt strength as well as very low-melt strength processes. The company guarantees an output increase of 20 to 30% for retrofits. Since Short Stack is not height-adjustable and adds three more points of stabilization, it doesn’t require a highly trained operator to run it, unlike other height-adjustable raised-up systems.

► Addex Inc.  
[www.addexinc.com](http://www.addexinc.com)  
 K 2022: Hall 17, Stand C41



# Using Sustainability as a Success Driver, Benefiting from Digitalization, Increasing Productivity

The Reifenhäuser Group will be represented with four booths at the world's leading trade fair for plastics processing, K 2022. Under this year's Reifenhäuser motto "The Time is Now", the extrusion specialists will show producers of films and nonwovens valuable solutions for the three major topics of the industry: sustainability, digitalization and productivity.

Bernd Reifenhäuser, CEO of the Reifenhäuser Group, explains: "The world and our industry are facing major challenges. There is uncertainty, disorientation and unanswered questions on many topics. And yet they will not tolerate any delay. Now is the time to act and turn challenges into opportunities. We have know-how for this as well as great, immediately applicable solutions in our luggage, with which we enable our customers and partners to do so."

The Reifenhäuser Group will be represented at three of its own booths and one joint booth in Duesseldorf. The main booth with approximately 1,200 square meters is located in Hall 17 (C 22) and showcases the Reifenhäuser Blown Film, Cast Sheet Coating and Reicofil business units. With the help of machine exhibits, visual presentations and concrete solutions for end products, visitors will learn, among other things, how they can manufacture fully recyclable products economically,



*Bernd Reifenhäuser,  
CEO of the Reifenhäuser Group*

process recyclates safely, increase their output and network the entire production without becoming dependent on systems, specialists or manufacturers. To ensure smooth production even after purchase, Reifenhäuser Service shows how customers can get the best out of their Reifenhäuser products and increase their productivity with rework solutions, modifications, training programs and digital services.

The component specialists of the Reifenhäuser Extrusion Systems business unit will additionally present their portfolio at two other exhibition booths. In Hall 11 (C16), everything revolves around screws, barrels and extruders – and why, especially for processing recycled material, high-performance wear protection is essential for reliability and high economic efficiency. The well-known Reifenhäuser Reiloy wear protection alloys for screws and barrels have repeatedly achieved top values in independent tests, proving that investing in high-quality wear protection pays off. In Hall 1 (D91), Reifenhäuser Extrusion Systems will showcase its innovations for flat dies and coextrusion blocks and their perfectly coordinated interaction for maximum productivity.

In addition to its own booths, Reifenhäuser will also be present as a partner of the R-Cycle initiative as part of a joint pavilion on the open-air site in the so-called Circular Economy Forum (CE 07). R-Cycle is a cooperation project of various technology companies and organizations along the entire life cycle of plastic packaging. The interdisciplinary team has developed an open traceability standard for sustainable plastic packaging that makes recycling-relevant information transparent by providing a Digital Product Passport. This enables waste sorting facilities to more precisely identify recyclable packaging and form recycling-friendly and single-variety fractions. This is the basis for obtaining high-quality recyclates to build a functioning circular economy.

A special highlight for visitors to the Reifenhäuser trade fair booths is the opportunity to additionally participate in the in-house exhibition on October 20, 21 and 24 at the Reifenhäuser Technology Center. For this purpose, Reifenhäuser organizes a free bus shuttle between the Duesseldorf trade fair and the Reifenhäuser headquarters in Troisdorf, which is only about 70 kilometers away. Here, the guests can experience various blown film and flat film lines in operation during two moderated live demonstrations per day. Interested parties can contact their Reifenhäuser representative to inquire about participation.

► Reifenhäuser Group  
[reifenhauser.com](https://reifenhauser.com)

**K 2022:**

Reifenhäuser main booth (blown film, flat film, nonwovens lines, service, digitalization, components):

Hall 17 / C 22

Reifenhäuser screws, barrels and extruders:

Hall 11 / C16

Reifenhäuser flat dies: Hall 1 / D 91

R-Cycle: Circular Economy Forum (CE 07)



# Smart Solutions to Increase the Sustainability of Film Stretching Lines

At this year's K-show, Brückner Servtec will present new, customized conversion packages (Line Transformation Packages) supporting the circular economy by recycle-ready film types on existing film stretching lines. New solutions for energy reduction and higher quality in the production processes further increase sustainability in film production. In addition, new functions of the established Brückner ONE Digital Service Platform will be shown, which considerably facilitate the maintenance and operation of film stretching lines.

The new Line Transformation Packages from Brückner Servtec are designed for the conversion of existing film stretching lines to the sustainable production of recyclable mono-material film types, such as BOPP, BOPLA or BOPE. The necessary conversion measures are individually adapted to the production line and are available for lines of any age. Together with the line operator, an on-site evaluation of the plant is carried out and from this the specific requirements for the conversion are identified.

- The Line Transformation Package BOPP – ILC (Inline Coating) enables the production of recyclable ultra-high barrier films (UHB) on existing BOPP production lines. The innovative Inline Coating (ILC) technology is a wet chemical coating (water-based) of plastic films, directly during film production. The step is performed between MD and TD orientation. The nano-

meter scale coating enhances further processing steps such as metallization, significantly reduces the use of foreign material content and thus allows the production of recyclable films according to EU Directive 94/62/EC.

- The new Line Transformation Package BOPP – PE extends the product portfolio of all BOPP film stretching lines by the option LLDPE or HDPE. BOPE films have very good mechanical properties, allow replacement of blown film PE on only half of the thickness, and thus enables mono-material structures which are fully recyclable. The necessary modification steps, typically in the extrusion, casting unit and MDO areas, are individually tailored to the line and situation on site.

The hybrid machine design, optimized for high output, offers operators the choice of continuing to produce BOPP at full output as well as BOPE film profitably.

- The Line Transformation Package BOPET – PLA allows the production of this biobased raw material. BOPLA films offer excellent moisture transmission properties, have a high natural level of surface tension and are industrially compostable. The conversion package combines all necessary adjustments in the field of extrusion and raw material feeding with the necessary process know-how to produce PLA films in high quality and at high output.

The Brückner ONE digital service products were presented to the global

public at the K 2019 and since then have been installed in more than 350 production lines worldwide, representing almost 50% of connectable assets. Customers benefit from the globally available online modules for services, spare parts management, easy communication, and advanced line documentation. All at highest data security certified by TÜV Nord. New modules and functions for Brückner ONE will be presented at this year's K show:

- Automatic language switching is available for the service module and enables easy conversations of customers and service specialists in their native language. A new online AI routine automatically translates all input into the user's preferred language. Currently, more than 20 languages are supported in addition to English, Chinese, Japanese, Spanish or Portuguese.

- The new Brückner ONE Maintenance Plan Assistant is the entry into the world of preventive and predictive maintenance and makes service easy and plannable. The system uses sensors and algorithms to continuously check the condition of the plant and installed components and informs the plant operator as soon as a maintenance action is necessary. The Maintenance Plan Assistant module guides the user conveniently through a range of steps from the procurement of spare parts to the automatic creation of a service case and detailed maintenance instructions. The module is intended to be expandable to

Brueckner ONE Smart Service Solutions



Line Transformation Packages





the plant operator's entire production chain and can support up- and downstream components such as slitters, metallizers, crane systems and more.

To increase the sustainability of film production, Brückner Servtec is showing a wide range of modernization measures that reduce energy consumption while increasing output and film quality. This significantly extends the lifecycle of production equipment. Among others these are:

- Direct drives for all significant line drives from extrusion to winder to reduce power consumption while improving film quality through optimized speed and torque control

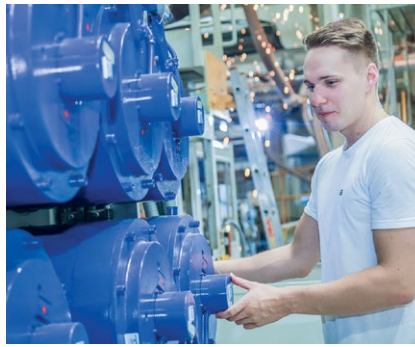

*Line Upgrades Improve Production Sustainability*

- Smart Swivel Roll intelligently cools the film in the water bath at the chill roll by adjusting its position

based on film thickness and output. Thus, reducing the heating – and energy use – at the following MDO to a minimum

- New Control Systems not only replace obsolete hardware for production safety but moreover install latest software for an easy, efficient and energy saving line control
- Expert audits for process and energy optimization in film production

➔ Brückner Servtec GmbH  
www.brueckner-servtec.com

K 2022: Hall 3, Stand C90

## Technology Innovations at K 2022 – *Higher Plant Efficiency for Sustainable Film Production*

In the fight against climate change, it will not be possible to do without plastic packaging that is produced in a way that conserves resources in the foreseeable future. That is why Brückner Maschinenbau is sticking to its ambitious goals for further increasing efficiency in film production in addition to the developments for the rapidly developing circular economy. This means decreasing raw material use, ever lower energy consumption and "zero waste" in film production.

### Faster and wider BO plants

The more efficient and higher output a film stretching line is, the lower the specific energy consumption. These parameters can mainly be influenced by the line speed and the line width.

BOPP and BOPET:

In the production of the two most popular packaging films, BOPP and BOPET, the benchmark in production speed has so far been around 600m/min. At K 2022, Brückner Maschinenbau will present new line concepts with significantly higher running speeds.

BOPA:

BO films made of polyamide are particularly suitable for packaging

oily, fatty foods and for frozen foods. The demand for this is continuously increasing and with it the demand for corresponding film stretching lines.

At K, Brückner Maschinenbau will present new line types with up to 80% more output – based on an increase in production speed from 220m/min to 350m/min and a line widening from 6.6m to 7.4m.

Battery separator foils and capacitor foils:

In these segments, the previous (already exclusive) line width of 5.5m is being increased step by step to over 6m and the associated increase in output of over 20%. In addition, both the sequential and the simultaneous stretching technology for capacitor films were further developed: the focus was on higher film yield and optimised film properties, especially for films in the 2 µm range.

### Technical innovations for more sustainability in film production

Direct recycling:

Thanks to a new type of "direct fluff Ddosing", the edge trimmings and waste produced during production can be directly fed back into the

extrusion process in a higher percentage – without any prior re-granulation process. This saves energy, conserves raw material and comes very close to the goal of "zero waste" in production.

Intelligent stretching oven management:

Instead of the heat exchangers previously used for heat recovery, a patented, energy-efficient oven control system across all temperature zones of the stretching oven now ensures an energy saving of around 200 kW per year.

### Aerodynamic zone separation

The patented process guarantees even better and more uniform film quality across the entire working width and for ever higher production speeds. This increases the proportion of A-grade film on the winder, reduces production waste and lowers specific energy consumption.

➔ Brückner Maschinenbau GmbH & Co. KG  
www.brueckner.com

K 2022: Hall 03, Stand C90

# Sustainable and Digital

**K**IEFEL will be presenting machine, tool and automation solutions for processing recyclable materials at this year's K trade fair with live demonstrations. The company is also showcasing new digital services, solutions for the medical and pharmaceutical industries and research activities on the topic of sustainability. In addition, Kiefel is offering insights into processes for closing the cycle at "The Machine" in the VDMA Dome.

"At Kiefel, we keep our eyes on the megatrends of digitization and sustainability," explains Cornelia Frank, Head of Sustainability at Kiefel. "That's why we are particularly pleased to be presenting solutions at this K trade fair that ideally match this year's focal topics of circular economy, digitization and climate protection."

## Sustainable packaging solutions from a single source

As well as classic, bio-based and recycled plastics, Kiefel steel rule and tilting machines can also process paper. In live demonstrations of the KMD 78.2 Speed steel rule machine, the company will illustrate how high-quality, sustainable packaging products are made from recycled film – thus making a contribution to tray-to-tray recycling. This is made possible by in-house, unique tool technology and smart automation concepts. Kiefel is unveiling the new Kiefel Standard Automation (KSA) at the K. Beside customer-specific automation solutions, the company thereby offers completely modular standard automations based on a building block principle for the most common applications.

In addition, visitors can discover more about the latest packaging technology from Kiefel, fiber thermoforming of natural fibers, which is in high demand worldwide. Large numbers of the NATUREFORMER KFT 90 machine, which deploys this technology, are already operational worldwide. At the K 2022, the KFT Lab laboratory machine will be used to illustrate the production process and suitable food and non-

*Kiefel machines can produce a wide range of packaging made from classic, bio-based or recycled plastics*

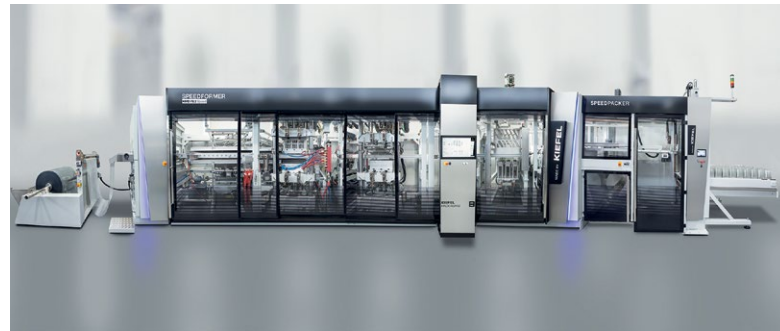
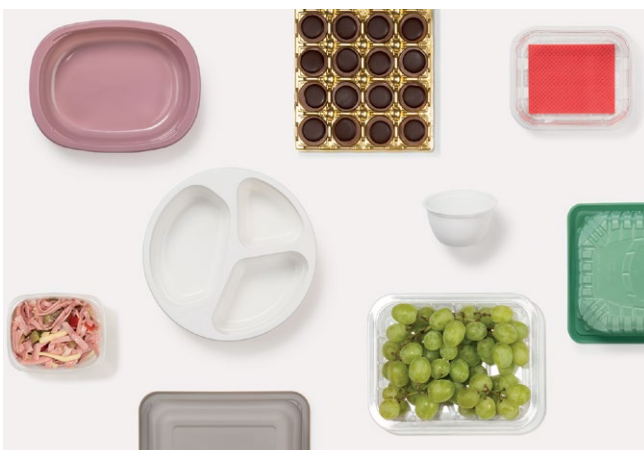

*The KMD 78.2 steel rule machine is an efficient all-rounder – and is capable of processing recycled film (All pictures: © KIEFEL GmbH)*

food applications for the technology. With its own material and technology centers, Kiefel offers extensive capabilities for proofs-of-concept, which will also be featured.

## Research activities for a better circular economy

Kiefel is committed to increased sustainability in many ways, and has anchored this in its corporate strategy, is EcoVadis-certified and is involved in various research initiatives for a better circular economy. At the booth, visitors will gain an insight into new research activities and results from initiatives such as HolyGrail 2.0, PrintCYC and NextLoop.

## Service: Machine status and maintenance at a glance – 24/7

In Kiefel's After Sales division, the range of digital services has been expanded. The Kiefel Portal is the central online platform that allows customers to keep an eye on their machine status around the clock using the "Maintenance Dashboard" and plan upcoming maintenance. Furthermore, users are also informed about suitable machine upgrades. The Kiefel portal can also be used to identify and request machine spare parts,

*At the K 2022, Kiefel will also be presenting fiber thermoforming technology and the potential applications of thermoforming with natural fibers*

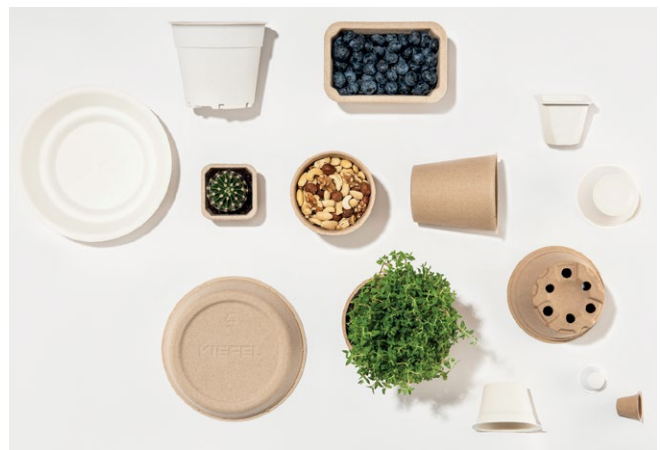



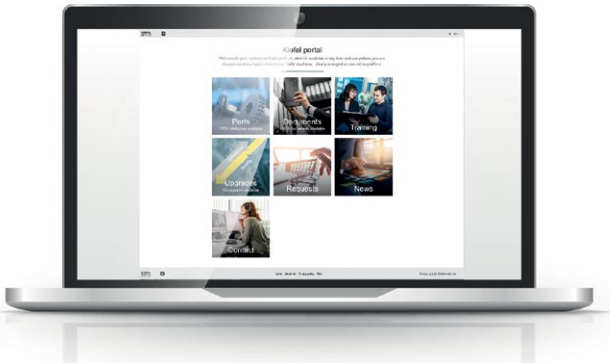

The functions of the digital Kiefel portal are constantly being developed and enhanced. In future, customers will also be able to complete online training and keep an eye on the status of their machines around the clock



Recently Kiefel launched machine solutions for the production of 2D or 3D bioprocess bags

3D machine documentation and new interactive online training courses on all aspects of machine operation.

### Medical & Pharma: Production of Bioprocess Bags

Simultaneously, Kiefel is presenting innovations for the medical and pharmaceutical industry. At the K trade fair, the company is exhibiting its expanded portfolio of bioprocess bags with the requisite machine technology. The 3D and 2D bags can be made from PVC-free materials such as PE or PP, or from PVC or EVA, depending on the customer's require-

ments. Depending on the customer's requirements, a wide range of options can be implemented, e.g. semi-automatic or fully automatic machines, disposable bags for the storage of stem cells, cell cultures, mixing or separation, in 2D or 3D designs or hose/port connection components.

➔ KIEFEL GmbH  
www.kiefel.com

K 2022: Hall 3, Stand E 90

# New System to Improve Pellet Cooling and Ejection

In May 2022, MAAG Group acquired the French tool manufacturer AMN DPI (AMN), thus continuing its growth as an integrated supplier of systems for the plastics industry.

For the first time, a complete AMN Central Injection System (CIS) consisting of a 1500 mm diameter die plate with a central water injection and sword shaped knives will be displayed at the K-Show. CIS was designed to improve pellet cooling and ejection and is an effective solution for high melt index or peroxidized polymers.

MAAG Group systems play a key role in the plastics circular economy. Along with keeping post-industrial and post-consumer waste in the value chain, we provide technologies that target the efficient use of resources; an additional factor in sustainability. In this

context, the products of the globally positioned AMN complement the MAAG Group portfolio and provide additional value to customers for all polyolefin applications.

Die plates are the heart of the underwater pelletizing system; necessary to produce high quality and consistent pellets. Over many years, the unique technologies of AMN die plates have demonstrated their performance and longevity in many applications, especially for high capacity underwater pelletizers.

➔ MAAG Group  
www.maag.com

K 2022: Hall 9, Stand A02



# Circular Economy: Digitalization Makes the Decisive Difference

**W**e all know it: waste plastics are actually raw materials. However, this does not change the fact that far too little of this waste is recycled and returned into the material cycle. At K 2022 KraussMaffei will not only exhibit the necessary machinery, but also new digital solutions that enable maximum savings to be achieved in terms of energy consumption and carbon footprint.

Especially in the healthcare sector, the worldwide demand for disposables is enormous. Very often the products are only used for a short time and exhibit minor contamination. These are ideal conditions for subsequently using them as raw materials for components designed for a longer service life. At the KraussMaffei booth, visitors will be able to see for themselves how insulin pen caps are converted into door modules for cars, for example.

## Material cycle at K 2022: from insulin pen caps to automotive door modules

Interested visitors can get a live experience of the entire process: A fully electric PX 200-1400 produces 96 insulin pen caps per shot from medical polypropylene virgin material. After



*The socialProduction family enables location and time-independent monitoring of machinery and production processes*

shredding, these caps serve as base material for the up-cycling process carried out on the ZE28 BluePower twin-screw extruder. Here, various additives such as bonding agents and liquid pigments are added, mixed and homogenized. The resulting re-compound is transferred to the downstream injection molding machine – more precisely to the new powerMolding 1300-11900. This newly developed series is based on the proven two-platen technology that stands out for a range of highly standardized options and is designed

as cost-effective variant in particular for nearly standard applications.

## Reduced carbon footprint and lower energy costs in line with a strong environmental conscience

With the application shown at the KraussMaffei booth at K 2022, all sustainability-relevant process data are recorded and displayed, so that the amount of CO<sub>2</sub> saved by the recycling process as compared to the use of virgin material is evident at any time.

*At K 2022 KraussMaffei will demonstrate the complete material cycle from the insulin pen cap up to the door module using a wide range of innovative digital solutions (Photos: KraussMaffei)*







Both, a smartphone app and a web application for PC or tablet are available for the use of the socialProduction option

Together with Motan, for instance, an application has been developed that shows the energy consumption of each process step. This application enables processors to specifically re-

cord and improve their energy consumption. The digital ACP-plus solution has been optimized and is now better adapted to the processing of reclaimed material. It reduces production scrap thanks to the automatic re-adjustment to changing ambient conditions such as temperature or air humidity during the injection molding process. During machine start-up as well, the nominal process values are achieved much faster, which results in substantially lower start-up scrap. The dataXplorer provides in-depth process data by capturing up to 500 machine signals in real time for the carbon footprint measurement. Any deviations from the pre-defined tolerance ranges can thus be detected instantly.

**KraussMaffei**  
[www.kraussmaffe.com](http://www.kraussmaffe.com)

K 2022: Hall 15, Stand C15/C24-D24

# Full Range of Plant-Based Polymer Additives

Palsgaard will take the opportunity of K 2022 in Düsseldorf, Germany, to position itself as a preferred supplier to polymer producers, masterbatch manufacturers and compounders seeking to lower their carbon footprint and go renewable. At the world's largest plastics trade fair Palsgaard will present its complete portfolio of sustainable polymer additives and offer first-hand insight in new developments.

"As the plastics industry is transforming from a linear to a circular economy, there is a fast-growing demand for renewable alternatives to conventional fossil-based formulations," says Ulrik Aunskjær, Global Business Director, Bio Specialty Additives at Palsgaard. "Beyond the more basic raw materials feedstock, this also applies to functional additives, where common synthetic chemistry is under increasing regulatory pressure while consumers demand more natural, safe and healthy ingredients also in the polymers in which their products are packaged. At Palsgaard, we are addressing these issues with a full range of plant-based, food-grade polymer additives, backed by advanced customer and application support."

In packaging plastics, Palsgaard's Einar® additives serve as highly effective anti-fog and anti-static surfactants, dispersing aids, ageing modifiers, EPS coatings and mould release agents. At K 2022, the company will introduce new plant-based innovations in its growing portfolio, developed and optimised at Palsgaard's Polymer Application Centre in Denmark to help customers stay ahead of increasingly stringent regulations, such as on food-contact, without compromising performance or quality. All of these products provide an excellent drop-in replacement for fossil-based additives in existing polymer formulations and have a perfect fit in new responsible packaging solutions.

Furthermore, Palsgaard will also update K 2022 visitors on significant investments made into the future of its poly-



Einar® polymer additives are plant-based and food-grade and can be used for a variety of applications in PE and PP, such as anti-static additives, anti-fogging additives, anti-fouling additives, colour dispersing aids and mould release additives (Photo: Palsgaard A/S)

mer additives business. The expansion of the company's carbon-neutral production capacity is proceeding as scheduled. After the successful commissioning of a new emulsifier pellet line with a capacity of 10,000 tonnes in 2020, the Juelsminde site will receive a state-of-the art spray tower, which is expected to go on-stream in the fourth quarter of 2023 and add 30,000 tonnes to Palsgaard's existing spray capacity. This will be complemented by multiple new reaction, distillation and esterification plants, altogether doubling the company's overall production capacity by 2024.

In addition, new sales offices in Brazil, the United States and China will strengthen the support of customers in these regions, as Palsgaard is delivering on its strategy to develop long-term close partnerships and grow its global service capacities.

**Palsgaard A/S**  
[www.palsgaard.com/polymers](http://www.palsgaard.com/polymers)

K 2022: Hall 7, Level 1, Stand D20

# Sustainable Machinery Performance and Smart Factory

Davis-Standard will exhibit machinery and process solutions that highlight a commitment to value, innovation, and sustainability during the upcoming K 2022 Show. Technology from the Davis-Standard family of companies, including Davis-Standard, Maillefer, Brampton Engineering, Deacro and Thermoforming Systems LLC (TSL), will be shown with an emphasis on customer profitability and performance. Visitors will experience continued developments in extrusion and converting technology focused on a circular economy, energy efficiency, reduced power consumption and minimized waste, as well as a live demonstration of smart factory connectivity.

"As the first K show since 2019, we look forward to engaging with our global customer base and sharing new developments," said Giovanni Spitale, Davis-Standard President and CEO. "Our exhibit will present a range of technology from Davis-Standard and our heritage brands that reflects marketplace demand and our strong commitment to sustainable manufacturing practices. We also have an intense focus on the lifecycle value of our machinery as reflected in our aftermarket services."

Davis-Standard has been active since the last K show, and is eager to introduce enhancements and developments to its expansive machinery portfolio. Following is a summary of technology to be shown and/or promoted:

*XP Express-AGT™ – Davis-Standard's latest roll stand providing greater automation and process control for sheet extrusion applications (not for sale in Germany)*



## Aftermarket Advantages –

Davis-Standard and all portfolio brands offer end-to-end service, parts, and line upgrades to help customers maximize productivity. The company continues to push the envelope with smart factory solutions and connected machinery developments designed to integrate with a customer's plant to provide real-time monitoring and diagnostic capability. For example, Davis-Standard's new DS Activ-Check™ platform can be installed on a continuously expanding number of company products (including both Davis-Standard and Maillefer machinery), delivering a powerful suite of analytical tools, cloud and local data storage options, process and equipment technology algorithms. A live demonstration of how customers can benefit from this technology will be given during the show.

## SHO Extruder (3.5-inch, 90mm) –

Equipped to save space while offering outputs of at least 20 percent versus existing groove feed models, the SHO is engineered with a new gearbox, an optimized feed section, and high-performance, energy-efficient DSB® barrier screw. This is especially beneficial for high-viscosity HDPE applications such as pipe extrusion, where lower melt temperatures, reduced power consumption and improved energy efficiency are paramount. This model is not for sale in Germany.

## MXD Extruders –

Maillefer's new MXD series high-performance extruders will be on display in 45mm and 80mm sizes. Besides the two extruders will be three ECH extrusion heads dedicated to three application areas; micro-drip irrigation, blown fiber microduct, and heating and plumbing applications. Downstream equipment will also be shown, featuring the most recent dual coiler and reeler technology with robotized handling capabilities.

## Model 4000A Crosshead –

In elastomer, Davis-Standard will promote the Model 4000A crosshead, which allows for faster start-up times



*SHO Extruder (3.5-inch, 90mm) – higher performance Davis-Standard extruder*

and little scrap. The Model 4000A incorporates an automatic, servo-driven concentricity and wall thickness adjustment system. This new, proprietary and patent pending, system automatically adjusts core tube/tip assembly to minimize eccentricity, maximize concentricity, and reduce downtime during product changeovers. This automated design has a tapered mandrel and highly engineered flow paths to ensure consistent flow through all speed ranges.

## Extrusion Die 510A –

Engineered for packaging, cup stock, board and paper, foil, and film applications, the 510A offers simplified operation, improved safety and reduced waste. A short die lip facilitates minimal edge bead, excellent cross profile, and needed flexibility for processing various polymers at changing web widths. The motorized deckling adjustment promotes safe operation, and an optional way-encoder reduces waste during product changeover. The corrosion-resistant chrome nitride surface enables a sharper die exit edge to minimize polymer build-up and increase running time.

## Extrusion Laminator –

A laboratory-style linear three-roll laminator with a 900mm chill roll will be shown. This design is engineered for a high cooling capacity at high speed operation, and with a hydraulic linear nip pressure system to support a range of flexible packaging substrates. Advantages include a water-cooled hydraulic



actuated take-off roll for gap and contact operation; process rolls with a quick release water connection and simplified roll change function; and a motorized Teflon tape system and belt adjustment for safe, uninterrupted operation.

#### XP Express® AGT –

As the latest addition to Davis-Standard's roll stand portfolio, this model provides greater automation and process control for sheet extrusion applications. With a space-saving, multi-roll design, processors can

take advantage of advanced cooling and polishing, die-to-nip management, web flatness, heat transfer, consistent sheet clarity, and improved performance for low melt-strength resins. This model is not for sale in Germany.

#### Feedscrew Display –

A single screw extrusion plastication model will show the transformation of raw plastic material into melt as it is pushed to the front of the screw through a rotational action.

A single-stage metering screw and single-stage barrier screw will also be displayed. These designs illustrate the mixing quality and efficiency of Davis-Standard's screw technology in conveying, compressing, and blending melted pellets and color additives into a homogeneous melt stream.

➔ Davis-Standard, LLC  
www.davis-standard.com

K 2022: Hall 16, Stand A43

## „Quality Works“

LANXESS will be exhibiting at K 2022 in Duesseldorf under the motto "Quality Works". The specialty chemicals company will present material developments as well as new processes and technologies for the plastics industry at its 700-square-meter booth. In addition, sustainable products and system solutions for the rubber and polyurethane industries will be on display, as well as colorants and intermediates for the polymer sector.

LANXESS' focus topics for this year's trade fair are electromobility and sustainability. "We want to play an active role in the transformation of the economy and global value chains towards a more sustainable world," says Dr. Hubert Fink, member of the LANXESS Board of Management. "With our materials, we support our customers in manufacturing more sustainable products that have a lower carbon footprint and conserve resources and the climate."

The High Performance Materials business unit focuses on sustainable material and lightweight solutions. Main areas are materials and component concepts for consistent lightweight construction in the future market of electromobility.

Furthermore, the business unit will present new Tepex composites based on recyclates or bio-based raw materials. One example here is Tepex dynalite Scopeblue 813, which has just been launched on the market and is produced from flax fibers and

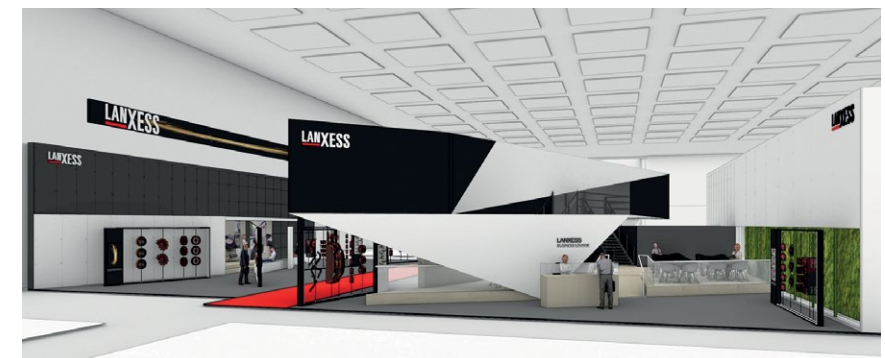

polylactic acid. Also on show will be a Tepex dynalite with a polyamide 6 matrix that is produced starting from "green" cyclohexane and therefore consists of well over 80 percent sustainable raw materials.

LANXESS' Polymer Additives and Inorganic Pigments business units offer the plastics industry high-performance, sustainable colorants for direct coloration. The business units will present their product ranges for the energy-efficient production of colored plastic goods, which eliminate the need for subsequent coating and thus avoid reworking. This includes both universal products and specialties for particular requirements.

With brominated and phosphorus-based solutions, LANXESS' Polymer Additives business unit offers one of the most comprehensive ranges of organic flame retardants in the world. The polymeric and reactive flame retardants reduce the release of additives from polymers, thus contributing to environmental and health protec-

tion without compromising fire safety. Due to their high efficiency, brominated flame retardants are widely used in the construction and electronics industries. In addition to effective fire protection, phosphorus-based flame retardants offer other advantages such as good processability and high elasticity in PU and PVC systems.

A wide range of additives for the rubber processing industry will be presented by the Rhein Chemie business unit. These include predispersed chemicals, processing promoters and vulcanization and filler activators. In the spirit of advancing sustainability, the focus will be on not only rubber production but also the manufacture of high-quality, long-lasting rubber products designed for a whole range of applications such as tires, hoses, seals, profiles, and drive belts.

➔ LANXESS AG  
lanxess.com

K 2022: Hall 06, Stand C76+C78

# Multi-Touch Roll Stack is Good for our Feet

*The sustainable plastic floor boards made of CERAMIN by CLASSEN for healthy living are recently being produced on a complete extrusion line with a Multi-Touch roll stack from battenfeld-cincinnati Germany GmbH. CLASSEN, based in Kaisersesch, Germany, is the inventor and manufacturer of these innovative, PVC-free floor coverings with the “Blue Angel” seal of quality.*

CERAMIN is produced from polypropylene as base material. It is pollutant-free, 100 per cent recyclable and produced with recycled materials. The sturdy, durable floor coverings based on CERAMIN offer all the advantages of plastic flooring for private residences as well as for public and industrial buildings. The floors are dimensionally stable, abrasion- and water-proof, warm to the touch and resistant to UV light.

Conventional plastic floors based on soft PVC have the disadvantage of poor recyclability and are subject to criticism due to their pollutive ingredients such as chlorine, stabilizers, phthalates and other plasticizers. This is why the CLASSEN Group has developed CERAMIN as a material for the carrier boards of PVC-free floor coverings. In detail, CERAMIN boards consist to 60% of a natural mineral filler material, to 39% of polymers based on polypropylene, and to 1% of environmentally friendly and health-compatible additives. The carrier boards in plastic floors from CLASSEN are covered with a protective undercoat as well as a primer and decorative layer with a soft-touch surface finish to make human feet feel comfortable.



In the production of the main component, that is, the 2-to-5-mm-thick board, it is of course vital that the board is absolutely even, has a clean, ripple-free surface and complies with extremely narrow strength tolerances. This is important for further processing as well as for its later use as floor covering. In the battenfeld-cincinnati line, the impeccable quality standard of the CERAMIN board with high filler content is primarily due to the Multi-Touch roll stack. Due to continuous contact between the board and the rolls, this device ensures perfect conditions for calibration and cooling.

The two lines now installed at CLASSEN are equipped with two twin screw extruders from Leistritz Extrusion GmbH, based in Nuremberg/Germany, which are connected to the dosing unit and ensure perfect homogenizing of up to 8 t of melt per hour. Downstream, these are connected to an auto-matic flat-sheet die, through which the melt film proceeds into the 2.6 m-wide Multi-Touch roll stack. Here, pre-calibration takes place in a two-roll stack, before the board passes through several more rolls for recalibration. In this way, the surface of the board is continuously in contact with the roll surfaces over a considerable period of time, with the result of perfect dimensional stability and excellent visual attributes. The haul-off is followed by a size cutter. The complete line is controlled by BCtouch UX, which is integrated in the customer's PDA system. In a second processing step, the boards are laminated as described above with the various layers of film and thus provided with a decoration chosen from a large, diversified range of patterns.

► battenfeld-cincinnati Germany GmbH  
Bad Oeynhausen, Germany  
[www.battenfeld-cincinnati.com](http://www.battenfeld-cincinnati.com)

CLASSEN  
[www.classengroup.com](http://www.classengroup.com)

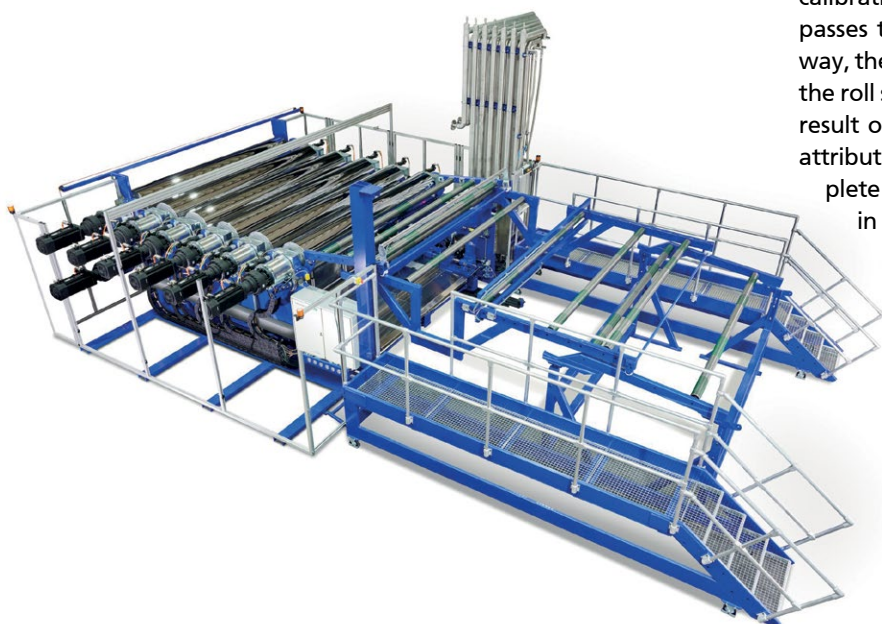





Find us here:  
hall 1, booth D10

# Clean. Nothing else.

## The upgrade to your high-quality production line

### Polymer melt filtration by BB Engineering

High-quality polymer products start with highly-purified melt. As a retrofit to your plant our polymer filtration systems guarantee a perfect melt quality for many demanding applications.

- ✓ long service time
- ✓ high degree of fineness
- ✓ filtration area 0,4-40 m<sup>2</sup>
- ✓ different filter media

More info here: [www.bbeng.de](http://www.bbeng.de)

**BBENGINEERING**  
The Valueneering Company®

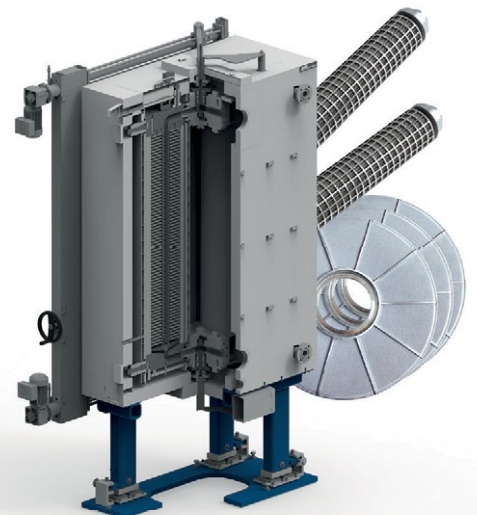

# Trends in the Extrusion of Plastic Pipes

*Bausano instructs Massimiliano Fenili, as Technical Manager in charge of supervising the design of systems for the various application areas: granules, pipes, profiles, WPC, medical sector and for recycling. The appointment of Fenili falls within a broader project in which Bausano is committed to strengthen its own team. The Manager's high expertise in pipe extrusion technology is aligned with the corporate strategy of being one of the main players in the market for such solutions. We shall examine the trends in the sector directly with the expert.*

**Massimiliano Fenili, what are the application areas in which the use of plastic pipes is increasingly widespread?**

*Fenili:* In general, we can say that demand is moving towards more efficient solutions. This is translated into an increase in the demand for polyethylene (PE) pipes, a material that guarantees important benefits in terms of reducing installation times and costs, even up to 50%, thanks to its flexibility, ease of installation and possibility of trenchless installation or without a sand bed. Specifically, PE100 RC is frequently used thanks to its higher mechanical performance, resistance to external abrasions, reduction of the propagation of cracks and resistance to high pressures. To mention two areas in which demand has grown, we may certainly consider the infrastructure sector, for gas pipes, pressurised and non-pressurised water, and the telecommunications sector. The first one searches, most of all, for multilayer pipes capable of carrying out various functions, from resistance to high pressures up to reducing installation costs. On the other hand, in the telecommunications sector the diffusion of optical fibre at a domestic level encouraged the study of new types of piping and installation, from the single microduct to the bundle, fender and round structures.

In addition to the aforementioned polyethylene, multilayer polypropylene (PP) pipes are certainly expanding, which combine maximum flexibility and resistance to several climatic conditions capable of carrying out various functions: from the reduction of noise for the drain pipes, to the ability to resist to very low temperatures. Furthermore, the combination of PVC and polypropylene is often chosen as an alternative aimed at keeping costs down. Alongside PE and PP, there are also PEX, PERT and PB materials, used in the healthcare sector, especially in the multilayer versions with oxygen barrier. While C-PVC, specifically, is already widespread in India and has a very large market in the United States. Finally, reinforced thermoplastic pipes (RTP), ideal for sectors such as Oil & Gas, are products in which strong interest is growing.



Massimiliano Fenili is on the right

**In light of the above, which technological innovations will the expansion of the Bausano tube division focus on?**

*Fenili:* First of all, the R&D Area will be engaged in expanding the range of extrusion lines for pipes with a diameter of up to 1200 mm. The main purpose is that of supporting customers in achieving their own goals, by defining the correct setup of machines with the consequent collection of data and the related definition of production KPI. Within this context, digitisation and Industry 4.0 play an essential role. The development of the Orquestra software, a centralised control system which allows continuous and real-time monitoring of performance, even in terms of predictive maintenance, by guaranteeing increasingly high levels of efficiency is an example of how Bausano is responding to these new needs. These levels, in turn, are aligned in terms of sustainability which, in its several forms, plays an increasingly central role, of which Bausano is already a precursor. An example is the Smart Energy System, the induction cylinder heating system, thanks to which it is possible to limit the wear of the machinery and to achieve energy savings of 35%. Furthermore, the company invests on the reduction of production waste: by equipping its extruders with advanced technologies and, on the other hand, by developing extrusion lines capable of regenerating in-house industrial residues or post-consumer household waste.

**What are Bausano's long-term goals?**

*Fenili:* The team I join is heterogeneous, dynamic and characterised by consolidated experiences and transversal skills. An essential aspect in order to ensure strong integration between the various departments and encourage product and process innovation. At the same time, this allows us to offer customers a very high level pre and post sales consultancy. Finally, the Team will be in charge of coordinating R&D activities, in compliance with Bausano's strategic lines of development and growth in new markets, such as the United States.

► Bausano & Figli Spa

C.so Indipendenza 111, 10086 Rivarolo Canavese (TO), Italy  
www.bausano.com



# A FEEDER THAT FITS SEAMLESSLY INTO YOUR PRODUCTION LINE WITHOUT CUSTOMIZATION?

THIS ONE WILL.

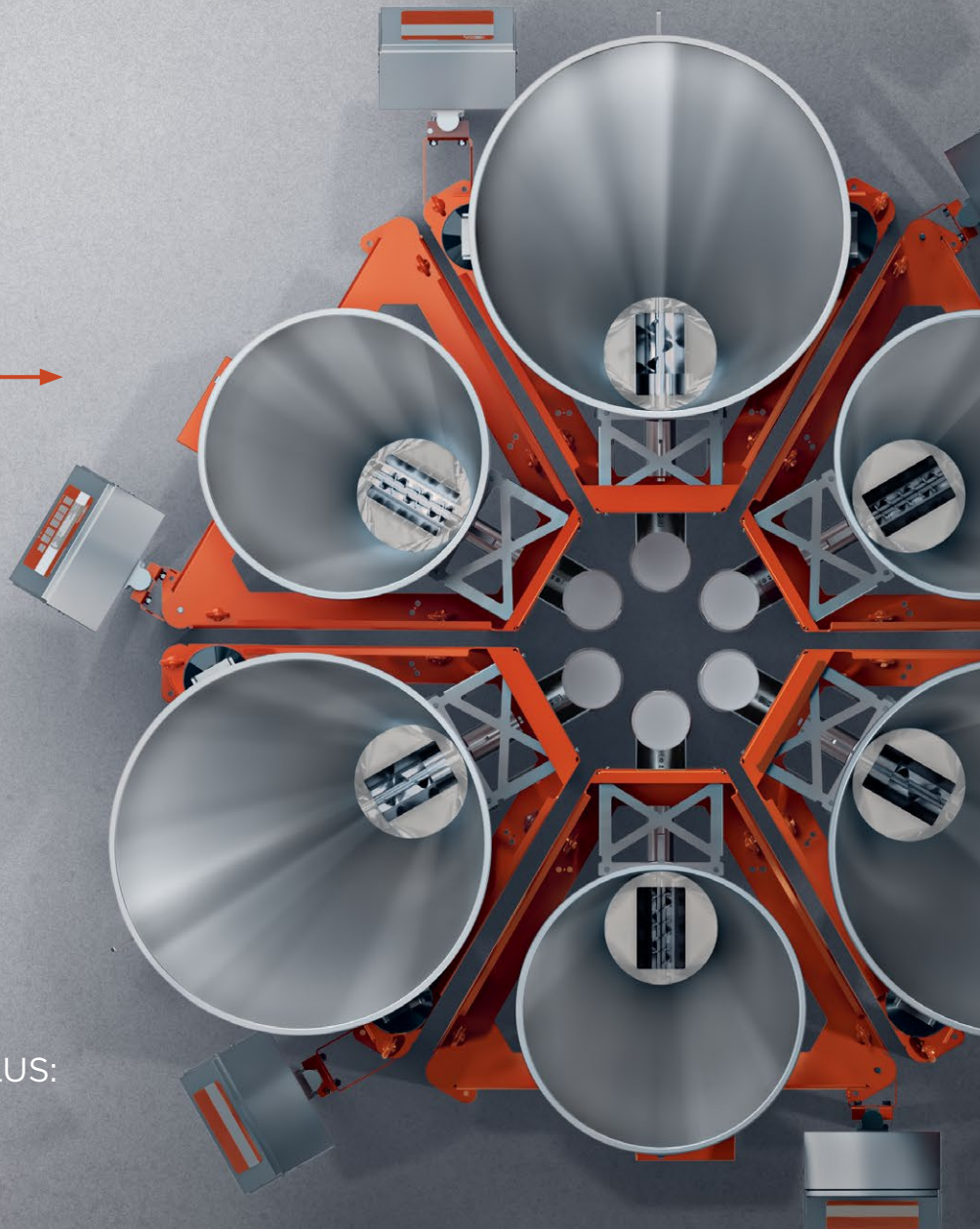
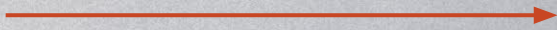

THE ALL-NEW PRORATE PLUS:  
SURPRISINGLY POWERFUL

[www.prorate.plus](http://www.prorate.plus)



# CENTERWAVE 6000 – Now Also for Pipes up to 1,200 mm Diameter

*SIKORA offers the CENTERWAVE 6000 for the measurement of wall thickness, inner profile and diameter as well as ovality of plastic pipes. Now a new model is available, which specifically covers diameter ranges from 250 to 1,200 mm [10 to 48"]. The CENTERWAVE 6000/1200 thus specifically meets the requirements of large pipe manufacturers.*

The new model's compact design makes it easy to integrate into production and makes it particularly suitable for extrusion lines producing pipe diameters of up to 1,000 and 1,200 mm [39.4 and 48"]. In-line, the system supports immediate centering and reliable quality control. For the American market, the new model also covers the common 48" IPS and DIPS standard.

Small pipes from 60 mm [2.3"] as well as large pipes up to 3,200 mm [126.0"] diameter – all models of the CENTERWAVE 6000 device series are characterized by their innovative measuring principle based on millimeter wave technology. Operation is intuitive at the push of a button. Once switched on, the operator immediately receives continuous and precise measured values – without presetting the product parameters and without any calibration.

*The CENTERWAVE 6000 from SIKORA*

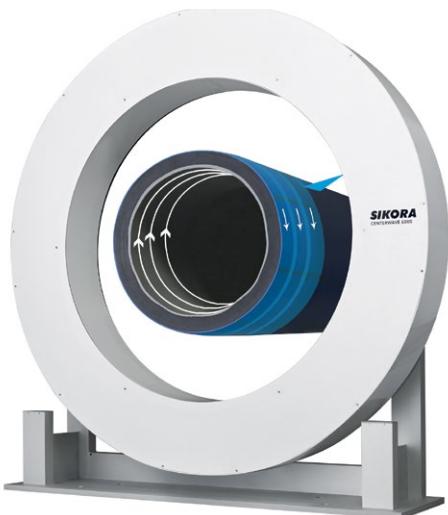

The CENTERWAVE 6000 is equipped with a transceiver that rotates permanently. Due to the rotation speed and the line speed running parallel to it, the measurement takes place in the form of a helix structure in the direction of production, ensuring 100 % coverage. In this way, the wall thickness, diameter and inner profile are recorded without gaps both over the entire circumference and in the longitudinal direction of the pipe, and min. and max. values are reliably determined. With each rotation, the measuring spot overlaps. Thus, the inner contour of the pipe is precisely mapped and abnormalities such as sagging are immediately detected so that countermeasures can be initiated at an early stage.

In addition to measuring all relevant pipe parameters, the CENTERWAVE 6000 also offers automatic control of the extrusion line taking into account the standard deviation. This avoids over-consumption as far as possible and achieves a higher degree of automation of existing plants. This enables an amortization of significantly less than one year.

According to the physical law "angle of incidence equals angle of exit", only the measured values that are at 90 degrees to the sensor are directly reflected. All other beams are deflected more strongly and no longer reach the sensor. In systems with static sensors, this results in gaps between the individual fixed measuring points, which – depending on the number of sensors installed – vary in size and thus prevent an exact determination of the minimum wall thickness. In systems



*The measuring data of the CENTERWAVE 6000 are clearly displayed*

with rotating sensors, on the other hand, the millimeter waves always strike the measured object at a 90 degree angle and are reflected directly. This creates the prerequisite for a gapless, 360-degree measurement over the entire pipe circumference.

SIKORA AG  
Bruchweide 2, 28307 Bremen, Germany  
[www.sikora.net](http://www.sikora.net)

K 2022: Hall 10, Stand F14



# Presence in Italian Market Strengthened with Top Technology Solutions

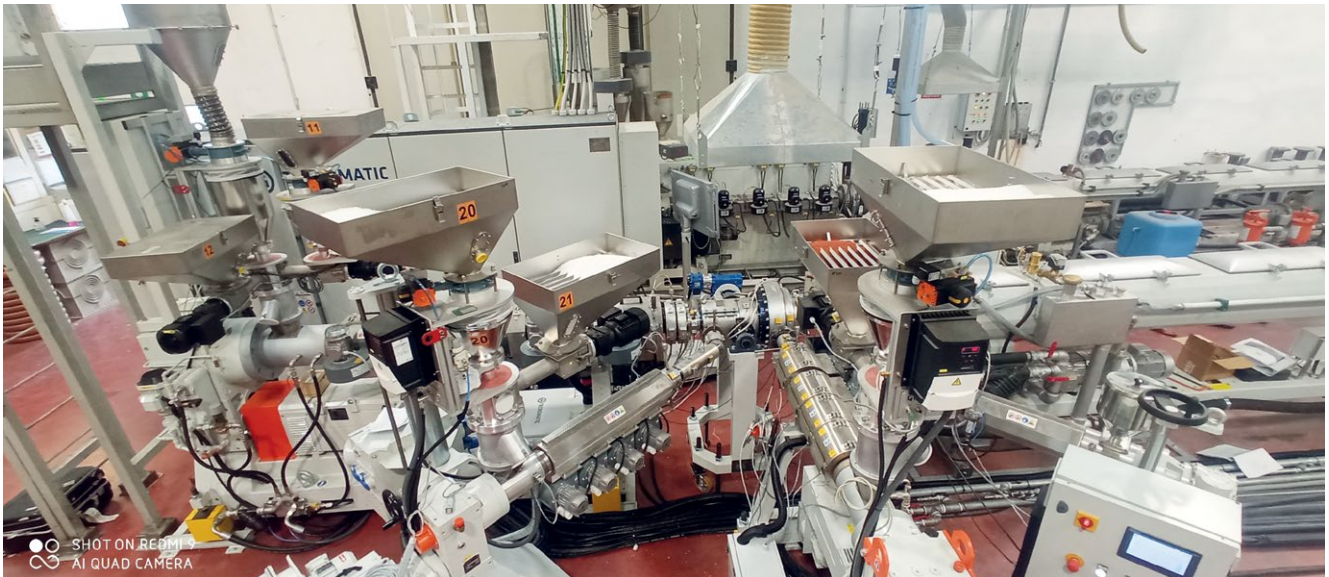

*Tecnomatic increases its presence in the Italian market with the agreement to supply a new line for multilayer polyethylene to the company Riccini, an historical company in the panorama of the production of Italian plastic pipes which started in 1970, and well known for the excellent quality level of its products.*

In order to guarantee the production of quality multilayer pipes, with range from  $\varnothing$  20 to 90 mm, and output up to 600 kg/h, Tecnomatic relied on long-tested technical solutions, such as VEGA extruders in L/D 37 ratio, co-extruders for the inner and outer layer in L/D 30 and die head VENUS MULTI 160 from the Venus Multi series produced for diameters up to 1,600 mm.

The extruders and the line are controlled by the new EPC II (Extrusion Process Control), a modern PLC with an intuitive touch screen panel that integrates and centralizes all the parameters of the entire extrusion process. In the digitalization and so-called "smart factories" era, the line could not do without the latest development of Tecnomatic to assist pipe manufacturers with an integrated system of solutions, software, and automation. PIPE 4.0 is an easy-to-use program for networking pipe extrusion lines. Through the machine's EPC (Extrusion Process Control) system, different machines and peripherals are connected to each other to be activated through a uniform user interface, which allows interaction between individual devices. In this way, the whole production process, including material feeding, temperature control and synchronization, is coordinated and monitored. Another

important point is that all parameters are recorded and monitored centrally.

To complete the line, a pipe breaking detection system with optical technology and a gravimetric dosing system on each extruder were a must-have, for a total of seven components. The system, integrated into the main control panel, guarantees a constant advance of the raw material, and records the variations in mass flow rate, thus ensuring a perfect weight/meter and distribution of the thickness of the walls control. The downstream equipment includes Tecnomatic vacuum and cooling tanks, haul-off with cat-erpillars individually controlled by vector AC motors, and a planetary cutter with knife cutting and universal clamps, for precise cutting without pipe chips.

Tecnomatic is extremely proud to be Riccini's supplier for this last project, which highlights how quality partners and excellent teamwork are the only way to keep innovating in the plastic pipe industry.

► Tecnomatic S.r.l.

Via Emilia, 4, 24052 Azzano San Paolo BG, Italy

<https://tecnomaticsrl.net/>

# Achieving Sustainability Targets by Digital Means

## A Holistic Approach to Identifying Solutions for Improved Recyclate Use

*As part of the European Green Deal, an international shift to a circular economy is being promoted at EU level. This involves, among other things, setting the course to reduce environmental damage caused by emissions, making sustainable use of finite resources, and enabling the recycling and reuse of as many materials as possible. The recycling-friendly optimisation of products and processes – also in plastics processing – is essential for achieving these European targets. The complex and varying composition of recyclate material, in combination with the lack of evaluation standards, is creating obstacles against its industrial use. In addition, regulatory restrictions can frequently not be fulfilled. Finally, there is a lack of information along the process chain of plastics products that is needed to guarantee ecological and sustainable optimisation.*

The level of contamination and, in this connection, also the product design has a key influence on the recyclate properties. Packaging often consists of several components, for example from different plastics as well as additives, printing inks or adhesives. Apart from that, recyclate material has experienced various types of stress during its utilisation and processing. This leads to different levels and types of damage to the material, and affects the properties of the products in later use. The uncertainty about the origin and composition of the recycled plastic material also makes it difficult to define its characteristics and to determine the data that are important for meeting the regulatory requirements and for its processing. IKV has, since the 1980s, been working on solutions to numerous questions in this area of research.

### Digital approaches promote closed loop recycling

Especially in combination with digital innovations, such research results have the potential to solve these challeng-



*R-Cycle pilot project - Identifiable and fully recyclable all-PE pouches (Picture: R-Cycle)*

es, and are regarded as a driving force when it comes to raising recycling quotas and promoting the circular economy in the field of plastics. In this connection, data platforms are of elementary importance for increasing the general exchange of information, for tracking material flows and for documenting sustainability data on raw materials and products. By exchanging the collected sustainability data, it is possible to document the effects exerted by the design and the process, to draw up transparent and accurate life cycle assessments, and to align the recycling of plastic waste. The development and implementation of such approaches – aimed at increasing the real recyclate application quotas – requires the involvement of all players in the plastics industry.



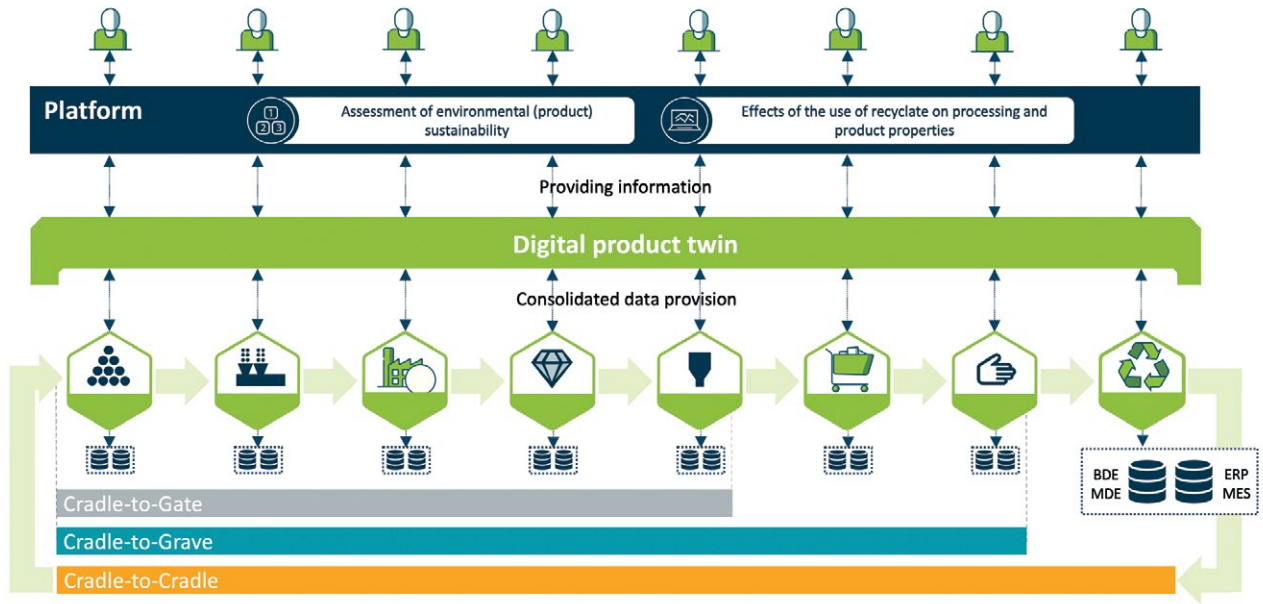

IKV is pursuing a holistic approach to identify digital solutions for the improved use of recycle. In the PlasticBOND research project, together with a broadly based industry consortium, prototype concepts are being developed that consider the product and process properties at every stage of the life cycle, and make the information available as a set of data in line with the material passport introduced by the Industry 4.0 platform. Applications in which the digital passport can provide a benefit are, in addition to more efficient processing, also the holistic optimisation of the ecological sustainability (e.g. the CO<sub>2</sub> footprint of packaging) or the compliance with the Extended Producer Responsibility (EPR). Here, IKV makes use in particular of the experience acquired in the R-Cycle project with traceable plastic products.

Alongside this, a study is also being carried out of the effects on processing of using varying recycle qualities and varying recycle contents, as well as their influence on the respective process control. The focus of the project is less

*PlasticBOND - Schematic illustration of the platform design to be developed*

on raising the individual recycle quality or optimising the actual processing, but more on improving the standards for recycle. This should then make it possible, taking into account the complexity of the reprocessing, to make specific use of recycle according to the classification, and thus turn the "circular economy" from a political goal to a practicable, everyday technology.

► Institute of Plastics Processing in Industry and Craft at RWTH Aachen University (IKV)  
 Seffenter Weg 201, 52074 Aachen, Germany  
 Malte Schön, M.Sc.  
 Head of department Extrusion and Rubber Technology  
 +49 241 80-28372, malte.schoen@ikv.rwth-aachen.de

# SMART EXTRUSION

A SPECIALIZED WEB PORTAL

- ▶ News about relevant products and events
- ▶ Detailed reviews of various smart technologies
- ▶ Case studies from processors
- ▶ English, German, Russian and Chinese

- ▶ Video clips demonstrating smart equipment in live action
- ▶ Latest magazines available for reading and downloading
- ▶ Weekly e-mail newsletters

[www.smart-extrusion.com](http://www.smart-extrusion.com)

# Innovative ZS-B MEGAfeed Side Feeder Makes Plastics Recycling Markedly More Economical

*With the goal of making recycling of lightweight, high-volume fiber and flake recyclate much more economical and, in some cases even possible, Coperion has developed a new version of its ZS-B side feeder. Using the innovative ZS-B MEGAfeed, plastic recyclate with a bulk density under 200 kg/m<sup>3</sup>, long considered intake-limited and thus not worth recycling, can be reliably fed in large quantities into Coperion's ZSK twin screw extruder and be concurrently recycled and compounded.*

The ZS-B side feeder's novel design makes it possible to feed very high rates of fiber and flakes, such as PA, PE, PET, and PP. As a result, the ZSK twin screw extruder's high capacity can be fully exploited when the ZS-B MEGAfeed is used. Very high throughputs in both mechanical and chemical recycling of post-industrial and post-consumer waste are achieved.

## Increased Throughput in Numbers

With a ZSK 58 Mc18 twin screw extruder, the throughput increase and thus the potential of the new ZS-B MEGAfeed becomes very clear. When recycling PA fibers with a bulk density of ~40-50 kg/m<sup>3</sup>, throughputs of 70 kg/h were previously achieved using conventional equipment. When the PA fibers were fed into the ZSK extruder using the ZS-B MEGAfeed, throughputs increased about fourteenfold to 1,000 kg/h. Similar results were achieved recycling carbon fibers with a bulk density of ~50-70 kg/m<sup>3</sup>; in this case, throughputs increased from 50 kg/h to 2,500 kg/h using the ZS-B MEGAfeed. When recycling PCR (Post-Consumer Recycled) flakes, throughputs increased from 50 kg/h to 700 kg/h, and from 80 kg/h to 1,300 kg/h with multilayer film flakes.

## Key to Economical Recycling of A Wide Variety of Plastics

Plastics previously considered not recyclable are becoming a valuable raw material using the new Co-

perion ZS-B MEGAfeed. For example, PCR flakes or recyclate from carbon fiber-reinforced plastics can now be fed into the ZSK extruder at high feed rates and recycled economically.

In the case of mechanical upcycling, upstream processes necessary for compounding, such as compacting, melting and agglomeration, are completely eliminated using the ZS-B MEGAfeed technology. In this recycling process, flakes and fibers can be fed directly into the ZSK extruder, where they are melted, compounded, devolatilized, and filtered in a single step. In so doing, both investment costs and energy consumption drop. The production process becomes significantly more efficient. Moreover, the thermal product stress is reduced and recyclate quality increases.

Even when recycling PET, the feed rate is no longer a limiting factor. With the ZS-B MEGAfeed, PET flakes and fibers can be fed into the ZSK twin

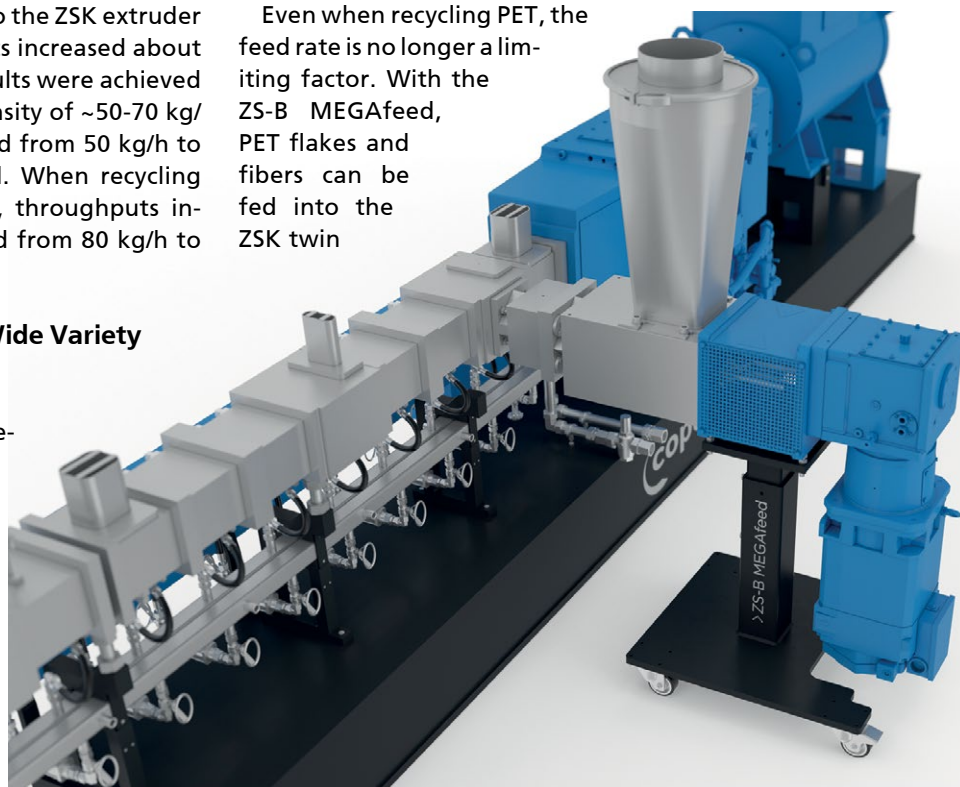

*The new ZS-B MEGAfeed side feeder from Coperion significantly increases fiber and flake feed rate into the ZSK twin screw extruder, making many plastics recycling processes markedly more economical, and making some possible that had not been before (Photos: Coperion, Stuttgart Germany)*



**THROUGHPUT COMPARISON – WITH AND WITHOUT ZS-B MEGAfeed SIDE FEEDER**  
(data from a Coperion ZSK 58 Mc<sup>18</sup> twin screw extruder)

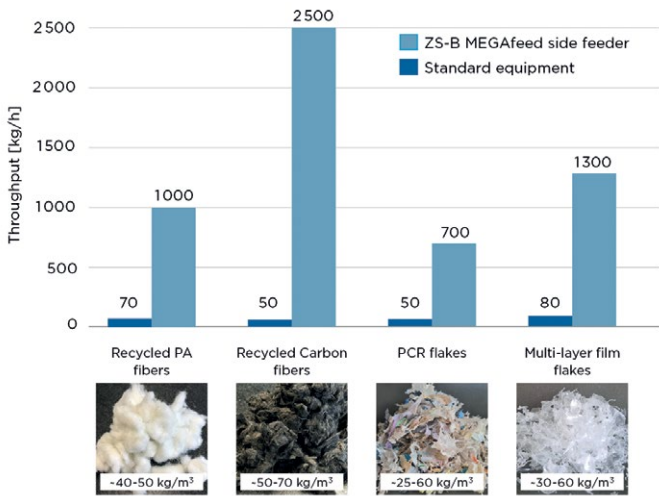

*The significantly improved plastic fiber and flake feed rate using the ZS-B MEGAfeed side feeder leads to enormous throughput increases when recycling plastics with a Coperion ZSK twin screw extruder*

screw extruder in large quantities with no pre-drying or crystallizing, where they can be processed with the highest degree of profitability.

The ZS-B MEGAfeed can also feed large quantities of post-consumer waste, adding appreciable value to the chemical recycling process with the ZSKs. ZSK throughput rates are very high with the ZS-B MEGAfeed. Preheating of the recyclate via mechanical energy input of the twin screws thus becomes even more economical for further processing in the reactor.

Existing Coperion extruders can be retrofitted with ZS-B MEGAfeed technology to greatly expand their spectrum of applications and increase their throughput rates.

Marina Matta, Team Leader of Process Technology Engineering Plastics at Coperion, is enthusiastic about the latest Coperion development: "We're convinced that the new ZS-B MEGAfeed will play a pioneering role in plastics recycling. In particular, plastic fibers, which will be available in ever increasing quantities from textiles, had always been considered hardly recyclable until now. With the ZS-B MEGAfeed, this is now possible. Far more plastic waste can be recycled – and much more efficiently. For the plastics industry, the ZS-B MEGAfeed is another step forward on the path to a circular economy, and we are very proud of that."



**2022** 19-26 Oct  
Düsseldorf Germany  
**Hall 8b F11-4**

# FOCUS

## SCREW | BARREL | SHAFT



**Nanjing Lesun Screw Co.,Ltd.**

E: info@lesunscrew.com  
www.lesunscrew.com

# Bundled Expertise for the Production of Alternative Polyolefin-Based Floor Coverings

*In cooperation with ExxonMobil and additional development partners, KraussMaffei has successfully completed the in-house project for the production of alternative PP-based floor coverings in its R & D center in Hannover, Germany. "Polyolefin-based floor coverings offer a range of benefits that make them extremely popular," says Janina Roesch, Product & Application Owner Flat and Foam at KraussMaffei. "With our development project we invest in this growing market and support manufacturers in overcoming market entry barriers."*

## Laboratory line scores with outstanding flexibility in product development

"Our laboratory line offers unparalleled flexibility in terms of the formulations we can use and floor covering dimensions," emphasizes Janina Roesch. These floor coverings can be produced from virgin or recycled PP material and their mechanical properties can be optimized adding various fillers like calcium carbonate or talc as well as by incorporating fibers. The plant configuration is suitable for both, thin and extremely flexible

*ZE BluePower twin-screw extruder with slot die for the cost-effective production of PP floor coverings*

floorings with a thickness of 2.5 mm as well as for thick and rigid sheets with thicknesses of up to 6 mm. The wide variety of potential products is ensured by the in-line compounding system and the adjustable polishing calender designed as PlanetCalender.

## Key components: in-line compounder and PlanetCalender

For the cost-effective production of the new PP floor coverings KraussMaffei uses a ZE BluePower twin-screw extruder that provides a large process

window for optimum final product quality even with varying properties of the input material. Thanks to its large free volume and high specific torque, this type of extruder allows unparalleled output capacities to be obtained. Several metering stations and side feeders are arranged along the processing section for in-line feeding of solid and liquid additives to achieve maximum filler loading of the final product without requiring any previous compounding. The material is guided from the slot die to the PlanetCalender that is equipped with adjustable rolls to ensure perfect polishing of floor coverings of any dimension.

The extruded sheets can either be coated with a laminated decorative film and wear protection film in an in-line process or have a decor printed on them in an off-line process, which then requires additional sealing.

## Formulation development in cooperation with ExxonMobil

During formulation development, highly flexible Vistamaxx™ polyolefin elastomers proved extremely advantageous as they allow a high filler and reclaim share to be incorpo-

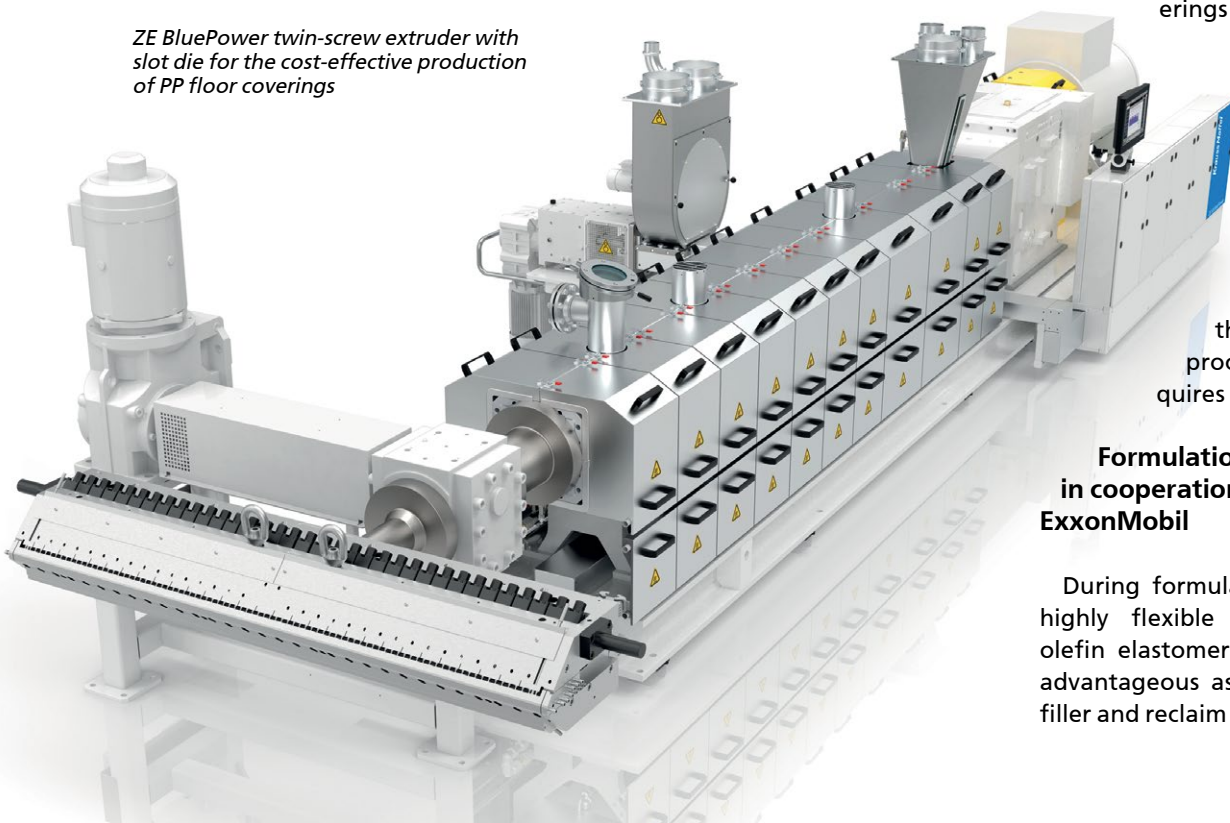



*PP floor coverings – favourably priced, very robust, easy to lay and to clean, warm to the feet and available in many attractive designs*



rated, which ensures impact strength and adhesion of the top layer. "We contributed our extensive technological know-how and our wide portfolio of polyolefin elastomers to develop innovative, customized floor covering formulations that can be manufactured and tested efficiently on the KraussMaffei pilot line," says Gertrud Masure, Market Development Manager, EMEAF, Polypropylene, Vistamaxx™ and Adhesion at ExxonMobil. In the future, the jointly developed baseline formulation can be adapted to specific requirements of interested customers and will offer them ideal prerequisites for success in this fast-growing floor covering market segment.

"We look forward to cooperating with potential customers wishing to test their individual formulations on the line installed in our R & D center," emphasizes Janina Roesch.

"As we are deeply convinced that PP floor coverings will continue to gain popularity in the coming years, we aim at providing producers an innovative platform for the development of ground-breaking floor covering solutions."

➔ KraussMaffei Extrusion GmbH  
An der Breiten Wiese 3-5, 30625  
Hannover, Germany  
[www.kraussmaffei.com](http://www.kraussmaffei.com)

# SMART EXTRUSION

The only website collecting information about smart technologies of extrusion

**34 600 + average monthly visits**

Geographic distribution of Smart\_Extrusion readers, %

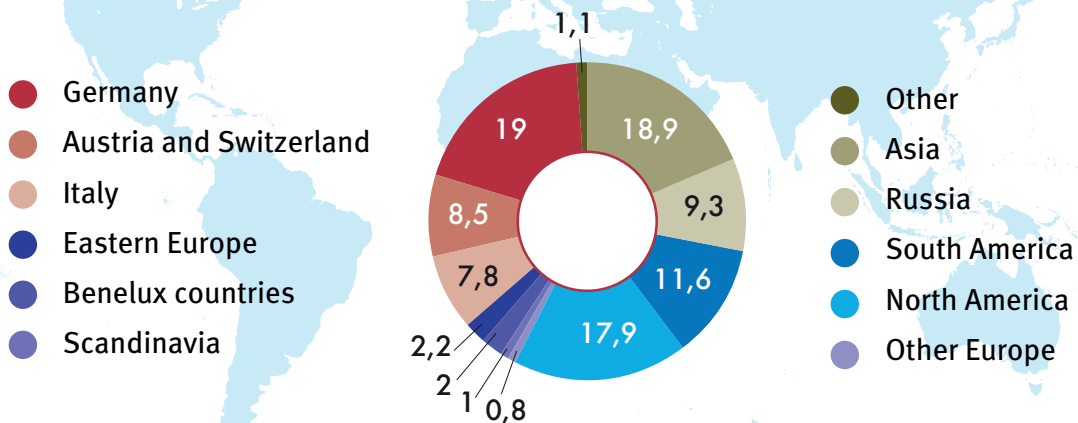

[www.smart-extrusion.com](http://www.smart-extrusion.com)

# Belling Machine Forms Rieber Socket in PVC-O Pipes

*SICA, a manufacturer of plastic pipe processing machinery, has developed an innovative Rieber belling process, specific for PVC-O pipes (oriented molecule PVC pipes). At the same operating pressure, these pipes require a wall thickness of about 35 to 40% less than those in PVC-U and allow the construction of water supply pipes up to 25 bar of operating pressure. Because of these and other advantages, PVC-O piping systems are becoming increasingly popular.*

Like PVC-U pipes, the PVC-O pipes are joined in a socket. The socket, including the gasket seat, is made in an extrusion line with a special belling machine.

In PVC-U pipes, "Anger" type sockets are used, i.e. with removable and replaceable gaskets, as well as "Rieber" type sockets that have a gasket already integrated in the belling phase and not removable during the assembly of the pipeline. The Rieber system is popular because during installation the possibility of accidental displacement of the gasket is reduced and the risks of external water dispersion are lower.

The realization of the socket in PVC-O pipe requires different procedures than the conventional ones for PVC-U pipes. Up to now, these specific procedures have proved to be industrially applicable only for forming Anger-type sockets. The absence of the Rieber socket joint in the PVC-O piping sector has excluded its application where the Rieber socket is considered decisive for the operating conditions for laying the pipelines.

The innovative and exclusive SICA Rieber belling process for PVC-O pipes changes the scenario and makes the Rieber system possible on belling machines used in bioriented pipe production plants. In fact, the belling machines are able to process both pipes produced and oriented continuously in the extrusion line,



*PVC-O pipe DN315 PN25 ISO 16422 MRS500 with Rieber socket with SICA process*

but also pipes oriented off-line in a tank. The Rieber SICA belling system is functional in PVC-O pipes that comply with all the following technical standards:

- European EN 17176
- American ANSI / AWWA C909 and ASTM F1483
- Australian AS / NZS 4441
- Canadians CAN / CSA-B137
- International ISO 16422

It is significant that, as with the well-established SICA Starbell belling machines used for making Anger sockets, the innovative SICA procedure is applied to pipes up to the maximum

molecular orientation required by the standards, including class 500 established by ISO 16422; a standard that, among all those indicated, imposes the most stringent requirements for resistance to hydrostatic pressure in PVC-O piping systems.

The SICA belling machines that implement the Rieber belling process are available in three models based on the dimensions range of the machinable pipe.

➔ SICA S.p.A.  
[www.sica-italy.com](http://www.sica-italy.com)



# EXTRUSION

EXPERT MAGAZINE ON PLASTICS EXTRUSION

The only technical magazine worldwide exclusively for the sectors:

- Material Preparation
- Compounding
- Extrusion
- Recycling
- Calendering
- Thermoforming
- Welding
- Finishing of Plastics and Elastomers



**Extrusion** (German)

**Extrusion International** (English)

**Extrusion International USA** (English)

**Extrusion Russia Edition** (Russian)

**Extrusion Asia Edition** (Mandarin/English)

The only plastics trade magazine for Asia, published from Germany

8 issues a year

6 issues a year

6 issues a year

4 issues a year

2 issues a year

**SMART  
EXTRUSION**

All editions available for free:  
[www.smart-extrusion.com](http://www.smart-extrusion.com)

**VM Verlag GmbH** Cologne/Germany





## Web conference

December 8, 2022 • Start: 10.00 CET

[lab.extrusion-info.com](http://lab.extrusion-info.com)

The official language  
of the conference is English

# Laboratory & quality control in plastics processing

- laboratory equipment
- quality control of input raw materials
- quality control of finished products
- analytical equipment
- measuring equipment
- pilot and test lines
- desktop mini IMM and mini extruders
- laboratory mixers and compounders
- laboratory and processing simulation software
- metrology and equipment verification
- laboratory analysis services
- formulation development services
- certification services
- external engineering and research services
- R&D in the enterprise

Developed by:

**VM VERLAG**  
Cologne/Germany

**EXTRUSION**

**EXTRUSION**  
INTERNATIONAL  
WORLDWIDE

**ЭКСТРУЗИЯ**  
EXTRUSION RUSSIAN EDITION

**挤塑 EXTRUSION**  
ASIA EDITION

**smart.molding**  
international



Contact: Alla Kravets • Tel.: +49 2233 949 87 93 • [a.kravets@vm-verlag.com](mailto:a.kravets@vm-verlag.com)