

05/2020

VVA VERLAG  
Cologne /Germany

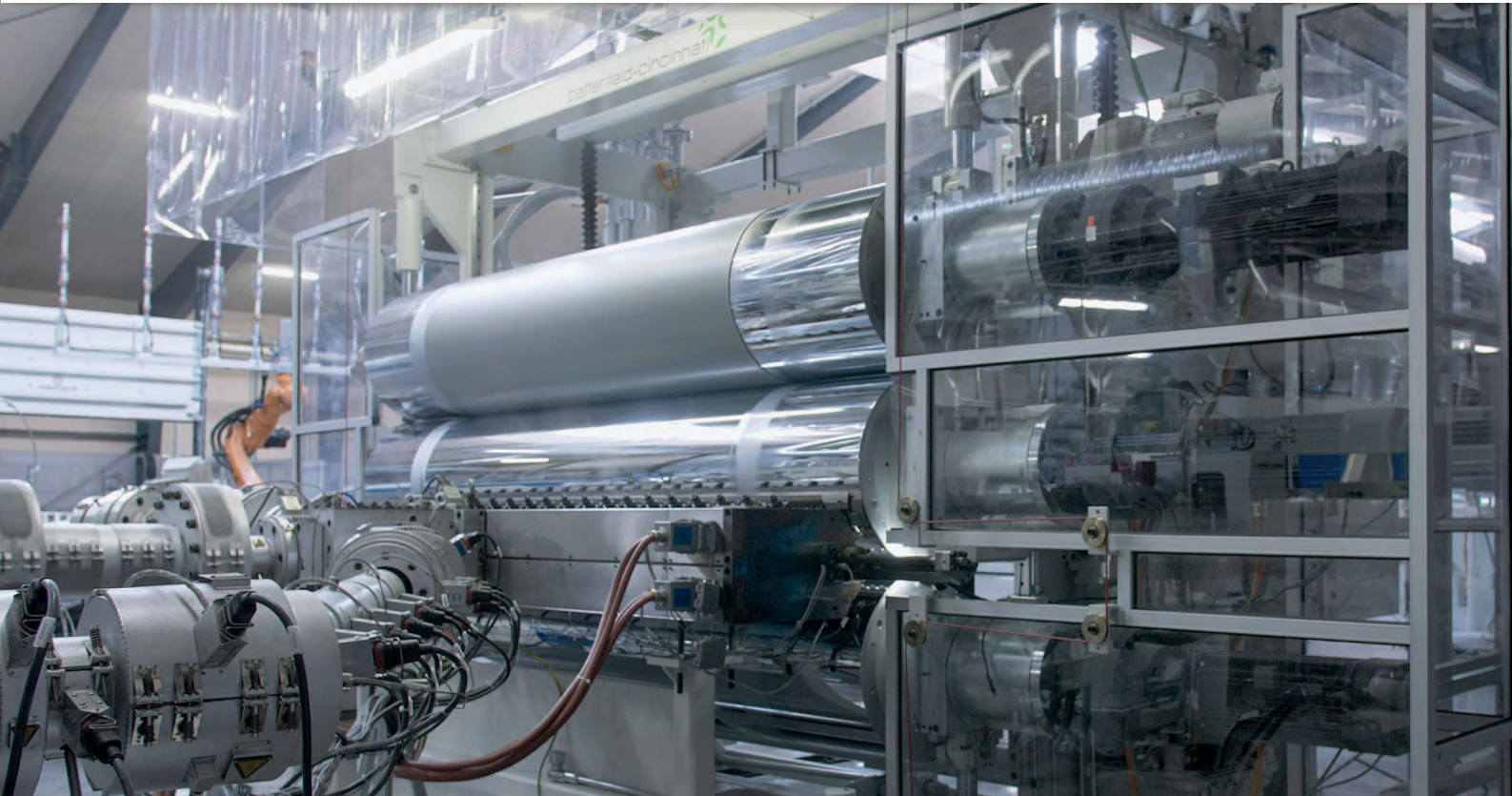

# EXTRUSION INTERNATIONAL



battenfeld-cincinnati 

Process engineering for  
efficient plastics extrusion  
of tomorrow.





## 20 Year Profile Guillotines made by Stein Maschinenbau - a continuously development

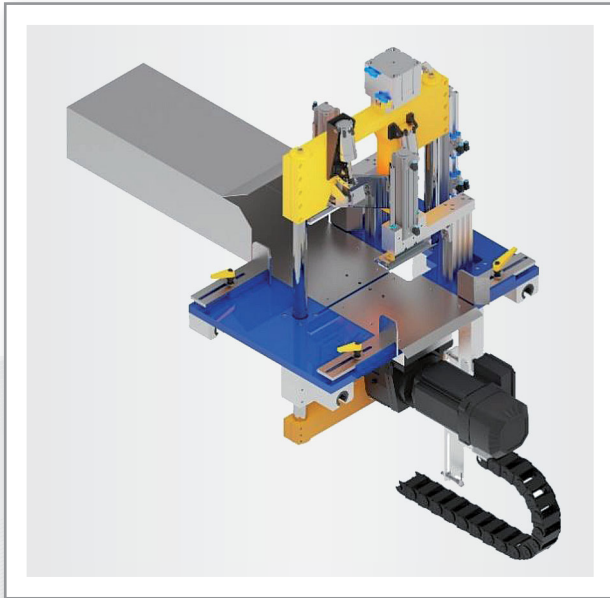

### PT1 Profile Guillotine

- solid design
- high cutting quality
- many hundreds times in operation

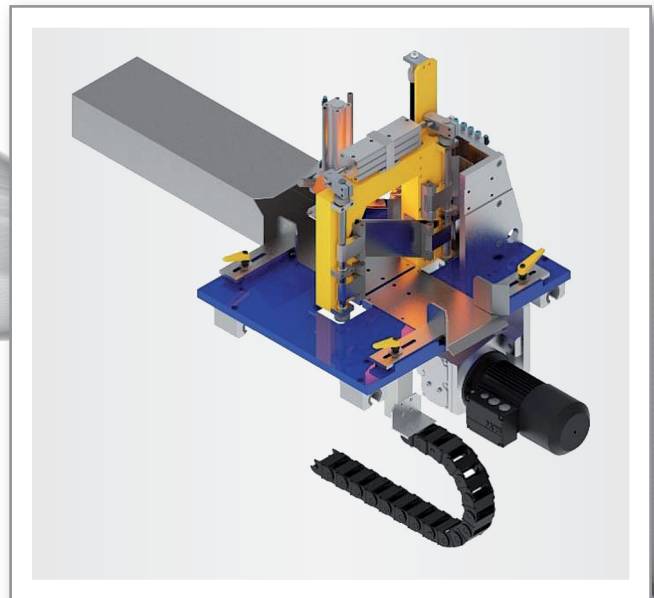

### PTW Profile Guillotine

- 2 cutting angles selectable
- optimum cut with different profile orientations

**NEW**



### PTT Profile Guillotine

- cutting angle continuously adjustable
- optimum cut for every profile shape

In addition to the guillotines shown, numerous customer-specific solutions have already been implemented.

**Challenge us!**



Made in  
Germany

## Profile Guillotines made by Stein - fits to every system of profile extrusion

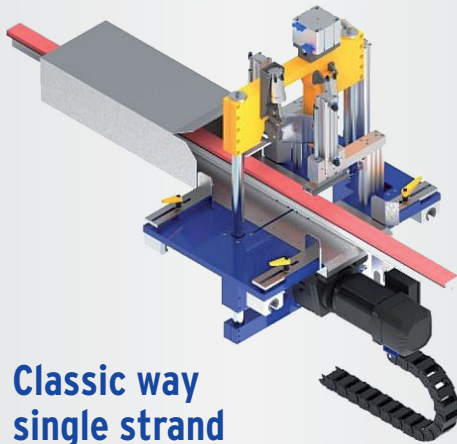

Classic way  
single strand

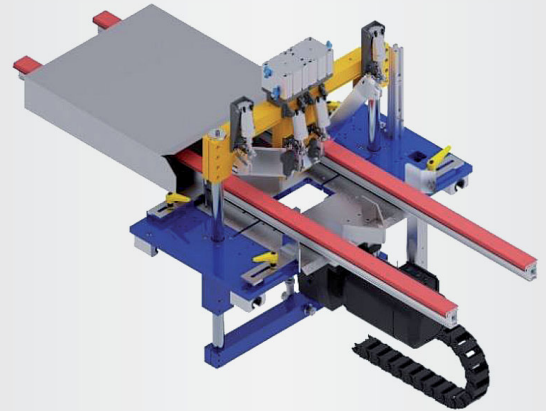

double strand or dual strand

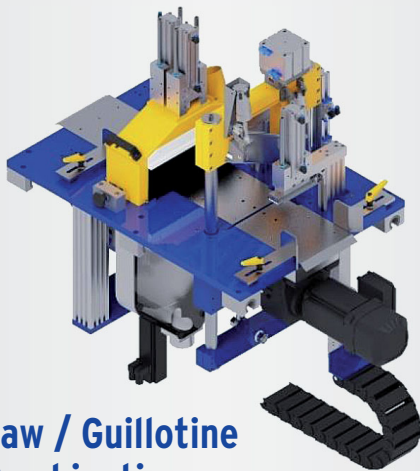

Saw / Guillotine  
Combination

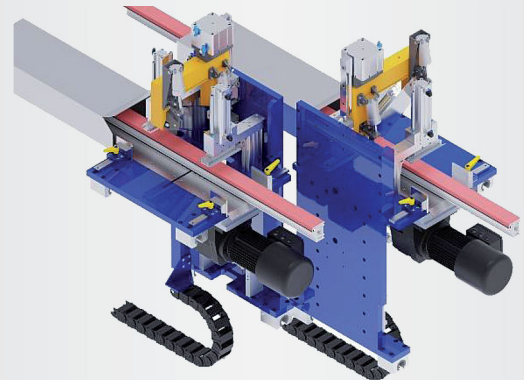

- Are different material or different profile designs made on same line?
- Saw / Guillotine Combination will cover it

**Next step Smart Factory!**

**Equip your line with machines made by Stein!**



**STEIN Maschinenbau  
GmbH & Co. KG**

Wartbachstr. 9  
D-66999 Hinterweidenthal/Germany  
Tel. +49/63 96/92 15-0  
Fax +49/63 96/92 15-25  
stein@stein-maschinenbau.de  
www.stein-maschinenbau.de

Firms in this issue	6	Remote Commissioning and Modernization	20
Imprint	7	Bioplastics with Variable End-of-Life Options	20
<b>Industry News</b>	8	Keeping Plastic Compounds Free of Metallic Contaminants	21
Calendar	8	Compact Solution for Small Conveying Systems	22
Industry and Associations stand by Trade Fair Dates: wire and Tube will be held	8	Distribution Partnership for Mexico Entered	22
PLASTIMAGEN Mexico Announces its Next Edition	9	In-House Rheology Lab Launched	23
Activities in the European Plastics Market Booted	9	<b>Extrusion Technologies – Case Study</b>	
NPE2021	10	High-Speed Production Line for „Danish Trays“	24
Company Anniversary	10	<b>Pipe Extrusion</b>	
Change of Leadership	11	Innovation and Enhanced Performance in the Production of Multilayer Pipes	26
Foundation Stone for New Company Premises	12	<b>Film Extrusion, Materials</b>	
Majority Stake in Norwegian Machine Trading Company Acquired	12	Cooperations for a Sustainable Future – BOPE is at the Head of the List	28
Interplastica sends Important Signal in Difficult Times	13	<b>Compounding</b>	
Market Study: Masterbatches – World	14	Innovation and Enhanced Performance in the Production of Multilayer Pipes	30
New Regional Sales Manager in South Asia	14	<b>Blown Film Extrusion</b>	
General Sales Manager in Asia Appointed	15	Advantageous Production of Full PO Films	31
Acquisition	15	<b>Recycling</b>	
Extrusion Drying	16	PET Fiber Production – Zero-Waste Cycle Thanks to Retrofitted Components	32
Tackifier Capacity Expansion in China Announced	16	<b>Extrusion Blown Film</b>	
Software Tools against Covid-19	17	Producing High Quality Film from Low Cost Biodegradable Raw	34
„Energy-light“ Drive System at wire & Tube 2020	18	<b>Materials</b>	
Integration Completed	18	Noryl PPX Polymeric Blend and Natural Polypropene	36
Extrusion Tooling	19		



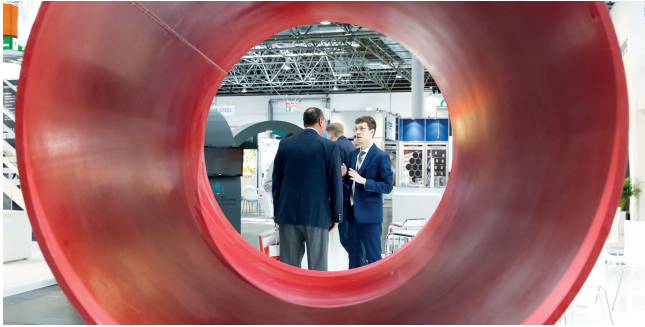

**8** Messe Düsseldorf creates all the requirements for holding successful and hygiene-conforming trade fairs in COVID-19 times. The European umbrella organisations as well as major companies of the leading international trade fairs wire and Tube clearly speak out in favour of the trade fair dates from 7 to 11 December 2020 at Düsseldorf Fairgrounds

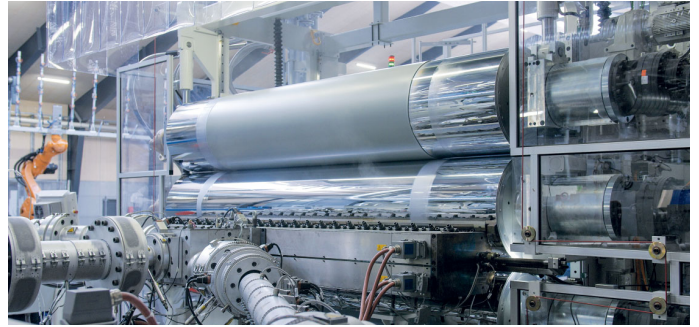

In the production halls of the Danish company **24** Staal og Plast stand the world's largest thermoforming line. To produce the up to 8 m long and 2.5 m wide semi-finished boards, battenfeld-cincinnati Germany installed an ultra-modern sheet extrusion line



In this article will be showcased how **26** Tecnomatic, a leading manufacturer of processing equipment for polyolefin and PVC pipes continues to improve the technology and performance for the production of complex multilayer pipes with functional layers

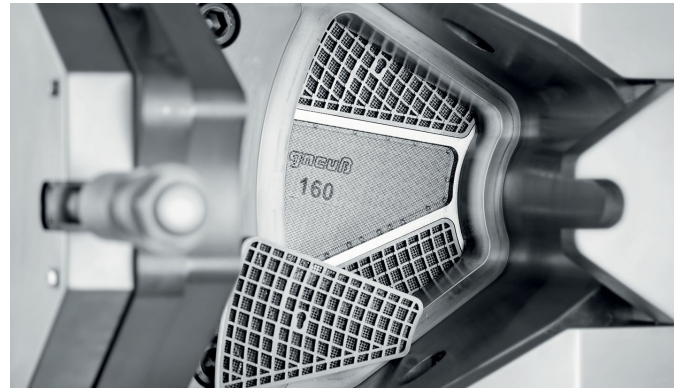

For ecological and economic reasons, fiber **32** residues must be appropriately processed and reused, which in some cases poses major challenges for fiber manufacturers and processors. Several customers have therefore decided to use key components from Gneuss Kunststofftechnik

Buss AG inaugurated the first kneader **30** test center in 1948 and delivered the first compounding systems for PVC and polystyrene in 1950. The company subsequently established this technology globally as the system of choice for producing compounds both efficiently and particularly gently



Guill Tool has opened an in-house **23** rheology laboratory, making it the only extrusion tooling manufacturer in the industry with such a capability

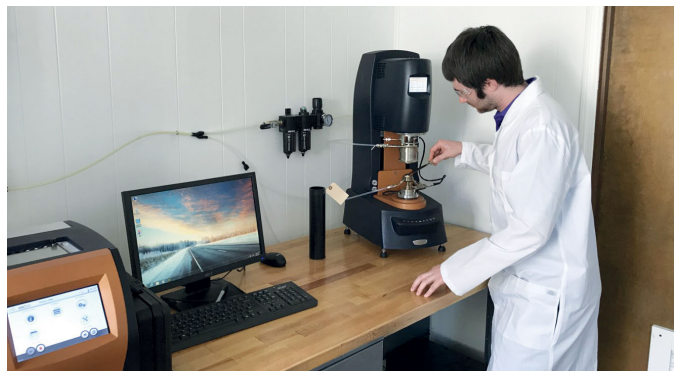

## Index of Advertisers, companies and *fairs* referred in this issue

Air Control Industries	16	Kuhne	31
ALEKO	34+35	Loparex	18
battenfeld-cincinnati	Outside Cover, 24	Maag	15
BIO-FED	20	Messe Düsseldorf	8, 11
Brückner	28	motan-colortronic	15
BUSS	30	motan Gruppe	22
Cabot	29	Nordson Polymer Processing	14, 15
CCA	17	NPE2021	10
Ceresana	14	Pixargus	9
Coperion	20	PLASTIMAGEN	9, Inside Back Cover
EREMA	21	PROTEC Scandinavia	12
Erge	27	Sesotec	21
FDM	13	SI Group	16
First Quality Chemicals	22	Smart Extrusion	Outside Back Cover
Gabriel-Chemie	10	Songwon	22
Gneuss	32	Stein Maschinenbau	Inside Front Cover+3
Guill	23, 19	Tecnomatic	11, 26
Herrmann Ultraschalltechnik	17	Tube	8
interplastica	13	wire	8
Jwell	7	Zolet, Jean	36
Kabel.Consult.Ing.	18	Zumbach	19
KraussMaffei Extrusion	12		

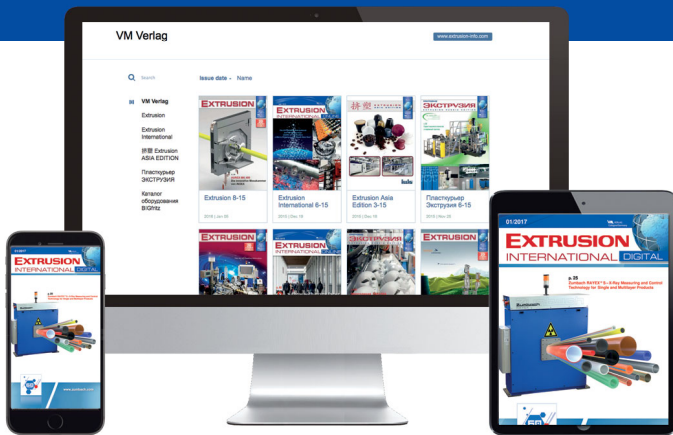

Follow the news  
in the world  
of extrusion!

Subscribe to digital magazines  
and Smart Extrusion weekly newsletter

- **Just** submit your **e-mail address**.
- Digital magazines and news updates **free of charge**
- No spam. Your data is safe



[www.extrusion-info.com/subscription](http://www.extrusion-info.com/subscription)





The Extrusion International Magazine is published bimonthly by VM Verlag GmbH. P.O.Box 501812, D- 50879 Cologne, Germany

**EDITORS**

Bettina Jopp-Witt (Editor-in-chief)  
Tel. +49 221 546 1539  
redaktion@vm-verlag.com

Dmitry Kosuch  
Tel. +7 996 730 0113  
d.kosuch@vm-verlag.com

**ADVERTISING SALES**

Martina Lerner  
Tel.+49 6226 971515  
lerner-media@t-online.de

Bella Eidlin  
Tel. +49 152 29907895  
b.eidlin@vm-verlag.com

Olga Kirchner  
Tel. +49 152 05626122  
o.kirchner@vm-verlag.com

**ADMINISTRATION**

Alla Kravets  
Tel. +49 2233 949 8793  
a.kravets@vm-verlag.com

**PRINTING**

maincontor GmbH  
Dr.-Gammert-Str. 13a, 63906 Erlenbach, Germany  
T.: +49 937294810811  
www.maincontor.de, info@frankhohmann.com

**SALES REPRESENTATIVES**

Quaini Pubblicita (Milano IT)  
Tel. +39 02 39216180  
info@quaini-pubblicita.it

China & Asia  
octavia@ringier.com.hk, Tel. +852-9648-2561  
maggieliu@ringiertrade.com, Tel. +86-13602785446

Tokyo PR Inc. (Japan)  
Tel. +81 (3) 3273-2731  
extrusion@tokyopr.co.jp

**Reprints, Translation etc**

No part of this publication may be reproduced, stored in a retrieval system, or transmitted, in any form or by any means, electronic, mechanical, photographic, recording or otherwise, without prior permission of the publisher.



[www.smart-extrusion.com](http://www.smart-extrusion.com)

**JWELL**

CE TÜV CERT ISO 9001:2015

**JWELL MACHINERY CO.,LTD.**

+86-512-53111818 53377158 53377171 53730369  
+86-519-87836658 87169158 87108958 87878918  
+86-21-69591097 69591818 69591111 69593311

[sales@jwell.cn](mailto:sales@jwell.cn)  
[www.jwell.cn](http://www.jwell.cn)



### Plastics Recycling Show Europe (PRSE)

27. - 28. 10. 2020  
Amsterdam, The Netherlands  
<https://prseventurope.com/>

### Central Asia Plast World

12 International Exhibition for Plastics and Polymer Industries  
12. – 20. 11. 2020  
Almaty, Kazakhstan  
<http://www.plastworld.kz/?lang=en>

### Plast Eurasia Istanbul 2020

02. - 05. 12. 2020  
Istanbul, Turkey  
<http://plasteurasia.com/en/>

### wire 2020 and Tube 2020

07. - 11. 12. 2020  
Düsseldorf, Germany  
[www.wire.de](http://www.wire.de), [www.Tube.de](http://www.Tube.de)

### Plastimagen

11. - 14. 01. 2021  
Mexico City, Mexico  
[plastimagen.com.mx/2020/en](http://plastimagen.com.mx/2020/en)

### Future of Polyolefins "Designing for Recyclability"

20. - 21. 01. 2021  
Düsseldorf, Germany  
[www.wplgroup.com/aci/event/polyolefins-conference/](http://www.wplgroup.com/aci/event/polyolefins-conference/)

### POWTECH India 2020

11. - 12. 02. 2021  
Mumbai, India  
[Powtech-india.com](http://Powtech-india.com)

### interpack

25. 02. - 03. 03. 2021  
Düsseldorf, Germany  
[www.interpack.de](http://www.interpack.de)

## Industry and Associations stand by Trade Fair Dates: wire and Tube will be held

■ Messe Düsseldorf creates all the requirements for holding successful and hygiene-conforming trade fairs in COVID-19 times – enjoying strong support from the industries and their professional associations. The European umbrella organisations as well as major companies of the leading international trade fairs wire and Tube clearly speak out in favour of the trade fair dates from 7 to 11 December 2020 at Düsseldorf Fairgrounds.

In a meeting of the European associations acting as conceptual sponsors of the events in Düsseldorf the decision has now been taken that a commitment to the leading trade fairs from their respective sectors of industry is indispensable despite these challenging times. Personal encounters, one-on-one conversations and the expert exchange at the trade fair stand have never been more important than in the current situation.

"All parties are making an effort to return to a normal course of affairs in spite of the existing COVID-19 measures and risks," says Dr. Uwe-Peter Weigmann, CEO of WAFIOS AG and President of VDKM. Weigmann adds: "We are confident that personal conversations and live demonstrations of machinery offered by a trade fair cannot be replaced by video conferences. This is why WAFIOS will exhibit its latest innovations at the trade fair – albeit on a smaller scale than usual. We are aware that the trade fairs in December will not be comparable to a "normal" wire & Tube. But we expect customers to come and want to be at their service. Since Messe Düsseldorf has shown at the CARAVAN SALON that it can and does implement the necessary hygiene measures to keep risks to a minimum for both exhibitors and visitors, WAFIOS also wants to send a signal with its participation: business must carry on and even in COVID-19 times personal conversations can be had to a limited extent and in a protected setting complying with hygiene rules."

Nevertheless, the international situation has to be re-assessed anew every day. "We are aware that in the current situation most visitors will come from Europe to see us and wire and Tube will have a primarily European character in 2020," says Daniel Ryfisch, Project Director wire, Tube & Flow Technologies at Messe Düsseldorf.

"We are all the more delighted to send a positive signal to the industries by holding the two events," adds Friedrich-Georg Kehrer, Global Portfolio Director wire, Tube & Flow Technologies.

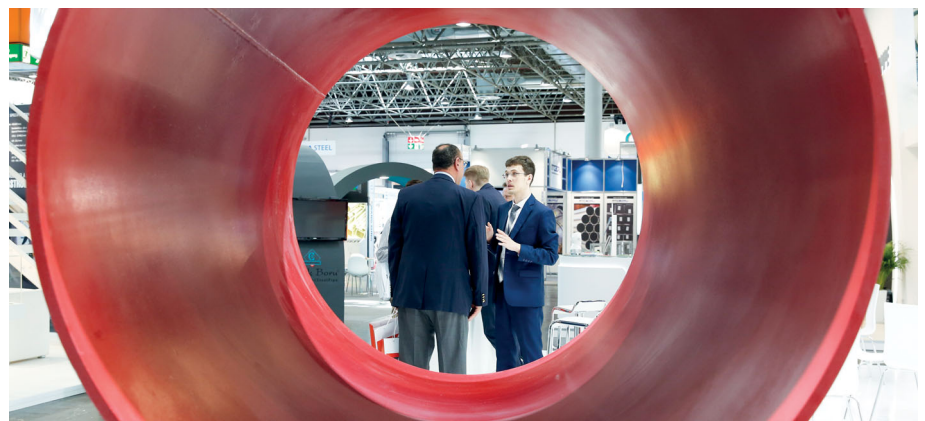

(Photo Messe Düsseldorf, Constanze Tillmann)



## PLASTIMAGEN Mexico Announces its Next Edition

■ The edition of PLASTIMAGEN® Mexico, the most important meeting of the plastics industry in Latin America, will be held from January 11 to 14, 2021 at the Citibanamex Center in Mexico City, with the participation of more than 870 companies and 1,600 brands, from 27 countries.

The event is supported by the National Association of Plastic Industries (ANIPAC), will represent the relaunch of the industry and will be the best business opportunity and reactivation of the economy.

PLASTIMAGEN® Mexico will offer attendees innovations and solutions for companies in machinery and equipment, raw materials, transformation of plastics and products, as well as services for the industry of the sector.

PLASTIMAGEN® México is a meeting that encourages the generation of business in the country and Latin America in the face of the most innovative trends in the plastics industry.

This material has contributed in an important way to improve the quality of life of people, at the same time that it generates an important technological and economic development. Faced with the health and hygiene needs, plastics have become a material that is a guarantee of cleanliness and the safety of food and other products.

In Mexico, this industry is made up of more than 4 thousand companies and contributes more than 3 percent of the Gross

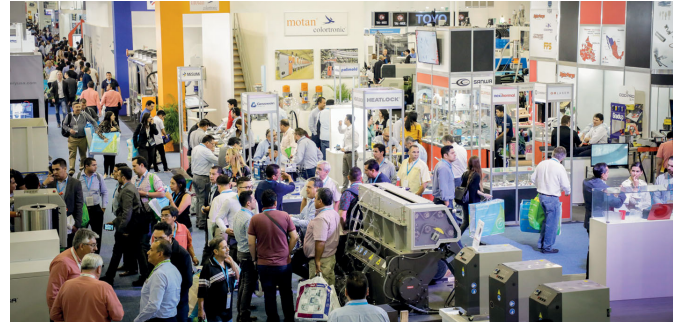

Domestic Product and 5 percent of the manufacturing GDP. Additionally, the sector generates more than one million jobs directly and indirectly.

This same country annually exports four million tons of plastic and generates sales of more than 17 billion dollars a year.

With a firm commitment to preserving the environment, the Mexican industry recycles one million tons of plastic waste each year.

PLASTIMAGEN Mexico will offer attendees industrial solutions and new business strategies for companies.

► [www.plastimagen.com.mx/2020/es](http://www.plastimagen.com.mx/2020/es)

## Activities in the European Plastics Market Booted

■ PIXARGUS develops, produces and sells optical inline measuring and inspection systems for customers around the globe. The company is active worldwide, with a global network of technical representations and a branch office in the USA. PIXARGUS is now staffing up its sales force in Europe to boost its activities in the European market. "With the engagement of Enrico Buran and Bob Craddock we are taking a decisive step towards enhancing our market presence in Europe," says Michael Frohn, Sales Manager of PIXARGUS.

Enrico Buran is from now on the responsible sales representative for customers in Italy. Bob Craddock will represent PIX-

ARGUS in the United Kingdom. Bringing many years of experience as sales professionals, they are both experts in their respective regional markets. They are very well networked and have excellent contacts within the plastics industry. Craddock: "PIXARGUS is a leading developer and manufacturer of optical inspection systems. I'm excited about the challenge to take a fresh approach to the PVC market together with PIXARGUS, adding to the momentum of the positive business development, in particular in the window seals segment."

The new sales representatives will start their new journeys with two novel PIXARGUS-developed products in their bags: the new Two-in One AllRoundDia DualVision system for complete 360° inspection of rounds and the new iProfilControl for inline quality inspection of sections. "With these products, we can now supply quality made in Germany at prices attractive for low budgets," says Buran.

PIXARGUS Sales Manager Michael Frohn is convinced: "For our customers our enhanced local presence means even more effective and immediate on-site support in all sales and service-related matters." A sales representative for Scandinavia is to be appointed soon.

*As new sales representative of PIXARGUS, Enrico Buran is from now on the first port of call for customers in Italy*



*Sales expert Bob Craddock is going to represent PIXARGUS in the UK markets*



► PIXARGUS GmbH  
[www.PIXARGUS.de](http://www.PIXARGUS.de)

## NPE2021



**NPE2021**  
The Plastics Show

NPE2021, May 17–21, 2021, Orlando, Florida, USA

■ The Plastics Industry Association (PLASTICS), producers of NPE: The Plastics Show, announced the opening of attendee registration for the industry's largest trade show in the Americas.

Every three years, NPE® offers the plastics industry a global platform to highlight innovation throughout the industry across a show floor that features more than 1.2 million net square feet of exhibit space. With 2,100+ exhibitors spotlighting the latest technologies, equipment and machinery, materials, and processes across 13 distinct technology zones, including 3D/4D printing, bottling, robotics and automation, and flexible and rigid packaging.

"NPE2021 is the premier event for all sectors of the plastic industry to network, exchange ideas, and see the latest innovations molding the future of plastics," said President and CEO of PLASTICS, Tony Radoszewski, CAE. "Attendees will be able to learn about emerging plastics trends; purchase the latest machinery, materials, and equipment that are revolutionizing manufacturing; and connect with industry leaders. Given the challenges of the past six months, it is vitally important for the plastics community to come together and support each other with a positive outlook to the future," said Radoszewski. "NPE2021 will be the place not only to highlight key contributions in the world's response to the coronavirus but also to see what's coming from businesses across an industry that will transform tomorrow."

Earlier this year, PLASTICS held the show's Space Draw for priority exhibit space selection. This was the first time the Space Draw was conducted completely online. Previ-

ously, NPE exhibitors needed to attend an in-person event in Orlando to select their exhibit space. It was the second-largest space selection event in the history of the show, just one percent shy of the all-time record, and subsequent sales have resulted in a show floor exceeding one million net square feet of space sold to nearly 1,200 participating companies.

"Even in the midst of the COVID-19 pandemic, we have seen overwhelming interest and enthusiasm by exhibitors reserving their show floor spaces," said Susan Krysz, PLASTICS' Vice President, Trade Shows. "That's a clear indicator that companies are looking to NPE2021 to be the platform that will enable them to drive their businesses forward. Their confidence in NPE providing them with that important marketplace speaks to the strength of the show and the role it will play in their future success."

As the plastics industry continues to help in the fight against COVID-19, NPE will highlight both transformed manufacturing processes and redesigned supply chain operations that deliver personal protective equipment to healthcare workers. The trade show will also feature the latest evolutions in MedTech and 3D/4D printing that are keeping first responders and frontline workers safe against the coronavirus. By bringing companies at the forefront of plastics manufacturing together, the industry will be able to collaboratively solve today's needs and reimagine how to meet tomorrow's challenges.

► [NPE.org](https://NPE.org)  
[NPE.org/registration](https://NPE.org/registration)

The Plastics Industry Association (PLASTICS)  
[plasticsindustry.org](https://plasticsindustry.org)

## Company Anniversary



■ On the occasion of its 70th company anniversary, Gabriel-Chemie is demonstrating that tradition and innovation can go together hand in hand. These are the core values which the Austrian masterbatch manufacturer holds especially dear.

The family business, now in its second generation, places great emphasis on sustainable product development and ongoing customer relationships.

Having been around for 70 years, the masterbatch manufacturer is on the way with an active third generation to a sustainable and innovative future, continuing to ensure and further strengthen its existence as an independent family-run business in the long-term.

"As part of his vision for the company, my father already placed great emphasis on innovation and stability for the business. He was always open to new ideas and possibilities even then. That is why, in addition to all the innovative developments, our traditional values as a family business and sustainable growth are the basis of our business philosophy today", says Elisabeth Sommer, daughter of the company founder Josef Houska and CEO at Gabriel-Chemie.

In its anniversary year, Gabriel-Chemie will continue to implement a sustainable concept and even expand it. The focus here will include the development of sustainable products and maintaining sustainable business relationships.

During the anniversary year, Gabriel-Chemie published its first sustainability report, which is intended to highlight and underline the company's philosophy.

► [Gabriel-Chemie Gesellschaft m.b.H.](https://Gabriel-Chemie-Gesellschaft-m.b.H.)  
[www.gabriel-chemie.com](https://www.gabriel-chemie.com)



## Change of Leadership

■ Thomas Dohse has been the new leader of interpack in his capacity as Project Director since the start of September. He follows Bernd Jablonowski, who rose to the Managing Board of Messe Düsseldorf as an Executive Director.

Dohse has woven an excellent web of connections within the global packaging industry and the related process industry. He has been part of the interpack team at Messe Düsseldorf since 2005 and led interpack 2017 on an operative level as Deputy Director.

The upcoming interpack in Düsseldorf was postponed from its original date in May 2020 to the following year, due to the Corona pandemic. It will now take place from 25 February to 3 March 2021 and continues to be fully booked.

Messe Düsseldorf relies on a comprehensive hygiene concept in order to protect exhibitors and visitors. “interpack is the most important event in the international packaging industry and, especially in times of crisis, provides crucial stimuli in order to build a successful future for the companies involved. Therefore, we give our all in order to do justice to this responsibility and simultaneously guarantee the best possible protection of the health of



Thomas Dohse

the people coming to our trade fair centre”, emphasises Thomas Dohse.

The hygiene plan has already proved that it lives up to its motto: “PROtaction –Back to Business” with Caravan Salon, the first trade fair at the Düsseldorf trade fair centre after the Corona break. After selling personalised tickets exclusively online before the trade fair, extensive hygiene measures shaped implementation of the concept on-site. Details on:

Messe Düsseldorf GmbH  
www.interpack.com

## INDUSTRY 4.0 Enabled



- REAL-TIME SYSTEM STATUS
- ETHERNET CONNECTIVITY
- REMOTE MONITORING
- SMART FACTORY COMPATIBILITY
- SENSORS SYSTEM PERFORMANCE
- PREVENTIVE MAINTENANCE DIAGNOSTICS

## Enhance the concept of pipe extrusion.

The investment in INDUSTRY 4.0 brings about an increased productivity and quality of the processes, and as a consequence a reduction of the overhead costs. Tecnomatic's PIPE 4.0 is the most up-to-date and state-of-the-art dedicated software in the market. INDUSTRY 4.0 allows preventive maintenance procedures and the recording of the efficiency of the machines themselves, but in particular it monitors all production activities, providing precise and timely data on order management, production phases and estimates and calculates production costs.

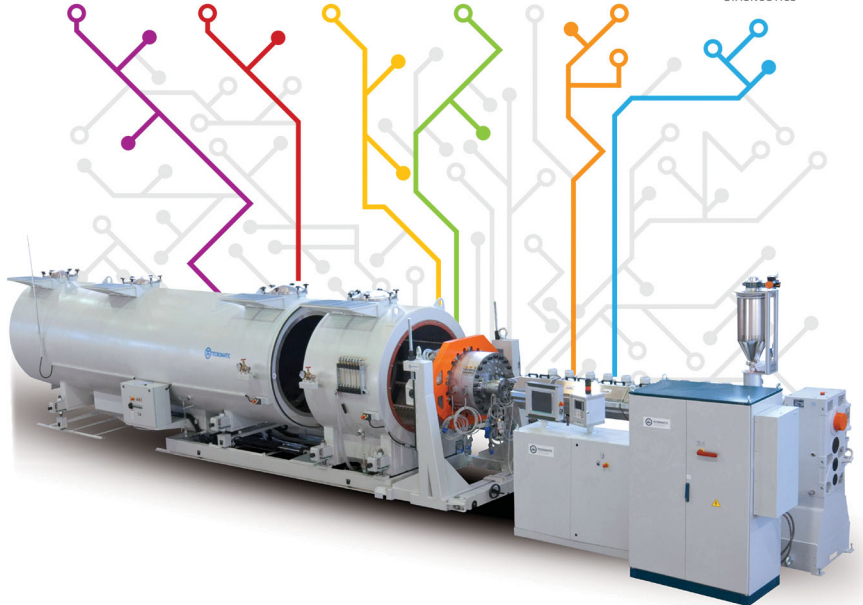

**TECNOMATIC**  
TECHNOLOGIES FOR PLASTIC PIPES PROCESSING

Tecnomatic Srl - Bergamo (Italy)  
tel. +39 035 310375 - tecnomaticsril.net

## Foundation Stone for New Company Premises

■ On 3 September 2020, KraussMaffei and VGP – a leading project developer for high-quality logistics and commercial real estate – officially laid the foundation stone for the construction of a new production plant for extrusion systems in Laatzen's eastern industrial park located in the Hannover/Germany region. According to the time schedule, the 66,500 square meter facility is planned to be completed by the third quarter of 2022. The new address will replace the former KraussMaffei site in Hannover-Kleefeld that did not allow any further expansion. In the third quarter of 2022, up to 750 employees will be working here at innovative workplaces in order to produce extrusion systems for the plastics and rubber industries.

Ultra-modern premises with impressive office and production areas will be built on the spacious site to combine KraussMaffei's extrusion business activities under a single roof. Special focus is placed on the new InnovationCenter that will be available for challenging and complex preliminary

*New KraussMaffei plant covers 66,500 m<sup>2</sup> offering ample space for up to 750 workplaces in production, assembly and administration*

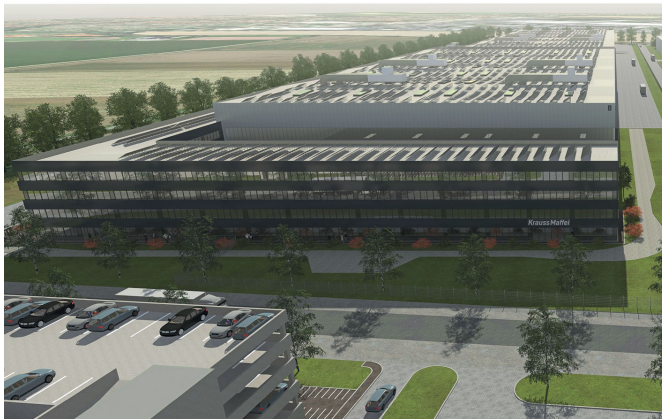

*In the presence of Lower Saxony's Minister-President Stephan Weil, Laatzen's Mayor Jürgen Köhne, Jan Van Geet, Chairman of the VGP Board of Management, Dr. Michael Ruf, Chief Executive Officer of the KraussMaffei Group and Dieter Thewes, Chief Operating Officer of KraussMaffei Extrusion GmbH, the foundation (Photos. KraussMaffei)*

tests under realistic production conditions to customers from the plastics and rubber industries before they actually order a new machine from KraussMaffei. On a floor area of around 10,000 square meters, the InnovationCenter will comprise 20 state-of-the-art machines and lines – from small laboratory facilities up to production-scale machines – to be used for trial purposes. Completion is proceeding according to schedule.

The new plant in Laatzen is already the third joint project KraussMaffei implements with the support of VGP's experience and expertise.

► KraussMaffei Extrusion  
[www.kraussmaffei.com](http://www.kraussmaffei.com)

## Majority Stake in Norwegian Machine Trading Company Acquired

■ On July 14 the Feddersen Group acquired 75% of the shares in the Norwegian company PROTEC Scandinavia AS and 100% of the shares in PROTEC Scandinavia Sweden AB from Pemel Holding AS. Both companies trade in machinery and equipment for the plastics processing industry and represent long-established manufacturers in this segment. With the acquisition of the shareholdings, the Feddersen Group is further expanding its regional presence in Northern Europe and will in future serve the Norwegian market

with a legally independent company and its own sales structure. The portfolio of PROTEC Scandinavia AS will soon be expanded to include the distribution of engineering plastics. PROTEC Scandinavia Sweden AB is to be integrated into K.D. Feddersen Norden AB. Synergies within the group of companies are also to be exploited to a greater extent.

► PROTEC Scandinavia AS  
[www.protecscandinavia.com](http://www.protecscandinavia.com)



## interplastica sends Important Signal in Difficult Times

■ The Covid-19 pandemic currently faces businesses around the globe with very special challenges. Like the international trade fair business. Trade fairs have been cancelled worldwide but the industry is not at a standstill. After all, trade fairs are urgently needed for re-starting the economy as a whole. They are indispensable experience and communication platforms for entire sectors of industry where contacts can be established, experiences exchanged, knowledge gathered and innovations appraised live.

interplastica 2021 will be held again at the AO Expocentre in Krasnaja Presnja in Moscow. To guarantee the highest degree of safety for exhibitors, visitors, partners and employees, Messe Düsseldorf Moscow is currently developing a comprehensive hygiene and infection protection concept in close coordination with the operator of the exhibition centre and in compliance with the hygiene regulations in force in that country to be employed at interplastica.

Exhibitors' brisk demand confirms that companies in the plastics and rubber industries welcome the opportunity to gain exposure on such a relevant market especially during such difficult times.

Alongside machinery, raw materials and equipment the focus will again be on the circular economy and recycling themes in the coming year. The Recycling Solutions segment featuring highly specialised enterprises was received very well at its debut during the previous interplastica and will also be continued in 2021 with accompanying discussion forums revolving around waste management and circular economy.

Beyond this, innovative technologies for all sectors of plastics processing will be showcased not only at the exhibitors' stands but also addressed in the lectures and discussions at the Polymer Plaza and as part of the special show 3D fab+print Russia. Experts



here will again pick up on current developments and additive manufac-

turing possibilities in technical talks and demonstrations.

Held concurrently with interplastica will be upakovka 2021, the No. 1 Trade Fair in Russia for Processing and Packaging.

► [www.interplastica.de](http://www.interplastica.de)

### High precision dosing technology for broad application



## GDS Twin Screw

### Gravimetric dosing system

- Suitable for powders such as Caco3, talc, pigments and others
- No material bridges in weighted hopper and screw inlet
- No adherence of material at the screw surface
- Available both as stand-alone and system integrated solution
- Dust sealed
- Operator friendly design
- Siemens control

\ [fdm.piovan.com](http://fdm.piovan.com)

 **Fdm**  
Piovan Group

## Market Study: Masterbatches – World

■ Colorants and flavors for beverages are often not directly mixed with water and prefabricated, ready-to-use syrup concentrates are used instead. In the production of plastics, too, so-called masterbatches – granules with a high concentration of colorants, other additives, or fillers – are preferred to powders, pastes, or liquid additives. Premixed concentrates with precisely defined properties facilitate processing and increase process reliability: color masterbatches contain pigments or dyes; additive masterbatches specifically modify other properties of plastics. A wide variety of additives can be combined, for example stabilizers, antioxidants, antistatics, or flame retardants. Ceresana is now publishing the second, completely revised edition of its market study on masterbatches: the global demand for plastic masterbatches is expected to rise to almost 4.5 million tonnes by 2027.

The Study in Brief: Chapter 1 provides an overview and analysis of the global market for plastic masterbatches – including forecasts up to 2027: the development of demand and revenues is examined for each region of the world. Demand is broken down into the different types of masterbatches. The different application areas are also examined separately.

Chapter 2 examines the 16 most important countries individually. The study presents demand per country, demand per type of masterbatch, as well as revenues. Demand is also analyzed according to the individual application areas.

## Market Study: Masterbatches - World (2<sup>nd</sup> edition)



Chapter 3 offers a useful list of the 52 most important producers of plastic masterbatches. It is clearly arranged according to contact data, revenues, profit, product portfolio, production facilities, and profile summary.

■ Ceresana  
[www.ceresana.com/en/market-studies/plastics/masterbatches/](http://www.ceresana.com/en/market-studies/plastics/masterbatches/)

## New Regional Sales Manager in South Asia

■ Nordson Corporation has appointed Rahul Pillai as regional sales manager on the Indian Subcontinent for BKG® pelletizing and melt delivery systems. He will be responsible for sales of underwater pelletizers, screen changers, gear pumps, diverter valves, and ovens.



Rahul Pillai

“Rahul’s experience with MRVP Consultants as the technical and sales head, along with his manufacturing and engineering experience, has given him a unique perspective,” said Mrunal Sanghvi, general sales manager for Nordson’s Polymer Processing Systems business in India. “He will play an important role in our program of expanding the sales and service capabilities for BKG products in India and the Subcontinent.”

Rahul Pillai comes to Nordson after four-years at MRVP Consultants, where he was responsible for sales and technical support. Previously, he held key roles in manufacturing, maintenance, and engineering at Sun Polyblend Pvt., Ltd., Jai Corp Ltd., and Kandui Ind. (P) Ltd.

■ Nordson Polymer Processing Systems  
[www.nordsonpolymerprocessing.com](http://www.nordsonpolymerprocessing.com)



## General Sales Manager in Asia Appointed

■ Chew Yew Kwong has joined Nordson Corporation's Polymer Processing Systems (PPS) business as general sales manager in Asia for Xaloy® extrusion and injection molding components. Chew will be responsible for sales of Xaloy screws, barrels, and front end components. He will coordinate with other Nordson teams to serve customers ordering multiple PPS products.



Chew Yew Kwong

"Chew Yew Kwong has more than twenty years of experience in international sales and operations management," said Teong HK, vice president of PPS Asia. "His polymer industry knowledge and management expertise will be a valuable addition to our mission of providing excellent support to customers throughout Asia."

The company's Asia manufacturing facility for Xaloy products is located in Chonburi, Thailand.

■ Nordson Polymer Processing Systems  
[www.nordsonpolymerprocessing.com](http://www.nordsonpolymerprocessing.com)

## Acquisition

■ Switzerland-based MAAG Group has strengthened its digital capabilities by acquiring Germany-based XanTec Steuerungs- und EDV Technik GmbH ("XanTec").

XanTec plans, designs and manufactures advanced industrial control systems that are employed in production plants, pelletizing systems and extruders, thereby improving process control and machine intelligence to reduce cost and improve quality.

"Thoughtfully applied digital technologies enable Maag to provide world-class intelligent, agile and competitive solutions to our customers. This acquisition fits perfectly with our strategy to strengthen our digital capabilities," said Ueli Thuerig, President of the MAAG Group. "Additionally, this acquisition is aligned with our goal to continue expanding our portfolio with industry-leading systems and solutions."

XanTec Managing Director, Hilger Schürmann, stated, "We are excited to partner with the MAAG Group and appreciate the recognition of XanTec's solutions and technology. Digitalization is an important trend in our industry, even more so in today's economic environment. XanTec has a portfolio of digital products and solutions that holds incredible promise to generate new sources of value."

■ MAAG Group  
[www.MAAG.com](http://www.MAAG.com)

motan®  
colortronic®

## Perfect and constant dosing

think materials management



### SPECTROPLUS

A dosing unit for all extrusion and compounding tasks.

motan-colortronic gmbh - [info@motan-colortronic.de](mailto:info@motan-colortronic.de)  
[www.motan-colortronic.com](http://www.motan-colortronic.com)

## Extrusion Drying

■ Axminster-based Air Control Industries, ACI®, a world leader in the design and manufacture of industrial air movement products, has announced that it has achieved the internationally recognised Made in Britain accreditation for its range of products developed, designed and manufactured at its UK headquarters in Devon.

A major force in the field of drying solutions for the cable, wire and extrusion industries and industrial fans used in everything from grain ventilation to pharmaceutical manufacturing, ACI supplies cutting edge solutions supporting a global audience of customers in more than 40 countries.

Among its range of products, ACI designs and supplies air knife drying systems, bottle and can drying solutions and a range of JetBlack® Safety personnel cleaning booths, which remove and safely collect potentially harmful dust from staff and their clothing. This prevents transmission into the wider environment, enhancing the health and wellbeing of workforces and communities internationally.

Commenting on the accreditation, ACI UK Sales Manager, Matt Shelley, said: "Air Control Industries has a proven track record in air movement engineering with a pedigree that goes as far back as the 1960s. Our focus throughout has been constant innovation, using the best of British knowledge, expertise, skills and materials to produce global leading products. Working closely with our clients, many of which are household names, we create state-of-the-art solutions, individually tailored as required. These are backed by the CE Mark, ISO 9001, as well as industry, national and international standards that ensure complete client satisfaction. The Made in Britain accreditation endorses all that we stand for in terms of focusing on the delivery of the very highest levels of quality; from design, through development to production. Backed by cus-



tomers service levels, engineering precision and craftsmanship that are the envy of the world, we are proud to fly the flag for Britain and to carry the Made in Britain stamp of quality on our domestic and internationally exported products."

Made in Britain brings together the British manufacturing community, united by the use of the registered collective mark of quality. Providing the ultimate mark of British provenance, the Made in Britain mark is seen as an international seal of excellence domestically, in Europe and across the world.

To qualify for the mark, manufacturers must pass a stringent 150-point checklist to guarantee that the manufacturing supply chain is 'truly British'. Only those products that pass this test are permitted to carry the mark.

A select group of just 1,260 manufacturers across Britain have so far been given permission to carry the Made in Britain brand.

► Air Control Industries (ACI)  
[www.aircontrolindustries.com](http://www.aircontrolindustries.com)

## Tackifier Capacity Expansion in China Announced

■ SI Group, a global leader in the innovative technology of performance additives, process solutions, active pharmaceutical ingredients, and chemical intermediates announced plans to expand capacity levels at its Nanjing, China facility. The expansion will increase production by more than 50%, propelling the site to become a regional hub for best-in-class tackifier and reinforcing resin production and technology.

SI Group's Nanjing investment is in lock-step with the desire to reinvent its business model, addressing the emerging trends in the tire industry. "We have taken the appropriate steps necessary to grow our capacity in this key regional growth area", stated Robert Kaiser, Vice President, Rubber & Adhesives Solutions at SI Group, adding: "This expansion allows us to differentiate our offerings and position in the market, providing superior so-

lutions to our customers." SI Group's expansion in Nanjing will also address energy conservation initiatives and sustainability efforts in compliance within a highly-regulated Chinese chemical industry.

SI Group has a long history of manufacturing tackifier resins used to enhance the performance and durability of tires. In addition to tackifier resins, the company also has a robust portfolio of bonding, curing, and reinforcing resins, manufactured globally. The company is currently undergoing a thorough environmental and safety permit review for the Nanjing expansion, in accordance with all local Chinese government regulations.

► SI Group  
[www.siigroup.com](http://www.siigroup.com)



## Software Tools against Covid-19

■ In the fight against the corona virus, ventilators and corona tests have come to the fore. Herrmann Ultraschall supplies well-known manufacturers with the welding technology to assemble the necessary components such as mouth and nose contact pieces, floats, filters and housings. The two software tools FSC and SonicCalibrate developed by Herrmann play an important role for quality assurance in the ultrasonic welding process.

To ensure the required accuracy and tightness during joining, these software tools provide support in controlling the ultrasonic system. They enable reproducibility and traceability for the manufacturing process and fine adjustment and amplitude control for demanding materials.

In order to achieve a reproducible welding result and a constant welding process, it must be ensured that the relevant machine parameters have the same values reproducibly. The SonicCalibrate software is used to calibrate and verify the weld depth, weld force, sonotrode speed and amplitude. The correctly set speed prevents damage to sensitive seam geometries. In addition, it influences the maximum joining speed and the displacement of the melt in the subsequent joining process. The amplitude is decisive for the introduction of the ultrasonic power into the component and is therefore dominant in melt formation and the joining process. This is particularly important for sophisticated medical parts.

This software offers the functionality to comply with the strict regulations of the American FDA (21 CFR Part 11) for tracking, as often required in the food, pharmaceutical and medical industries. It includes user administration and authentication as well as control of user authorizations. In addition, changes to the system are recorded in an audit trail. The Herrmann Engineering provides encompassing support for welding process development: weldability tests, sample parts, seam design, technical implementation, TCO analysis, prototype tools and training.

*Many parts of a ventilator are welded using ultrasonic welding technology*



■ Herrmann Ultraschalltechnik GmbH & Co. KG  
[www.herrmannultraschall.com](http://www.herrmannultraschall.com)

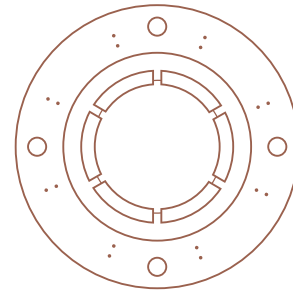

# CCA

The Original

### Innovation is our Passion

CCA offers different adjustable calibration sleeves to optimize your plastic pipe production – from 14 up to 2,600 mm pipe outside diameter.

Discover now the individual solution for your needs:

- conventional
- 2-point adjustment
- 1-point adjustment
- 4-point adjustment



[ccagmbh.de](http://ccagmbh.de)



## “Energy-light” Drive System at wire & Tube 2020

■ Juan Carlos González Villar, proprietor of Kabel.Consult.Ing: “We are so pleased to display at wire & Tube 2020 our “Energy-light” drive system, winner of British “Motion Control Industry Award 2019/20. This high-profile industry prize acknowledges our commitment to first-class development work as well as our market position as a contract development firm and problem solver. We also see the results of the jury voting as evidence that this innovative product will be well received at wire & Tube 2020 by exactly the same group of people for whom it was developed: the pioneers of Industry 4.0 and e-mobility. ”

The “Energy-light” drive system combines all four industrial era and opens up new opportunities: Industry 1.0 and 2.0 (Robert Willis<sup>2</sup> [English academic, Cambridge professor and publisher of “Principles of Mechanism”], G. J. Abott [English inventor and patent holder of the mechanical continuously variable transmission -> Patent US2068784, 1934] -> Pioneers and idea giver); Industry 3.0 (Semiconductor and PLC technology [programmable logic controller] -> Digitalization, Energetic Networking, CIM Computer-integrated manufacturing); Industry 4.0 (Cyber phys-

ical systems, AI, Automation of intelligent behaviour -> Smart Products).

The “Energy-light” drive system brings together innovative technology, cutting-edge process and control methods, and lightweight composite materials to significantly improve energy efficiency. It minimizes drive output during continuous operation, during acceleration, delays, and braking while maximizing generator output, resulting in a standardized drive system of a total application (drawing line, bunching/stranding/braiding line, extrusion line, rewinding line).

The “Energy-light” drive system brings together innovative technology, cutting-edge process and control methods, and lightweight composite materials to significantly improve energy efficiency. It minimizes drive output during continuous operation, during acceleration, delays, and braking while maximizing generator output, resulting in a standardized drive system of a total application (drawing line, bunching/stranding/braiding line, extrusion line, rewinding line).

<sup>2</sup> “The process of designing complex machines using mathematical, science-based Methods is one of the important achievements of the late industrial age and was advanced by Robert Willis (1800-1875) of Cambridge University. This new “engineer-scientist” broke with the workshop tradition of machine construction, incorporating mathematics, new engineering pedagogy, codification of machine practice and scientific principles into machine design that influenced generations of engineers well into the 20/21 century.”



**wire & Tube 2020 (7 - 11 December, Düsseldorf, Germany):  
Booth 05-3**

■ Kabel.Consult.Ing  
[www.kabelconsulting.de](http://www.kabelconsulting.de)

## Integration Completed

■ Loparex, the leading global producer of release liners and engineered films, announced that it had successfully completed the integration of specialty film producer Infiana Group into its organization. The integration process, which began in September of last year, focused on maximizing synergies between the two companies, building on their existing strengths while simultaneously streamlining organizational structures and processes to better serve customer needs.

Loparex produces liner solutions through global segment teams covering the following key markets: Graphics, Tapes & Converting, Building & Construction, Health Care, Hygiene, Labels, Composites, and Developing Applications. These segments are served by an agile global production network with strategically located manufacturing sites in the United States, Germany, Holland, China, and India.

Each location offers local production options and in-depth technical expertise, while leveraging know-how and capabil-

ities from the greater Loparex organization for added flexibility and reliability of supply. Additionally, a new matrix-based market approach and newly designed sales structure allow for faster decisions, reduced time to market, and more efficient service.

The newly expanded Loparex portfolio encompasses direct coated and poly coated paper liners alongside direct coated, poly coated, blown and cast film solutions. A broad range of substrates and paper types, coupled with in-house embossing, coating, slitting, and printing capabilities, allows Loparex to provide the optimal match for any application. The company also offers unique solutions such as discreet and ultra-lightweight pouch films, liners with permanent antistatic equipment, and air egress liners for graphic applications.

Loparex’s global production and process development network leverages the expertise of two technology centers – in Cary, USA and Forchheim, Germany – to support customers’ more complex application needs.

■ Loparex LLC  
[www.loparex.com](http://www.loparex.com)

## Extrusion Tooling

■ Guill introduces the latest generation of its Series 800, the 2-to-6 layer extrusion tooling designed to produce the highest quality, highest material-efficient 1/8" to 6" OD tubing for automotive, medical, appliance and industrial applications. The redesigned Series 800 produces flawlessly smooth extrusion and layer definition of Fluoropolymer and other materials for all multi-layer, multi-lumen medical tubing, as well as fuel line constructions, multi-layer PEX pipe and drip irrigation applications, among others. The Guill design further allows thin layer combinations of polymers and adhesives to .02mm or less.

Guill offers its extensive line of crossheads and inline tubing dies in fixed and adjustable center, for single or co-extrusion applications. The tooling is designed to process all compounds and features the company's patented, precision Feather Touch Concentricity adjustment, the Seal Right Sys-

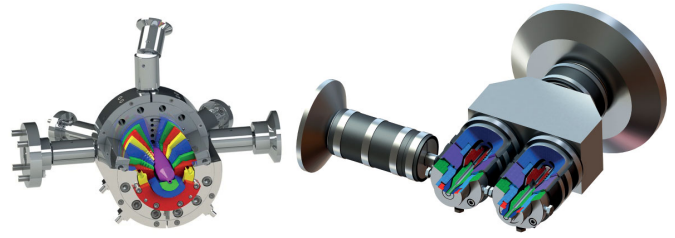

tem, which combines with the Feather Touch system to eliminate polymer leaking. Guill also offers its unique spiral flow distribution system.

All Guill tooling is produced with rigorous computer simulation of the flow channels using Computational Fluid Dynamics (CFD) programs, resulting in optimum uniform flow with no weld lines.

■ Guill Tool & Engineering  
[www.guill.com](http://www.guill.com)

## Precision Wall Thickness Measurement

**Zumbach**  
 SWISS PRIME MEASURING SINCE 1957

### RAYEX S XT

- Easy and quick set up for new products
- Fast eccentricity and diameter measurement
- Added longevity due to high-quality xray source



Family owned since 1957, Zumbach is a global leader in the industry. Driven by innovation and experience. We are here for you and ready to build the future together.

[www.zumbach.com](http://www.zumbach.com) • [sales@zumbach.com](mailto:sales@zumbach.com)



## Remote Commissioning and Modernization

■ Coperion successfully achieved the complex modernization of a ZSK 250 high-capacity extruder completely utilizing remote processes and support. As this recent example shows, Coperion has successfully evolved its modernization efforts to utilize the Coperion ServiceBox, an integrated system for online monitoring and failure recording in extruders and compounders, as well as communication methods like video and telecommunication to complete customer requests. This ZSK 250 extruder modernization package encompassed both a control software update as well as mechanical overhauls on the system. A significant throughput increase was achieved on the extruder by modernizing the gearbox, mounting a new coupling, installing a ZS-EG side devolatilization and updating the EpcNT control, including a rebuild of the control cabinet and monitor. Coperion's three member team, based in Stuttgart, Germany, worked directly with the customer to ensure proper software and mechanical updates. During this time when travel is limited by the pandemic, this achievement serves to show that Coperion is committed to the continued reliable rollout of its customer projects and hence their success.

Although Coperion has been utilizing the Coperion ServiceBox for many years to perform remote software updates on its extrusion systems, more complex mechanical remote tasks have been limited so far. With the successful modernization

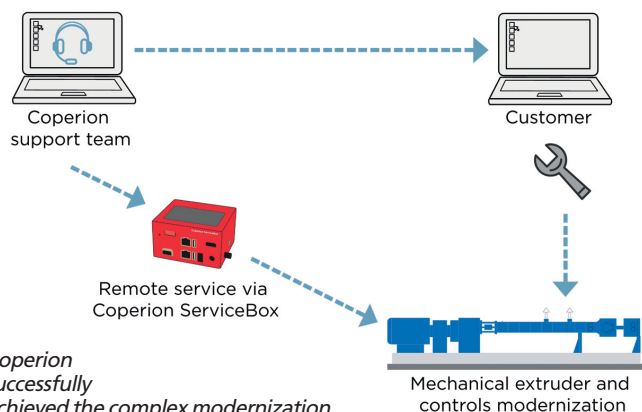

*Coperion successfully achieved the complex modernization of a ZSK 250 high-capacity extruder completely utilizing remote processes and support (Image: Coperion GmbH)*

of this ZSK 250 high-capacity extruder, the proof of concept has been realized and a milestone has been set for complex maintenance and modernization projects utilizing remote service. Whether under the current pandemic condition or as customers fundamentally shift work expectations, Coperion offers a lean, flexible solution for machine commissioning and modernization of its extruders.

■ Coperion GmbH  
www.coperion.com

## Bioplastics with Variable End-of-Life Options

■ As a branch of AKRO-PLASTIC, BIO-FED is the specialist for innovative and application-oriented biocompounds. The product portfolio under the trade name M•VERA® is constantly being expanded with new products. Depending on the requirements profile, these compounds are either biodegradable in various environments or suitable for long-term use – and completely or partially made from renewable raw materials.

The legislation in various European countries for film packaging is currently becoming increasingly stringent. For example, a biobased carbon content of 60% or more and the "OK compost INDUSTRIAL" certificate will be mandatory for the fruit and vegetable bags in Italy from January 2021. In France, this

*Fruit and vegetable bags – a good application for M•VERA® B5033*



carbon content does not have to be reached until the end of 2024. In this case, however, the specifications according to "OK compost HOME" must also be fulfilled for the fruit and vegetable bags, as has been the case up to now.

BIO-FED's comprehensive M•VERA® film range offers products with a high biocontent of 40 to over 50% and can serve various end-of-life scenarios – be it for industrial composting or domestic compost. The company is also researching a product that will have a bio-based carbon content of more than 60%.

"In addition to the composition and easy processing of the granulate, the films must also meet the mechanical requirements of the application," says Roland Andernach, Product Manager at BIO-FED. M•VERA® B5033, for example, has significantly improved the tensile strength and tear resistance for use in fruit and vegetable bags. With its experienced research and development team, the Cologne-based company can develop customer-specific solutions in addition to a standard range of products.

■ BIO-FED  
Zweigniederlassung der AKRO-PLASTIC GmbH  
www.bio-fed.com



# Keeping Plastic Compounds Free of Metallic Contaminants

*The RAPID PRO-SENSE 6 from Sesotec is a metal separator developed with the specific challenges of granulate, compound, and masterbatch producers in mind (Image: Sesotec GmbH)*



Granulate manufacturers and compounders have special requirements when it comes to protection against metallic contaminants. Not only must metal separators in this branch operate with high detection accuracy, but they must also guarantee short cleaning times. Reliable metal separators can increase line availability, ensure product quality, and prevent customer complaints. Particularly for compounding and masterbatch production lines, metal separators can improve profitability. The Whitepaper "Keeping metallic contaminants out of plastic compounds" explores the challenges that metal contamination poses to compounding and masterbatch production and considers the key features that metal separators must have to provide an adequate solution.

■ When it comes to plastics compounding and masterbatch production, a certain degree of machine wear and tear is part of doing business. On a semi-regular basis, machines must be replaced, parts changed out, and facilities retrofitted. While some machine downtime is unavoidable, materials harboring metallic contaminants can lead to frequent, unplanned stops that incur costly repairs and quality assurance issues. Metal separators play a key role in keeping metallic contaminants out of product streams.

The Whitepaper covers the following topics:

- Common sources of metal contaminants in compounding and masterbatch production
- The problems caused by metal contaminants
- Preventative measures against metallic contaminants
- What compounders expect from a metal separator

Sesotec GmbH  
[www.sesotec.com](http://www.sesotec.com)

## WE DRIVE THE CIRCULAR ECONOMY.



Whether it is inhouse, post-consumer or bottle recycling: you can only close loops in a precise and profitable way if machines are perfectly tuned for the respective application. Count on the number 1 technology from EREMA when doing so: over 6000 of our machines and systems produce around 14.5 million tonnes of high-quality pellets like this every year – in a highly efficient and energy-saving way.

CHOOSE THE NUMBER ONE.

**EREMA**<sup>®</sup>  
PLASTIC RECYCLING SYSTEMS

## Compact Solution for Small Conveying Systems

■ For standard conveying applications, motan's new METROVAC SG conveying station offers an optimal and inexpensive solution for smaller conveying systems. Consisting of a vacuum blower, a control and a cyclone dust filter, up to 8 hopper loaders can be connected to the PLC control.

The METROVAC SG station is available in various blower sizes between 0.85 and 4.3 kW. Thanks to the maintenance-free blower and in combination with a cyclone dust filter, the station is not only versatile, but can also be easily adapted to the size of your conveying system and expanded if needed.

In order to generate a reliable and constant vacuum, motan's conveying station uses side channel blowers. Especially with short to normal conveying distances, these are ideally suited for placing directly next to the processing machines with low noise.

The FC filters combine cyclone dust separators with a fine dust filter. The transparent dust collector makes removing accumulated dust quick and easy.

When using the optionally available bypass valve, filter cleaning is carried out automatically. Likewise, the filter cartridge is regularly cleaned by implosion air that flows through the cartridge.

For quick and trouble-free material changes, it is also possible to thoroughly clean the material feed lines of any material after each conveying cycle. Among other things, this is particularly important when conveying hygroscopic materials.



*Quick and easy to clean: the modern cyclone filter with transparent dust collecting bin*

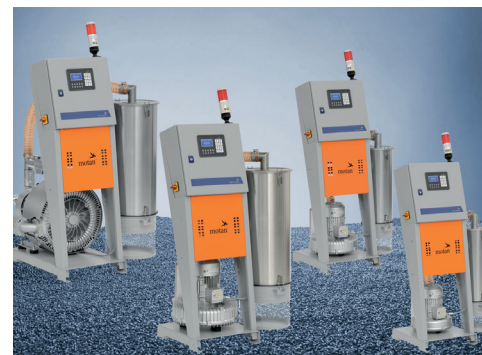

*The new METROVAC SG conveying station in the sizes 3.4kW, 2.2kW, 1.3kW and 0.85kW (from left to right) (Images: motan group)*

The PLC control is robust and user-friendly and is located at an ergonomically comfortable working height. An alarm combination of signal light and horn is already installed as standard. Up to 8 METRO SG HOS hopper loaders, up to 8 METROMIX / DUOMIX proportioning valves and up to 4 line-purging valves can be controlled.

► motan Gruppe  
[www.motan-colortronic.com](http://www.motan-colortronic.com)

## Distribution Partnership for Mexico Entered

■ SONGWON Industrial announced that it has signed an exclusive distribution agreement with First Quality Chemicals, a leading specialty chemicals distributor in Mexico, for the coatings, adhesives, sealants and elastomers (CASE) markets.

Under the new agreement, effective August 2020, First Quality Chemicals will be the exclusive distributor for Mexico of SONGWON's comprehensive range of sustainable high-value, high-performance products: SONGNOX® CS antioxidants, SONGSORB® CS Ultraviolet Absorbers/ Hindered Amine Light Stabilizers (UVA/HAL) and SONGCURE® CS photoinitiators. First Quality Chemicals has been building its reputation as a reliable specialty chemicals distributor since 1998 and over the years has successfully solidified its leadership position in the Mexican market.

*(Photo: Songwon Industrial Co., Ltd.)*



Commenting on the new distribution partnership, Sean Steres, Sales Manager Americas, SONGWON Industrial Group said: "Joining forces with First Quality Chemicals in Mexico is another important step in advancing our footprint in the Americas and confirms SONGWON's commitment to the coatings industry in this region. We are confident that the expertise and valuable experience of the First Quality Chemicals' team will ensure that the needs of our Mexican customers are fully met and that the partnership will also open the door to new business opportunities for SONGWON."

"Representing SONGWON aligns with our drive to bring extraordinary solutions from world-class suppliers to this market," said Sergio Chinas, CEO, First Quality Chemicals. "SONGWON's high performance products and the expertise delivered by our great sales team is a recipe for success and we are delighted to play a key role in creating new business opportunities that enable us to continue growing together."

► First Quality Chemicals  
[www.firstqualitychemicals.com](http://www.firstqualitychemicals.com)

Songwon Industrial Co., Ltd.  
[www.songwon.com](http://www.songwon.com)

# In-House Rheology Lab Launched

■ Guill Tool has opened an in-house rheology laboratory, making it the only extrusion tooling manufacturer in the industry with such a capability. Seeking to obtain better results and minimize the time it takes between testing and production, Guill built its own rheology lab in their facility in West Warwick, Rhode Island, USA. The lab features several key machines that ensure optimum results, when testing materials, especially new compounds to be extruded. The testing equipment includes a Hybrid Rotational Rheometer, a Differential Scanning Calorimeter, and a Thermal Conductivity Meter.

Third-party testing facilities are typically not experienced in extrusion processes. Guill, however, can not only gather data the same way third-party testers can, but can also interpret that data as it applies specifically to extrusion. Likewise, third-parties simply supply data, not recommendations. Guill is now equipped to both test its customer's materials and work with them to create extrusion tooling that will give them a competitive edge. Accurate simulation and interpretation by extrusion experts greatly reduces the number of physical reworks needed, as the tooling has a greater chance of producing a good product at the outset. In-house testing also speeds up the turnaround on test results, reducing delays during the tool design process and offering better control over the processes and test parameters.

The new Guill rheology lab processes standard materials, custom formulae and it is equipped to mix materials.

TA Instruments Discovery HR-2 Hybrid Rotational Rheometer



These materials include plastics, thermoplastic elastomers, all types of rubber and silicone. Information from the lab is transmitted directly to the Guill engineering department via computer link for review by the design team. The lab will be offered for use by extruders and chemical formulators, among others in the industry.

Guill Tool & Engineering  
Bill Conley: [bconley@guill.com](mailto:bconley@guill.com), [www.guill.com](http://www.guill.com)

TA Instruments DSC-25 Differential Scanning Calorimeter



TA Instruments DTC-300 Thermal Conductivity Meter

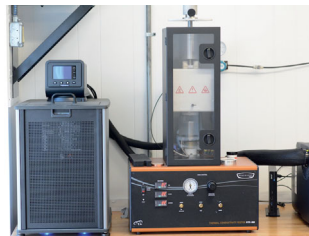

New Guill Rheology Lab at company headquarters in West Warwick, Rhode Island



## From the Simple to the Sublime

Series 800 crosshead for two to six layers

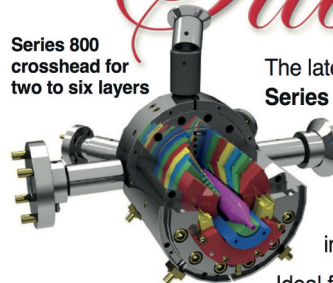

The latest generation of the Series 800 crosshead is designed to run two to six layer extrusions for high quality, high accuracy 1/8" to 6" OD tubing for medical, automotive, appliance and industrial applications.

Ideal for fluoropolymer multi-lumen, multi-layer tubing for fuel lines or thin layer combinations of polymers and adhesives to 0.02mm or less.

Features patented Guill Feather Touch® concentricity adjustment to eliminate leaking.

Please visit [www.guill.com](http://www.guill.com)

**Guill**  
EXTRUSION TOOLING

10 Pike Street  
West Warwick, RI 02893  
USA

[sales@guill.com](mailto:sales@guill.com) Attention: Bill Conley



# High-Speed Production Line for “Danish Trays”

*Highly modern 3-layer flat film sheet*



*“We always keep a step ahead of the market. We don’t do things by halves,” is the motto of Jacob Sørensen, Managing Partner of the Danish company Staal og Plast A/S. A glance into the production halls in Ringe impressively underscores his statement. Here stands the world’s largest thermoforming line with a footprint of 20 square meters, which transforms about 3 mm thick, extruded, HI-semi-finished PS sheet into what is known as ebb & flow trays for greenhouses/hothouses. To produce the up to 8 m long and 2.5 m wide semi-finished boards, battenfeld-cincinnati Germany, Bad Oeynhausen, installed an ultra-modern sheet extrusion line with throughput rates of up to 3,000 kg/h just under a year and a half ago*

In addition to the rising world population and the resulting added demand for flowers, shrub and vegetable seedlings for professional and amateur gardeners, fresh herb pots for modern kitchens and the increasing cultivation of cannabis are all contributing to the booming greenhouse/hothouse construction. The Danish company Staal og Plast supplies precisely this niche market with made-to-measure high-impact polystyrene (HIPS) trays. The company, founded in 1984 by the father of today’s Managing Partner, concentrated right from the beginning on greenhouse/hothouse products, which during the first years included steel profiles as well as plas-

tic trays, as the company’s name suggests. “Today, we process exclusively plastics, since we are convinced that this is our core competence”, explains Jacob Sørensen. “We are concentrating on what we can do best, which means on just one product.” Obviously a concept which makes sense, for the relatively small company with just 15 employees makes 60 to 70% of all sheet products required for greenhouses/hothouses worldwide. And the market leader continues to grow. This is why it increased its production capacity at the Danish facility fourfold with the installation of the high-speed line and established a subsidiary in Chicago/USA, equipped

with a thermoforming line to start with. “Especially in North America, there is an enormous demand for our so-called ‘Danish trays’. The reason is the increasing cultivation of cannabis, which is not only grown for medical purposes, but due to its legalization in several federal states also more and more in demand for leisure applications”, explains Jacob Sørensen, suggesting that he may further expand his overseas facility in the near future and install an extrusion line there, too. Until that time, the company will continue to transport its Danish trays to the United States to have them thermoformed locally. “This is the only way we can guaran-

tee our high quality standards to our customers."

#### High quality standards and ...

For the 3-layer sheet line from battenfeld-cincinnati installed in 2018, Staal og Plast first built an entirely new hall to house the line with a total length of 65 meters and also to provide enough space for the huge thermoforming machine and extra space for handling the largest boards, which measure 2,500 by 8,000 mm. In the new co-extrusion line, the high-speed extruder 1-75 T6.1 is responsible as main extruder for the total capacity of up to 3 t/h. It alone reaches an output of about 2 t/h for HIPS. High-speed extruders come with a very compact design and reach their enormous output rates with high screw speeds. The melt's residence time inside the extruder is long enough to achieve optimal homogenization, yet short enough to prevent mechanical or thermal damage and thus ensure optimal melt attributes. In Denmark, the high-speed extruder plasticizes the material for the main layer, with in-house scrap resulting from changeovers and cuttingstamping being added to the virgin material. The material for the outer layers of the 3-layer composite is provided by two 1-75 T2.1 co-extruders. These, too, are high-speed extruders, each reaching outputs of up to 500 kg/h. "The outer layer, which comes into contact with the plant pots, is a distinctive feature

of our trays. It is approved for food production as well as resistant to UV radiation and chemicals. We developed its formulation in cooperation with a Danish partner company", the Managing Partner emphasizes.

#### ... knowledge of customers' needs as success factors

While the requirements for food safety and UV-resistance of the outer layer are a matter of course for greenhousehothouse trays, the need for resistance to chemicals is a specific consequence of working with ebb & flow trays. These trays, on which the plant pots stand, are flooded at regular intervals with water containing the fertilizers needed by the plants. After a specific period of time, the water and the additives it contains are drained and returned to the tank. Naturally, the irrigation medium is recycled to minimize water consumption. "To ensure the correct dosage, the water is tested and replenished with fertilizers each time prior to flooding", Jacob Sørensen reports. He also knows that mobile table systems are today's trend for modern hothouses. In contrast to conventional rolling tables, which are still being used and can be pushed to and fro on a frame, the mobile tables can be pushed in every direction. This enormously facilitates handling for the operators. Staal og Plast offers the right trays for every type of greenhousehothouse in the desired size and, above all, in high quality. For

absolute flatness must be ensured as a prerequisite for even watering of every plant. Sørensen is confident: "Thanks to our know-how of more than three decades, our customers can rely on us", and he regards this as the main reason for his market success.

#### Set for further growth

"Although the market for ebb & flow trays is booming and we have a good order situation", says Jacob Sørensen, "at present we still have some free capacity on the new line." He can therefore well imagine that he could make polystyrene sheet as a service provider for other industries. Possible products are mono-layer, 2-layer or 3-layer boards in virtually any desired dimensions with thicknesses ranging from 2 to 5 mm, and even in different colors if desired by customers. By the way, most of the ebb & flow trays are gray. The equipment in Ringe includes another sheet extrusion line for this purpose in addition to the new line, as well as a total of four thermoforming lines. The new line has replaced the second older line since 2018 and, apart from its high capacity, its main advantage is its low energy consumption, about 40% below that of the old line. In addition to the extruders already described, the new line includes a 3000-mm-wide flat sheet die, a roll stack with three main rolls and three post-cooling rolls, as well as a roller conveyor with thickness gauge and longitudinal cuttingtrim saws. At the end, there is a crosswise-horizontal cutting device for the up to 8m-long boards and a stackerstraddle carrier. "The line from battenfeld-cincinnati has even exceeded our technical requirements. We are perfectly satisfied and well prepared for our customers' future enquiries", Jacob Sørensen states with pleasure, and concludes with a big word of praise: "Over recent years, battenfeld-cincinnati has been one of our most reliable partners."

*Precision calender with special high-performance rolls*

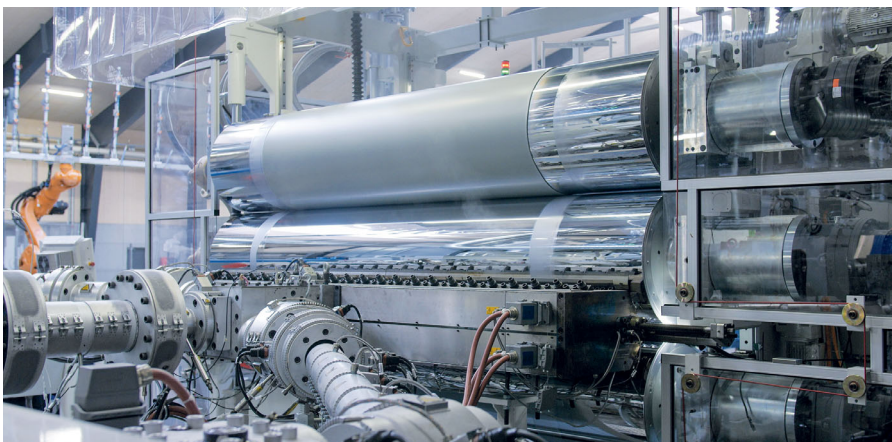

**battenfeld-cincinnati Germany GmbH**  
Grüner Weg 9,  
32547 Bad Oeynhausen, Germany  
[www.battenfeld-cincinnati.com](http://www.battenfeld-cincinnati.com)



*By Dr. Massimiliano Vailati (Tecnomatic SRL)*

*The market for polyolefin pipes is constantly evolving with more demanding customer and application requirements. Despite the constant improvement in polyolefin properties, single-layer solid wall pipes are still not able to always fulfil certain customer or application requirements. For such situations, multilayer pipes may be a solution. The key to producing a good multilayer pipe is the die-head. In this article will be showcased how Tecnomatic, a leading manufacturer of processing equipment for polyolefin and PVC pipes based in Bergamo, Italy continues to improve the technology and performance for the production of complex multilayer pipes with functional layers*

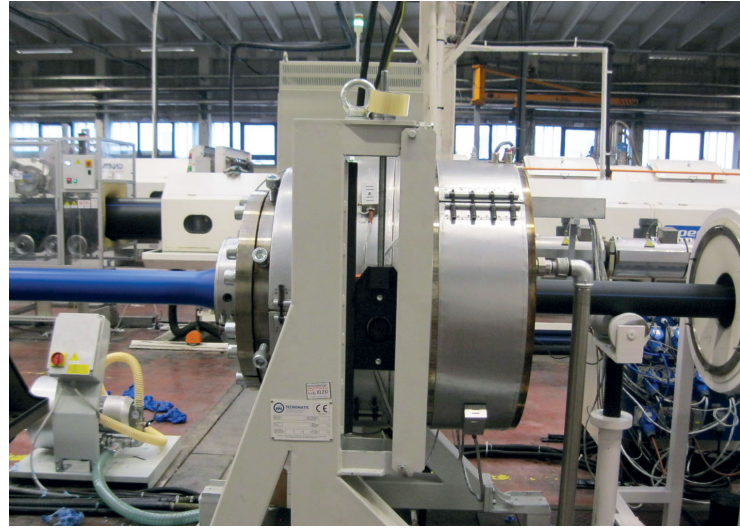

*Co-extrusion of HSCR PE100 using a coating die head on a standard PE100 pipe*

## Innovation and Enhanced Performance in the Production of Multilayer Pipes

Developed on the basis of the VENUS monolayer concept, Tecnomatic currently has a full range of die-heads with multi helical spirals, for the production of two, three or four layers polyolefin pipes, even for large diameters, building on years of experience supplying reliable and high performing lines for multilayer pipes. A recent delivery of a line to Authentic Production in Myanmar for the production of multilayer pipes up to 630mm shows that the Asia Pacific market is embracing innovations that may provide higher levels of performance.

*Multilayer 1200 mm OD PE100 with HSCR outer layer pipes being welded in Myanmar*



Authentic Production, part of the Authentic Group of Companies, which started its PE pipe production several years ago, has rapidly gained market share and reputation because of its focus on quality. They benefited from running Tecnomatic lines capable of producing pipes up to 1,200 mm that offered production efficiency, reliability and reduced scrap rates when producing their recently launched multilayer product. The new product featured the BorSafe™ HE3494-LS-H PE100 High Stress Crack Resistant (HSCR) material in the outer layer to offer their clients maximum security against point loads and surface damage that may occur during installation.

Such multilayer pipes have been used extensively in Europe for installations either using trenchless techniques or where no imported backfill is used. By using the same material dug from the trench, the installers were able to reduce the costs and environmental impact of bringing sand or other backfill materials to the site. HSCR PE100 pipes can now offer contractors and installers such options in Asia as well.

The wall of the multilayer pipe produced by Authentic Production is made up of two layers equal to 10 % and 90 % of the total thickness. The outer layer is produced from HSCR PE100 material and the core from standard PE100. This requires two separate extruders, which was achieved by a main extruder from the ZEPHYR series in L/D 40, which offers extreme output performance and lower melt temperature and energy consumption, while the inner layer is produced from an ATLAS series in L/D 30. Both extruders are synchronised



M.H. Aung,  
Authentic  
and  
Dr. Massimiliano  
Vailati,  
Tecnomatic



using gravimetric feed on each extruder to maintain a continuous raw material feed and to record variations in mass throughput, thereby ensuring perfect control of the weight per meter and wall thickness distribution.

The VENUS MULTI pipe head series have been designed to achieve excellent processing using a wide range of materials at very high output. The spiral geometry has been optimised for the latest generation of PE and PP raw materials, while achieving improvements in reducing its overall length, volume and operating pressure. The heart of the VENUS MULTI heads consist of an innovative flow channel geometry, which has been calculated to take into consideration the current raw materials. This geometry ensures the same behaviour for pressure and distribution of the melt, in all the pipe heads in the range even at very high output rates. This new feeding system, as well as for the matching ranges and the small die sets contributes to the reduced working pressure. This reduces the energy consumption during extrusion since up to 10 % of the extruder power is usually required for pumping capacity. Lower pressure results in a lower melt temperature and together with lower residence times ensures improved pipe characteristics such as its OIT (oxidation resistance) and reduction of thermal and shear stresses.

Authentic Production has expressed a high degree of satisfaction for the quality of the multilayer line since its commissioning. The new product will offer project owners additional

security for pipelines that are installed in demanding conditions. Additional features can be added to the pipe such as a peelable outer skin, which provides further economic and environmental benefits for water and gas distribution pipelines. This peelable outer jacket, frequently made from specially modified polypropylene, further protects the pipe surface against potential notches and cracks when using installation methods such as pipe bursting or wash-boring. Potentially deep scores in the protective jacket will not be transferred to the inner pipe when it is eventually exposed to service-related stresses.

The peelable jacket that is adhered to the outer wall of the core PE pipe is typically 0.6 to 0.7 mm thick for all current dimensions of this new multi-layered pipe and the skin is added by a cross-head positioned before the last cooling bath. Tecnomatic has a full range of die-heads, based on spiral or radial technology suitable for plastic or metal pipes coating ranging from 5 to 800 mm and up to 4 layers. The die-heads are based on a typical spiral technology for large and single layer co-extrusion or a mixed solution with radial distributors or short path spiral alternative depending on material characteristics such as PA, EVOH, PVDF or adhesive bonds.

Tecnomatic SRL  
Via Emilia, 4 – 24052, Azzano S.Paolo (Bg) Italia  
<https://tecnomaticsr.net>



VENUS 630  
die-head spiral  
distributor



ERGE Elektrowärmetechnik - Franz Messer GmbH  
 91220 Schnaittach - Hersbrucker Straße 29-31  
 Tel. +49/9153/921-0 Fax +49/9153/921-117  
[www.erge-elektrowaermetechnik.de](http://www.erge-elektrowaermetechnik.de)  
 mail: [verkauf@erge-elektrowaermetechnik.de](mailto:verkauf@erge-elektrowaermetechnik.de)



HEIZEN  
HEATING

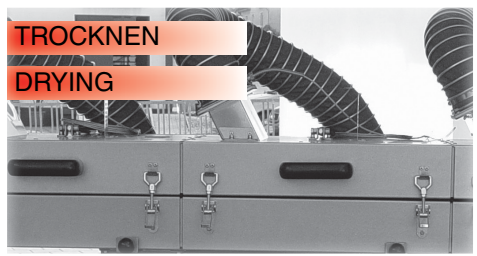

TROCKNEN  
DRYING

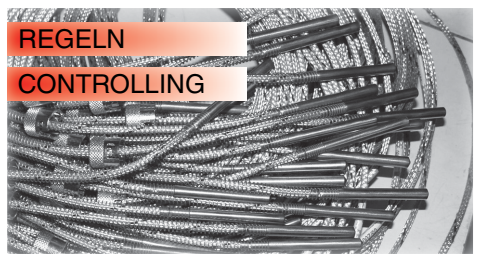

REGELN  
CONTROLLING

ELEKTROWÄRMETECHNIK FRANZ MESSER GMBH

*From bilateral teamwork with raw material suppliers, masterbatch specialists and film producers to more complex cooperations along the value chain: Brückner is involved at many levels*



*Brückner's pilot line was in the center of numerous development projects*

# Cooperations for a Sustainable Future – BOPE is at the Head of the List

DOW and Brückner are jointly developing BOPE-LLD and BOPE-HD resins and films as well as barrier solutions for BOPE (biaxially oriented polyethylene). All three fields of applications have been tested at Brückner in the lab-scale using the laboratory stretcher KARO 5.0® as platform for film developments as well as on the pilot line and successfully transferred to a production line.

The successful outcome of the cooperation with SABIC is a new BOPE-LLD material. Same procedure is now ongoing for BOPE-HD resins.

NOVA Chemicals has been working with Brückner to accelerate the development and commercialization of a new high-density resin technology for the BOPE market.

Besides BOPE-HD, Nova offers also BOPE-LLD grades.

The optimization of polymers, masterbatches and process parameters necessary for innovative BOPE films was carried out by CONSTAB engineers on the Brückner pilot plant. One example is white opaque BOPE film: By combining two innovative additive masterbatches, excellent density values of to 0.7 g/cm<sup>3</sup> were achieved, while at the same time providing very good stiffness.

In the "Circular Alliance" six companies teamed up to produce new high barrier mono material flexible packaging solutions designed for recyclability. The partners include Dow, a resin supplier, for the first step in the production chain, Brück-

ner Maschinenbau for the production of the biaxial stretched polypropylene and polyolefin-based films, Hosokawa Alpine for the production of MDO LDPE, ELBA to convert the finished film rolls into pouches, Constantia Flexibles to produce metallized high barrier stand-up pouches and finally Bobst with their high barrier, printing & lamination competence.

The project has involved using different high barrier mono-material structures, each one thoroughly tested to guarantee that all industry requirements were met in terms of processability, barrier, safety and optical quality. The different types of mono-material stand-up pouches (MDPE, BOPE, BOPP and



CPP) are the outcome of considerable investment and intense research by each of the partners.

In March 2019 a value chain project initiative was launched by a group of companies under the acronym PRINTCYC (Printed PP films for mechanical recycling) to research and test ways to create circular economy solutions basing on post-industrial waste. Members of PRINTCYC: The machine suppliers Brückner Maschinenbau, Kiefel and PackSys Global, the film producer Profol, the ink manufacturers Huber Group and Siegwerk, the converters Constantia Flexibles and Wipak as well as the recycling specialist Erema. The initiative is coordinated by akk innovation, an independent start-up company for sustainable innovation management in the plastics packaging industry. The specific target of the first two project phases was to understand the impact of

different ink formulations on the mechanical PP and PE recycling process. Furthermore, the re-usability of PP and PE recyclates made from printed post-industrial film waste was evaluated in cast film, blown film, compression moulding and thermoforming technologies as well as the biaxial stretching process.

R-Cycle is the open and globally usable tracing standard along the life cycle of plastic packaging. The overall goal is to implement a practical solution, ensuring recyclability by seamless documentation of all recycling-relevant packaging properties based on established technologies. In the recycling process, packaging can thus be precisely identified in order to process the resulting recyclate into diverse and high-quality plastic products. Partners in this project are: Arburg, Kautex Maschinenbau, Reifen-

häuser, Brückner Maschinenbau, the Institute for Plastics Processing (IKV) and GS1 Germany.

Last but not least and quite up-to-date, Brückner Maschinenbau researched and developed extensively in close collaboration with two long-standing customers in the direction of BOPE: With Bulgarian Plastchim-T and Portuguese Polivouga Brückner has been doing numerous joint trials at Brückner's technology center in Germany and the customers' production sites. Both film manufacturers then consequently took the next step: Each of them ordered an ultra-flexible BOPP/BOPE hybrid line for an extended range of films. Both lines will be in operation by the second half of the year 2021.

Brückner Maschinenbau GmbH & Co. KG,  
Königsberger Str. 5-7,  
83313 Siegsdorf, Germany  
[www.brueckner.com](http://www.brueckner.com)

## CONDUCTIVITY WITH PRECISION

**CABOT**  **CABOT**® conductive compounds and concentrates are tailored to meet the most demanding requirements in conductive plastics applications.

**CABOT**



To learn how our products can help you create innovative solutions, visit us at [cabotcorp.com/cabelec](http://cabotcorp.com/cabelec).

©2020 Cabot Corporation. The CABELECC name is a registered trademark of Cabot Corporation.



## 75 years of Buss Kneader Technology

20 August 1945, the day graduate engineer Heinz List filed a patent for the principle of the continuous kneader, is regarded as this compounding technology's birthday. Convinced by the concept, Buss AG inaugurated the first kneader test center in 1948 and delivered the first compounding systems for PVC and polystyrene in 1950, by which time List had become technical director. The company subsequently established this technology globally as the system of choice for producing compounds both efficiently and particularly gently

A glimpse into the process chamber of the current generation of COMPEO kneaders showing the position of the barrel-mounted kneading pins, which mesh with the flights of the modular screw shaft  
(© Buss)

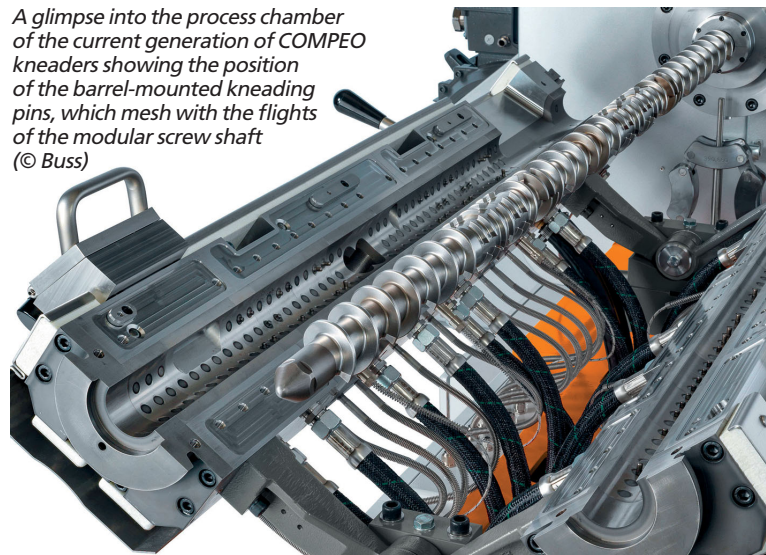

# Innovation and Enhanced Performance in the Production of Multilayer Pipes

To date, Buss has produced over 3,500 of these compounding systems in the form of customer- and application-specific solutions, exporting them to over 80 countries. Applications range from compounding high-performance engineering polymers with temperature- or shear-sensitive components, such as electrically conductive carbon blacks with filler contents as high as over 90%, to the production of formulations for the aluminum, chemicals and food processing industries. Buss's current range of compounding extruders for the plastics and elastomer industry includes the COMPEO series, which is available in six sizes and is capable of processing up to 12,800 kg/h of thermoplastics.

### The key to success

The highly effective and simultaneously gentle mixing action is the result of the particular way the Buss Kneader works. Firstly, its screw helix has two to four gaps per turn, which give rise to the characteristic flights which mesh with stationary kneading pins mounted in the barrel. Secondly, the screw shaft simultaneously rotates and axially oscillates, performing a complete forward and backward stroke from its starting position per revolution.

The shear required for melting and dispersion arises in the shear gap between screw flights and kneading pins. Based on the working principle, the shear rate is independent of machine size and is directly proportional to the rotational speed of the screw shaft. This explains a further advantage of the Buss Kneader technology, the straightforward scalability from lab to production scale.

### Increasing variety of applications

For many users who handle a wide range of products, the Buss Kneader is the system of choice thanks to its all-round capabilities. It has also become a technology leader in specific niche areas. For instance, manufacturers of insulation for medium to ultra-high voltage cables by reactive extrusion appreciate its precise temperature control. In semi-conductive compounds, the gentle dispersion of highly structured additives is key, while in other thermoplastics the decisive factor is compounding within tight processing windows.

Applications in medical technology include the production of compounds for handling liquids and for sterile packaging for medicines, of compounds with antibacterial and antiviral properties and of adhesives, for example for dressings. The Buss Kneader's moderate shear rates combined with very good mixing characteristics mean very small quantities of additives can be uniformly incorporated.

In applications involving temperature- and/or shear-sensitive ingredients, for example in compounds based on PBT (polybutylene terephthalate) or high-temperature-resistant polyamide (PA), in thermosets which have to be compounded below crosslinking temperature, or in natural fiber-reinforced materials, the moderate shear rates mean compounding can be carried out within tight operational windows. Applications range from electronic components via under-hood parts to weight-optimized aircraft or vehicle parts.

**BUSS AG**  
Hohenrainstr. 10, CH-4133 Pratteln, Switzerland  
[www.BUSScorp.com](http://www.BUSScorp.com)

# Advantageous Production of Full PO Films

## Kuhne Anlagenbau presents its proven Triple Bubble® technology for recyclable barrier films

*Mono material film structures is the name of the modern solution for all packaging applications that require both high performance and environmental friendliness. However, the production of full PO films poses challenges for plastics processors: they have to adapt and expand their manufacturing equipment and meet all the requirements of the food industry. With its Triple Bubble® technology, Kuhne Anlagenbau GmbH from St. Augustin, Germany, now offers an ideal solution to all film manufacturers for the economical production of uniformly oriented mono-material films that are both high quality and directly sealable*



“We have been building Triple Bubble® blown film lines for over 20 years and thus have an enormous wealth of experience both in terms of machine technology and formulation development,” emphasizes Jürgen Schiffmann, Managing Director of Kuhne Anlagenbau GmbH. “We have now transferred this know-how advantage to five-layer full polyolefin film structures and are thus offering an alternative that has many advantages over conventional blown film lines with MDO stretching units”.

Kuhne Anlagenbau carried out these developments in its in-house technical center, which has a modern but small 13-layer triple-bubble R&D line with an output of around 250 to 300 kg/h for a maximum double film width of 900 mm. During the extensive tests, the machine technology for manufacturing the five-layer structures was optimized and suitable formulations were tried out. The result is a uniformly oriented film, optionally as a full PE or full PP barrier film structure. The main advantages of these film structures are their sealability and their waste-free, and thus more efficient and environmentally friendly, production.

Nowadays there are only a few packaging solutions without a barrier function, especially when it comes to the packaging of food or pet food. “The term mono-material structures is somewhat misleading,” explains Jürgen Schiffmann, “because all commercially available full PO films contain up to five percent foreign material in order to achieve the desired barrier properties.” In detail, this is what the Kuhne solution looks like: The sealing layer consists of commercially available sealing materials such as metallocene PE or plastomers, the inner EVOH barrier layer is enclosed by two PE-based tie layers and an HDPE blend is used for the outer layer. “With the same line configuration, we can also produce a mono PP film without any modification,” emphasizes Jürgen Schiffmann. The technology is just as flexible in terms of the film thickness, which can vary between 15 and 150 µm, and in terms of the film properties. Film shrinkage is also adjustable, depending on whether the film is to be used for stand-up pouches, coffee and snack packaging, which require non-shrinkable films or for lid films, which require slightly shrinkable films. For bottom web film in the food

packaging sector, the films can also be designed to be thermoformable and even deep-drawable and shrinkable for form-shrink applications.

Since the films are produced using the Triple Bubble® technology they have the same properties and thickness over the entire circumference, so that neither a neck-in nor an edge trim occur. In the first bubble the film tube is rapidly quenched with water in order to achieve ideal amorphous properties, in the second bubble simultaneous biaxial orientation is imparted and in the third bubble the annealing takes place.

An ecological solution. The solution from Kuhne Anlagenbau also eliminates the need to laminate an MDO film with a sealing layer, which is usually necessary. “Our films are directly sealable and can be processed further,” says Jürgen Schiffmann, adding another economic and ecological argument for the production of mono-material film structures with Triple Bubble® technology.

■ Kuhne Anlagenbau GmbH  
Einsteintr. 20,  
53757 Sankt Augustin, Germany  
[www.kuhne-ab.de](http://www.kuhne-ab.de)

*Breathable sports and outdoor clothing are in vogue. Combined with the “fast fashion motto” and the “mass instead of class principle”, this is creating increased demand for PET fibers worldwide. This, in turn, leads to an increase in production waste, as this is automatically generated during fiber production. For ecological and economic reasons, the fiber residues must be appropriately processed and reused, which in some cases poses major challenges for fiber manufacturers and processors. Several customers, including large fiber manufacturers in China and Belarus, have therefore decided to use key components from Gneuss Kunststofftechnik in Bad Oeynhausen, Germany. With these they were able to convert existing fiber lines with low investment costs, so that the complete fiber waste can be processed into high quality fibers. And this is even possible for the production of drawn yarns such as POY or FDY, where the use of recycled material has up to now not been possible*



*Shot taken during the installation of an MRS extrusion line at Suzhou Shenghong Fiber Co. Ltd, Jiangsu province, P.R.China*

## PET Fiber Production – Zero-Waste Cycle Thanks to Retrofitted Components

In the past 20 years, total textile production has doubled, and from 2000 to 2016, the use of polyester for clothing alone rose from 8.3 to 21.3 million tonnes worldwide. At the same time, the public's call for the avoidance of plastic waste is becoming louder and legal directives of the European Union are intended to put a stop to plastic waste. For example, in addition to the collection of plastic, glass, paper and metal, a separate collection system for textiles is to be implemented in all EU countries by 2025 to enable high-quality recycling. In addition, product manufacturers are being made more responsible through the environmental protection strategy of Extended Producer Responsibility (EPR). They are to ensure the entire life cycle of their product from manufacture to disposal so that goals such as ecological design and resource efficiency can be achieved more quickly. In addition to the

recyclability of products, the use of recycled materials is one way to achieve these goals. However, this is precisely where problems often arise:

The demand for the increased use of recycled materials in textiles requires a sufficient and regular availability of these materials. Well available on the market is the recycled PET from beverage bottles, which is available in very good quality due to the clean collection systems. However, the increased use of r-PET, especially for packaging applications and textile fiber production, has led to a strong increase in demand in recent years, so that in addition to the increased market price, other recycled materials must now be used.

### **Possible retrofit of key components**

Production processes that were previously designed only for the processing of virgin material and thus achieved consistently high qualities under known conditions, are now severely disturbed or interrupted by contamination and strongly fluctuating material qualities at a higher recycling rate. Constant mechanical properties and uniform dyeability of the fibers or special requirements such as very fine fibers or use in direct body contact can no longer be achieved with the existing production lines. Therefore, plants are required which on the one hand can process recycled material – even in lower quality – and on the other hand can generate a high-quality end product without impurities. This is exactly where the German company Gneuss comes in with its machine com-

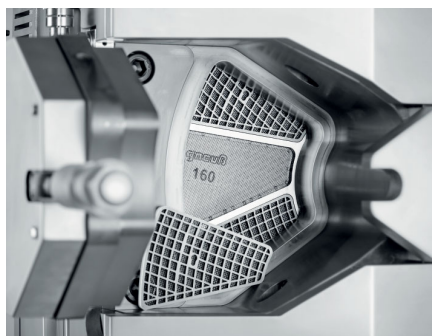

*Filter disc and filter elements of the fully automatic Rotary Filtration System RSFgenius*



ponents for PET processing. The MRS Extruder with its high degassing and decontamination performance, powerful and automatically operating Rotary Filtration Systems, an On-line Viscometer as well as the Polycondensation Unit Jump, which can ensure a targeted viscosity build-up of the PET melt of up to 0.3 dl/g, are available. Each of these machine components is available individually or in combination and can be retrofitted into an existing production line to adapt it to the changed requirements. In this way an ideal result can be achieved with comparatively low investment costs.

### Main component MRS Extruder

The extruder has a special task when processing PET fiber residues, since the plastic must not only be melted and homogenized, but if possible, also dehumidified and freed of volatile components if possible. While post-consumer waste can contain mainly moisture and a wide variety of solid dirt particles, production waste from fiber manufacture usually contains spinning oils, which are important for processing but make recycling more difficult. Regardless of which form of thermal cleaning of the waste material is required, the Multi Rotation System Extruder from Gneuss Kunststofftechnik takes over this task.

This is due to its special processing-technical design based on a single-screw extruder. Thanks to the enormously large melt surface created in the multi-screw section of the extruder, a high degassing and decontamination performance can be achieved and spinning oils can be effectively removed. No thermal pre-treatment of the residues is necessary. Among others, this was a good reason for the Belarusian processor Mogilevkhimvolokno located in Mogilev, one of the largest Eastern European producers of staple fibers, to retrofit an MRS 90 to its existing line. With a capacity of around 350 kg/h, all agglomerated fiber residues arising in production are processed, decontaminated and then re-polymerised to PET with a defined IV value in a polycondensation reactor without any further preparation. The situation is similar at the Chinese fiber producer Suzhou Shenghong Fiber Co. Ltd which operates an MRS 130 with a capacity of up to 800 kg/h. Here, too, the fiber waste is first shredded, melted in the MRS and thermally cleaned before it is brought back to the desired IV value in the polycondensation reactor and then processed into POY and FDY yarns. For the first time, stretched fibers with a high recycled content can be produced in this way.

MRS extruders are in use worldwide for processing PET waste materials. This is also the case with the South Ameri-

can company Valerio, which operates an MRS 90 with a capacity of 450 kg/h to produce staple fibers from very dirty bottle flakes.

### Mechanical cleaning indispensable

Especially when using heavily contaminated bottle flakes, as is the case with the South American Gneuss customer, mechanical melt cleaning is indispensable. Valerio decided in favour of an RSFgenius 90 which, like all melt filtration systems from Gneuss Kunststofftechnik, operates with a rotating filter disc.

Especially in recycling applications, low material losses and infrequent filter element changes are important in order to ensure a high efficiency of the overall process. Therefore, the RSFgenius not only operates pressure- and process-constantly, but also carries out the cleaning of the filter elements fully automatically by means of an integrated back-flushing system. For this purpose, a small amount of filtered melt is regularly shot through the dirty screen by a high-pressure impulse over a narrow gap. The quantity required for this is freely adjustable and in practice corresponds to about 0.01 to 1 % (with very high contamination) of the throughput. This means that the filter elements can be reused up to 400 times, depending on the filter fineness, which means fully automatic filtration without the need for personnel for several weeks in some applications.

Even the two major fiber producers in Belarus and China are convinced by the machine component "filtration system", which is also available as a separate unit and can be integrated into any existing line. They use an RSFgenius 90 resp. an RSFgenius 175 according to their throughput capacity and thus ensure a clean melt. This is especially essential for fiber production, as foreign particles could clog the spinneret and cause fiber breakage, which in turn would greatly reduce production efficiency.

### Further key components available

With its enormous know-how in PET processing, Gneuss not only advises its customers – which is very important especially for retrofit solutions – the machine manufacturer is always working on the further development of its machine components. In addition to the online viscometer, which records and controls the melt viscosity during production and, via a control system, readjusts the entire process in case of fluctuating viscosity, the polycondensation reactor Jump is one of the latest new developments. It is flanged directly to the extrusion unit and, with its sophisticated processing-technical concept, ensures a targeted viscosity build-up of the PET melt. The Jump thus represents a compact, economical and fast alternative to conventional SSP systems and enables the direct return of the residual materials into the production process. It can also be retrofitted to an existing line at any time.

► Gneuss Kunststofftechnik GmbH  
Moenichusen 42, 32549 Bad Oeynhausen, Germany  
[www.gneuss.com](http://www.gneuss.com)

*Polyreactor JUMP for flexible IV increase and adjustment*



*One of Aleko Machinery customers set a task: to invent a machine, which is able to produce a high quality film from low cost biodegradable raw material. At the time of the order, the customer had already produced such film, but on extruders designed for LDPE/LLDPE processing. Experience has proven that, not every such machine copes well with the task due to the screw design, which is not quite adapted for biodegradable material processing. To solve the problem, the Aleko design office has developed an extrusion line "Aleko Bio". It makes possible to produce high quality thin film from inexpensive biodegradable raw material with high capacity*



## The Task Is: To Produce High Quality Film from Low Cost Biodegradable Raw Material

For the first time this model of extrusion line was presented at K 2019 Fair where, even under the conditions of the exhibition, the company received an excellent film with a thickness of 8 microns from both low-budget biodegradable materials (Gemabio F2910) based on corn starch, and more expensive one (BASF ecovio F23B1).

During the development process, Aleko Machinery specialists carried out a large number of tests of various types of biodegradable raw materials in order to take into account all the bottlenecks that arise when using low cost biomaterial in production during the design of the extruder. However, affordable biodegradable polymers are especially sensitive to temperature conditions and pressure inside the material cylinder, the peculiarities of melting, viscous flow and crystallization of polylactide so they impose some special requirements on extrusion equipment.

When the melted material overheats, this results into burnout of the material followed by smoke emissions and low quality final product in the end with unsatisfactory strength characteristics, increased thickness and unattractive appearance. In addition, degradation products of biomaterials can lead to depositions in material cylinder or in die causing defected final products.

The advantage of this extrusion line is the special extrusion unit. Having the specially designed screw for Aleko Bio, the company used their own know-how, thanks to which the melt material flows inside the barrel extremely delicately during the extrusion process. Also, after calculating the optimal time for the melt to stay inside, it was decided to double

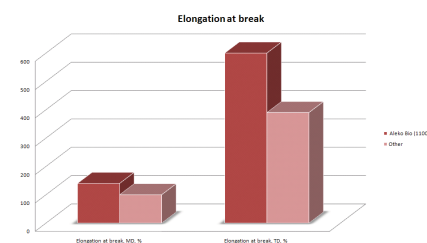
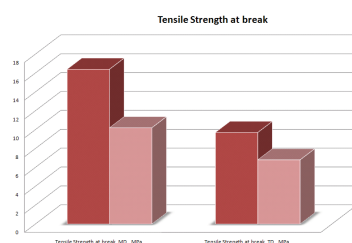

Biodegradable raw material Gemabio F2910					
Extrusion line	Film thickness, mcm	Tensile Strength at break, MD, MPa	Tensile Strength at break, TD, MPa	Elongation at break, MD, %	Elongation at break, TD, %
Aleko Bio (1100)	10	16,4	9,7	140	600
Other	10	10,2	6,8	100	390

Biodegradable raw material BASF ecovio F23B1					
Extrusion line	Film thickness, mcm	Tensile Strength at break, MD, MPa	Tensile Strength at break, TD, MPa	Elongation at break, MD, %	Elongation at break, TD, %
Aleko Bio (1100)	10	32,8	17	140	630
Another machine	10	24,5	15,2	110	540

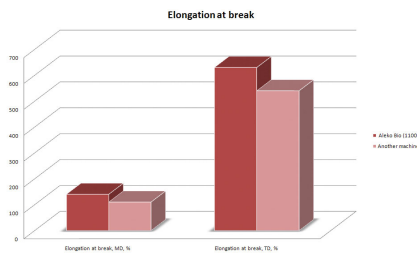
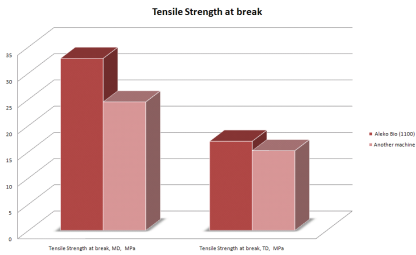

the number of material inlet channels in the die in order to reduce the possibility of material burning. As a result, Aleko developed an extrusion unit of the blown film line, where there is no thermal-oxidative

destruction of the "capricious" biodegradable material, which means that the resulting film can boast high quality, with high tearing strength. Testing of this blown film extrusion line showed excellent results. Us-

ing inexpensive biodegradable raw material production Gemabio F2910 (corn starch), Aleko Bio, with no loss in film quality, provides capacity of up to 220 kg/h with 65 mm screw and 200 mm die head diameter. As already mentioned, the tests were carried out on large amount amount of biodegradable materials. Two of them: more expensive (BASF ecovio F23B1) and more affordable (Gemabio F2910) (see graphics). Aleko Machinery is ready to show the results of testing Aleko Bio on the customer's raw material. The customer can send 200 kg of their biodegradable material and get back ready film with excellent quality, which can be checked by the customer himself.

Aleko Machinery  
www.en.polimerexpert.ru





[www.en.polimerexpert.ru](http://www.en.polimerexpert.ru)



**RUSSIAN MANUFACTURER OF  
POLYMER PROCESSING EQUIPMENT**

- ✔ High Speed blown film line working with Biodegradable raw material «ALEKO BIO» (film thickness from 8 mcm, 220 kg/h)
- ✔ High Speed HDPE blown film line ALEKO TURBO (HPDE, 200 m/min, film thickness from 5 mcm)
- ✔ Multilayer Coex blown film lines ALEKO (3-layer, 5-layer, ABC, ABA)
- ✔ Automatic film thickness control systems
- ✔ Gravimetric and volumetric dosing systems
- ✔ Extrusion control systems

+7 (863) 261 88 88
 info@polimerexpert.ru
 Rostov-on-Don, Russia



# Noryl PPX Polymeric Blend and Natural Polypropylene

By Jean Zolet

*With the increasing cost of Noryl PPX, a blend of phenylene polyoxide with polypropylene, supplied exclusively by a single company, monopoly in the manufacture of this polymer in the world, the need arose for the development of a new material, where a greater amount of virgin polypropylene will be added to Noryl PPX, forming a new polymer blend with the main objective of cost reduction. The studies seek to analyze the possibility of implementing this blend in the production process based on physical and chemical tests, in the study of miscibility and compatibility as well as the cost of the materials involved and processing. The present research aims to formulate Noryl PPX blends with natural polypropylene, at a competitive cost in the polymeric materials market, which maintains similar properties and characteristics of the pure Noryl PPX material, currently used in bus bumpers*

The development of this new material will provide continuity in the manufacture of many products that today are manufactured with excellent performance and market acceptance, however, due to the economic impossibility due to the high cost of pure Noryl PPX, the replacement of this material by other engineering polymers is contemplated.

**Table 1 - Composition of polymers (%) in the preparation of blends**

POLYMER COMPOSITION (%)	
Noryl PPX	Polypropylene
100	0
0	100
70	30
60	40
50	50

**Table 2- Injection parameters**

Parameters	Pressure	Velocity	Final pos.
Quick close 1	80	80	170
Quick close 2	40	60	25
Mold Prot.	5	55	2
High Pressure	130	55	
Slow Open	40	50	50
Quick Open	50	70	100
Quick Open	20	60	150

## Methodology

In obtaining the Noryl PPX and Polypropylene blends, the following polymers were used: Noryl PPX and Natural Polypropylene. The preparation of the blends followed the technique of mechanical mixing, performed directly on the brand injection machine, Sinetron SYA 900DT thread D = 40, by injection process. The polymer mixture was processed by heating and shearing the materials, inside the injector cannon, the same process normally used on an industrial scale. Table 1 shows the percentage of each polymer in the blend composition. 6 mm thick plates were produced by the extrusion process and subsequently processed by thermoforming in the molding of bus bumpers.

For the injection of the samples, the injection parameters were used according to Table 2.

## Results

The blending results are presented and discussed below:

70% Noryl PPX + 30% Polypropylene

60% Noryl PPX + 40% Polypropylene

50% Noryl PPX + 50% Polypropylene

The results will always be compared with the performance of the original Noryl PPX material.

The results obtained through mechanical tensile tests can be verified and compared according to Table 3.

**Table 3 - Tensile tests**

Comparison of the tensile tests of the studied materials			
Material	Maximum stress (MPa)	Elongation at break (%)	Modulus of elasticity (MPa)
Noryl PPX pure	26,49 ± 1,43	104,2 ± 16,0	1947 ± 111,0
Polymer blend 70% Noryl PPX + 30% PP Nat.	22,76 ± 0,59	230,9 ± 87,0	1364 ± 227,0
Polymer blend 60% Noryl PPX + 40% PP Nat.	23,58 ± 0,23	270 ± 16,1	1543 ± 169,0
Polymer blend 50% Noryl PPX + 50% Polypropylene	25,21 ± 1,35	153 ± 105,0	1759 ± 238,0
Pure polypropylene	26,55 ± 2,37	82,69 ± 66,0	1904 ± 288,0

**Table 4- Impact tests**

Comparison of Izod impact tests of the materials studied		
Material	Thickness (mm)	Impact J/m
Noryl PPX pure	3,22	437,4
Polymer blend 70% Noryl PPX + 30% Polypropylene	3,23	423,2
Polymer blend 60% Noryl PPX + 40% Polypropylene	3,23	412,1
Polymer blend 50% Noryl PPX + 50% Polypropylene	3,27	403,4
Pure polypropylene	3,26	382,3

**Table 5 - Differential scanning calorimetry tests**

Crystalline fusion temperature values		
Material	Tm	ΔH
Noryl PPX pure	162,0°C	12,59 J/g
Polymer blend 70% Noryl PPX + 30% Polypropylene	165,0°C	27,36 J/g
Polymer blend 60% Noryl PPX + 40% Polypropylene	165,3°C	29,63 J/g
Polymer blend 50% Noryl PPX + 50% Polypropylene	165,1°C	33,45 J/g
Pure polypropylene	166,8°C	45,71 J/g

As the polypropylene is added it was verified that the maximum tension of the blends increases, the elongation decreases and the modulus of elasticity increases, this behavior can be attributed to the degree of crystallinity of the polypropylene, however the results are inferior to the initial materials, (Noryl PPX and natural polypropylene).

On an industrial scale, a tensile test was performed on the blend 50% Noryl PPX plus 50% Polypropylene and on pure Noryl PPX, the specimens were removed from a 6 mm extruded sheet.

We can observe that with the addition of 50% polypropylene in the middle of pure Noryl PPX, there is a great increase in maximum tension, the elongation shows a significant reduction and the elasticity module increases considerably due to the high crystallinity of the polypropylene.

Results obtained through mechanical impact tests can be compared according to Table 4.

The behavior of the blends in relation to the impact toughness property follows the same logic obtained in the tensile tests, as polypropylene is added in different proportions, the impact resistance is reduced due to the increase in the degree of crystallinity.

The analysis of the results obtained through thermal differential scanning calorimetry tests (Table 5) demonstrated an increase in the degree of crystallinity of the blends as the polypropylene was added.

They are used as criteria for evaluating the miscibility in a blend, obtaining a single glass transition (Tg) and

or changes in crystalline fusion temperatures (Tm). The immiscible blends have more than one Tg, the miscible ones have a single Tg and a single Tm and the partially miscible ones contain values close to that of pure polymers (QUENTAL, et AL., 2010). The first material tested was pure polypropylene (Figure 1).

It was observed that the polypropylene showed a Tm evidenced by a large peak that proves the high degree of crystallinity of this polymer.

The second sample analyzed was composed of 30% polypropylene and 70% Noryl PPX (Figure 2).

There was a significant drop in the degree of crystallinity of the material due to the high Noryl PPX index in the blend composition.

The third blend analyzed was composed of 40% polypropylene and 60% Noryl PPX (Figure 3).

This has a Tm of 165 °C, and a small increase in the degree of crystallinity.

The fourth sample that was analyzed was composed of 50% polypropylene and 50% Noryl PPX (Figure 4).

It was found that the blend presented Tm around 165°C, with a high degree of crystallinity due to the proportion of 50% polypropylene.

The last sample analyzed was pure Noryl PPX (Figure 5).

Figure 1: DSC Graph – 100% Polypropylene

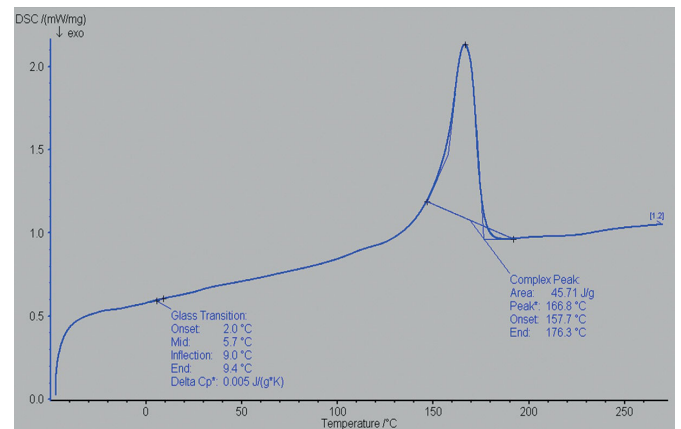
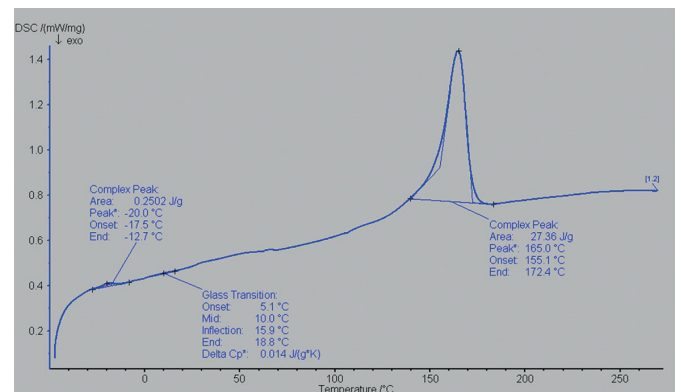

Figure 2: DSC Graph – 30% Polypropylene 70% Noryl PPX



There was a small reduction in the Tm of the material to 162°C, and a large reduction in the degree of crystallinity.

In the sequence, the enthalpy results of the materials are shown in the DSC tests (Figure 6), degree of crystallinity (Figure 7) and a graph with a theoretical study of the behavior of other proportions of the same mixture based on the results already obtained.

### Conclusion

Based on the results of the studies carried out, it was concluded that the blends studied presented an excellent performance. The compatibility and miscibility were

Figure 3: DSC Chart – 40% Polypropylene 60% Noryl PPX

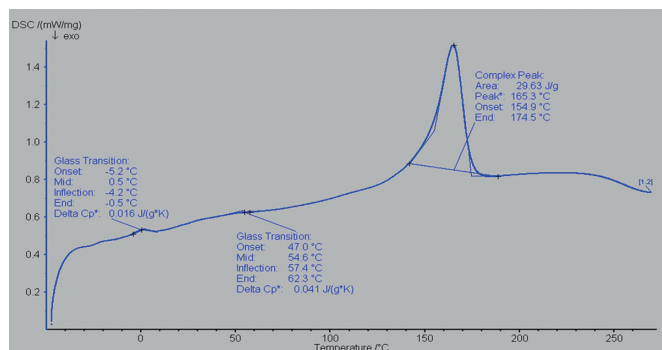

Figure 4: DSC Graph – 50% Polypropylene 50% Noryl PP

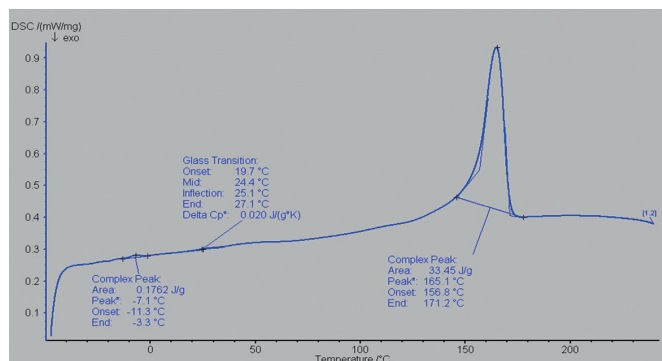

Figure 5: DSC Graph – 100% Noryl PPX

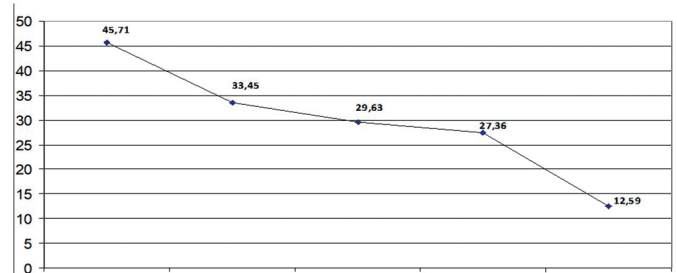
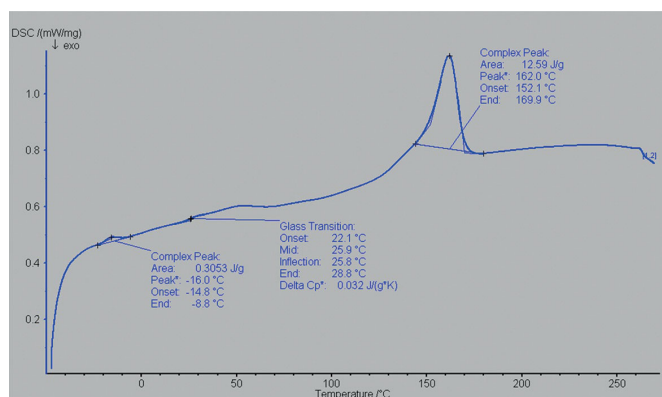

Figure 6: Graph for comparison of enthalpy of crystalline fusion of the materials

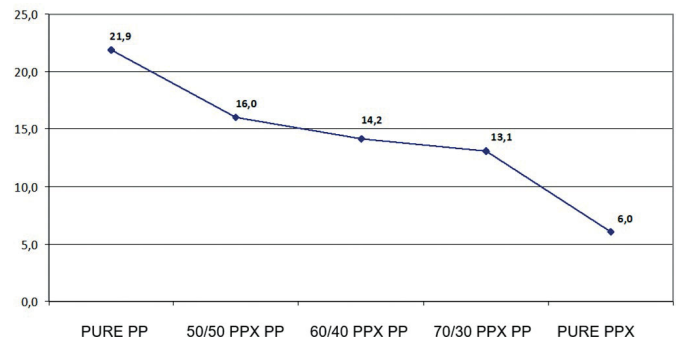

Figure 7: Graph for comparing the crystallinity of the materials (%)

proven through the DSC test and the variations in properties were small and acceptable for the applications where the blends can be used.

During the processing of the materials, to manufacture the specimens used in the tests, there was an interesting homogeneity between the materials, without any problems in their processing. The studied blends: 70/30 and 60/40, and 50/50, presented satisfactory performance in all aspects studied.

Considering the results, the technical, structural and functional part, it is possible to use all proportions, in the substitution of the Noryl PPX for making shocks for buses. The 50/50 blend stands out for presenting the most competitive cost among the blends studied, when compared to the cost of pure Noryl PPX, with this new material, we will be able to bring again the long-awaited economic viability to the manufacturers of products that are currently produced with 100 % Noryl PPX pure.

In the mechanical tests, the 50/50 blend had a performance very close to the pure Noryl PPX, showed a reduction in viscosity and a significant increase in crystallinity due to the increase in the proportion of polypropylene.

### The Author:

*Jean Zolet is an engineer specializing in polymeric materials. At the age of 39, Jean Zolet lives in the city of São José dos Pinhais, in the Brazilian state of Paraná.*



# PLAST<sup>®</sup> IMAGEN



## MEXICO 2021 11-14 JANUARY

Centro Citibanamex / Mexico City

EXHIBITION FLOOR  
REGISTRATION IS FREE  
FOR INDUSTRY  
PROFESSIONALS

Sponsor Registration



PLASTIMAGEN<sup>®</sup> MÉXICO 2021, the most comprehensive and important exhibition of the plastics industry in Latin America, is where you will find the latest in **INNOVATION, TECHNOLOGY AND SOLUTIONS**, with **870 exhibitors** representing more than **1600 brands**, **14 international pavilions** and 1 pavilion of the National Association of Plastic Industries in Mexico (**ANIPAC**).

The exhibition floor covers more **40,000 m<sup>2</sup>** displaying the latest in Machinery / Equipment, Raw Materials, Transformers, and Various Products / Services for the Plastic Industry.

The plastics sector has become a key element in human development. Its contribution has helped to strengthen sectors that are now essential across the globe, including automotive, aerospace, consumables, electronics, medical devices, agriculture, civil engineering, and many more.

This is **THE PREMIER EVENT** if your company is looking for solutions in: Extrusion, Injection Moulding, Blow Moulding, Rotation Moulding, and Thermoforming, among many others.

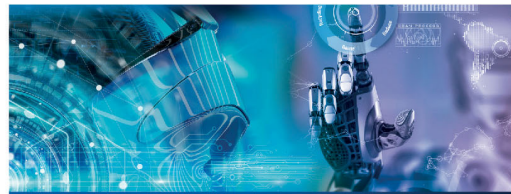

We look forward to seeing you at  
**PLASTIMAGEN<sup>®</sup> MÉXICO 2021!**

Plastimagen @plastimagen plastimagenmx

# www.plastimagen.com.mx

Silver Sponsor:



Organized by:



Certified by:



Member of



Supported by:



Venue:



# SMART EXTRUSION

The only website collecting information about smart technologies of extrusion

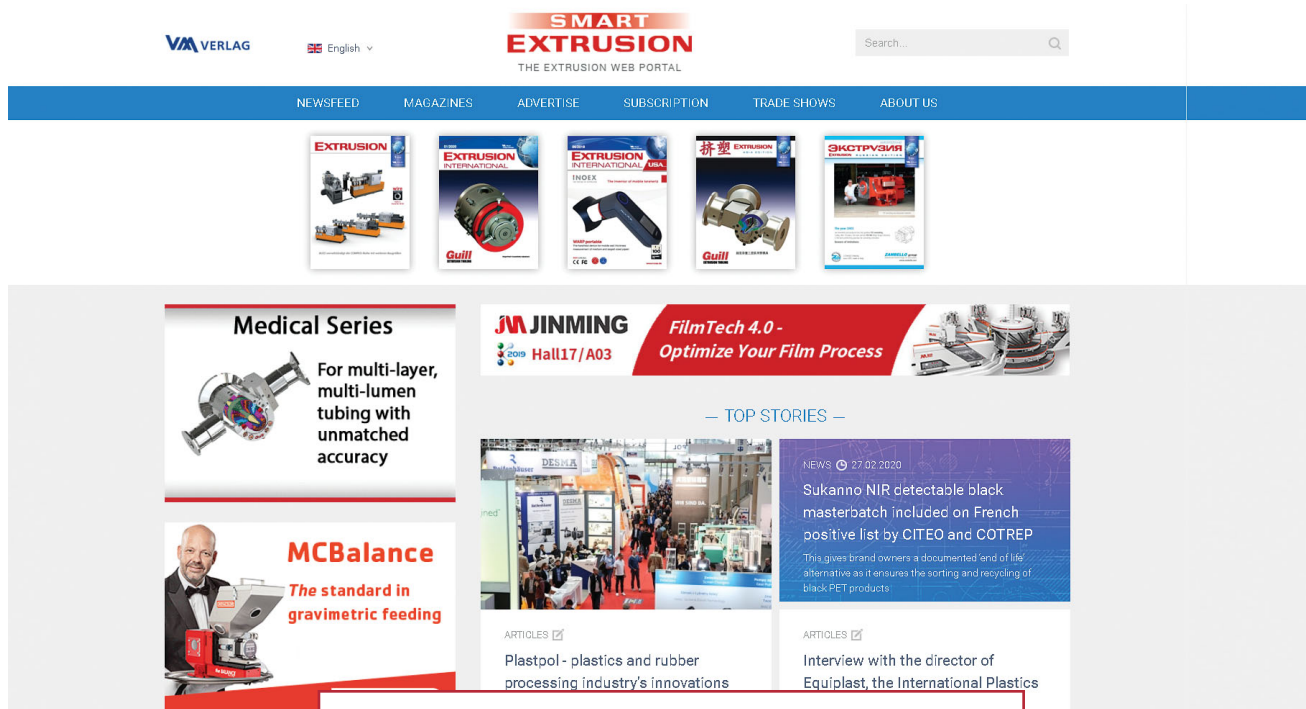

## A SPECIALIZED WEB PORTAL

-  News about relevant products and events
-  Video clips demonstrating smart equipment in live action
-  Detailed reviews of various smart technologies
-  Latest magazines available for reading and downloading
-  Case studies from processors
-  Weekly e-mail newsletters
-  English, German, Russian and Chinese

**34 600 + average monthly visits**

Geographic distribution of Smart\_Extrusion readers, %

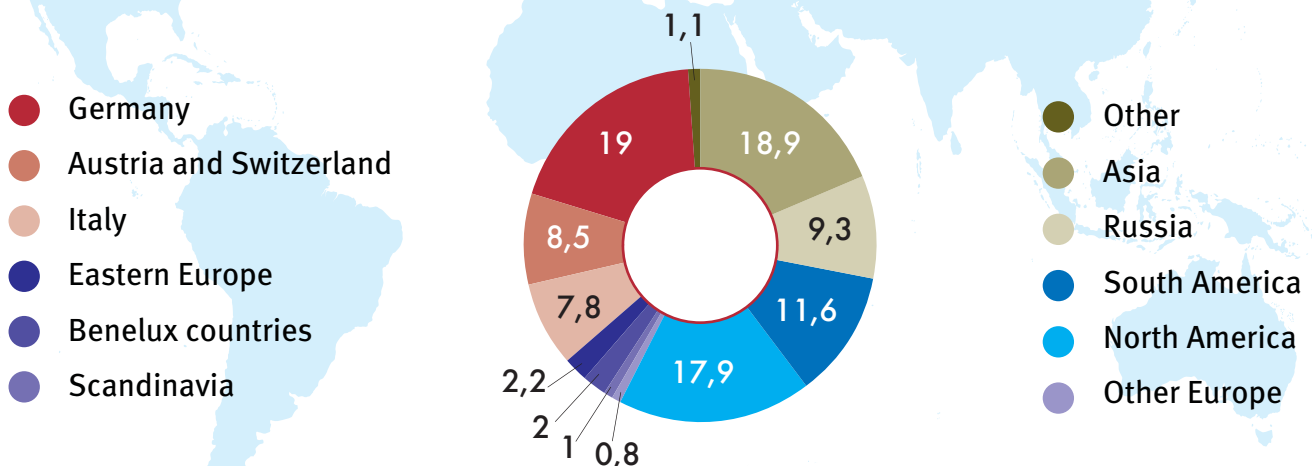

[www.smart-extrusion.com](http://www.smart-extrusion.com)