

05/2021

VVA VERLAG
Cologne /Germany



EXTRUSION INTERNATIONAL

ECON

**ECON UNDERWATER
PELLETIZING
SYSTEM**

LIVE DEMONSTRATION

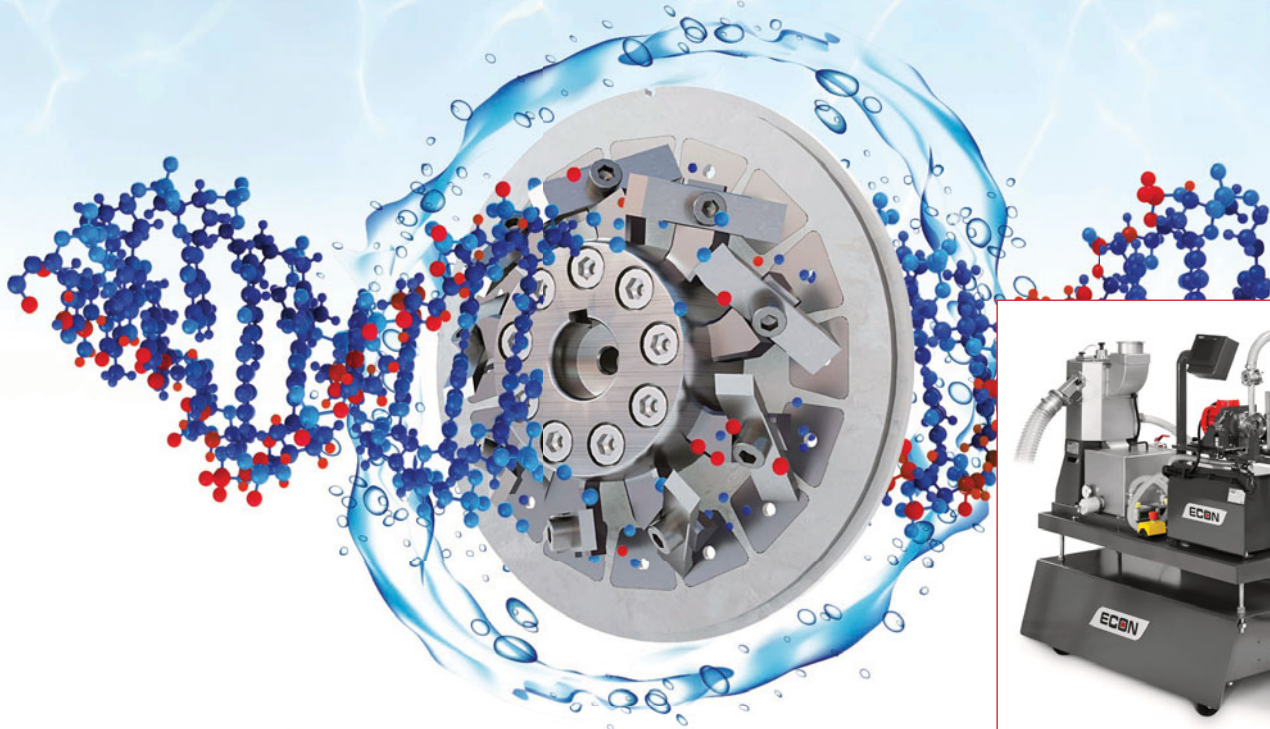

EUP 10 Advanced



Hall A6/Booth # A6-6107
October 12 - 16, 2021
Friedrichshafen, DE

www.econ.eu



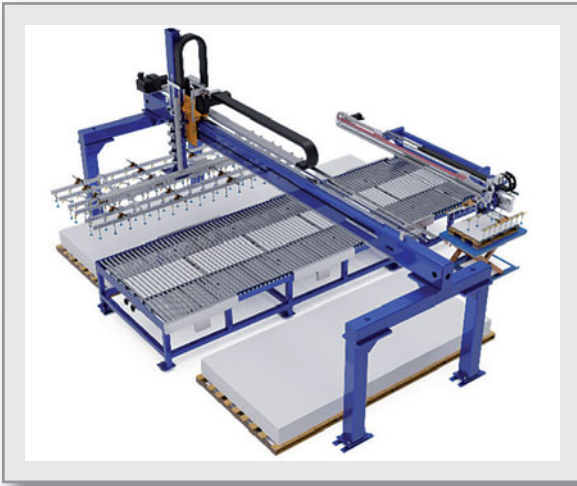
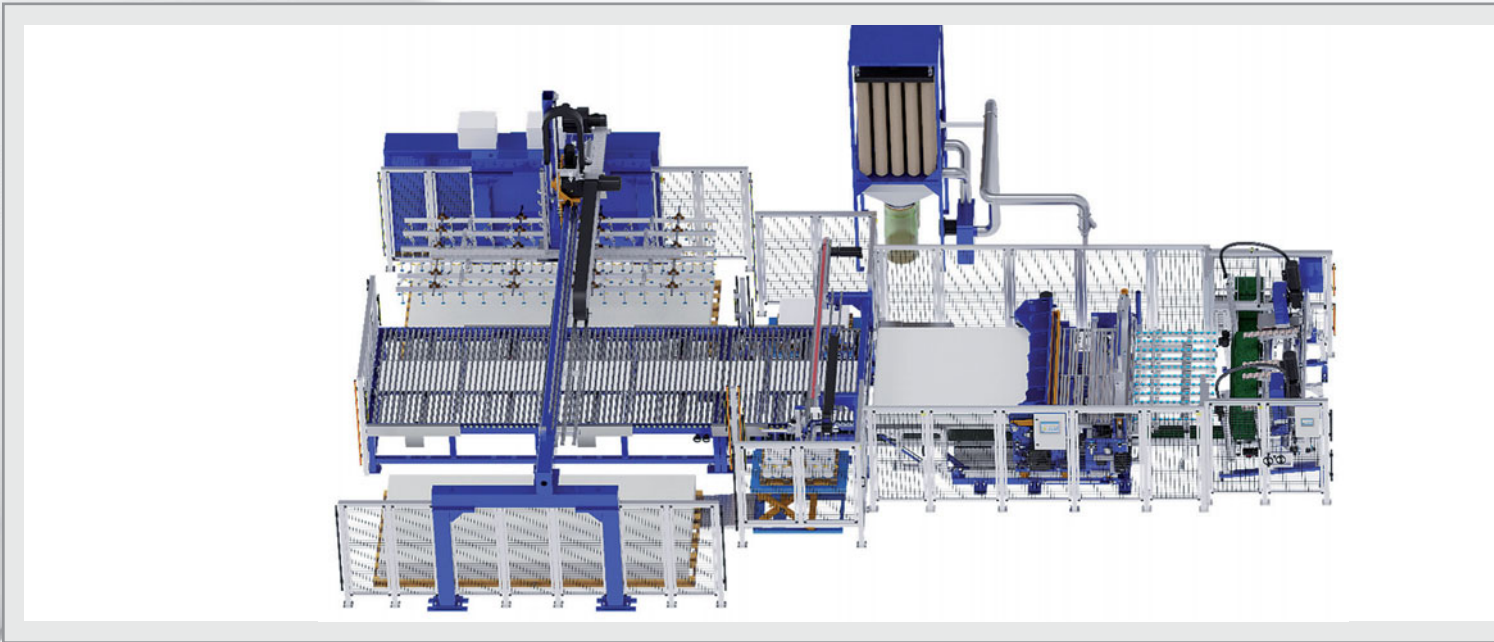

Plate Stacking Machine

for automatic depositing of your production plates on transport pallets or trolleys.

Optional available with:

- Additional stacking places
- Spreading device of sheets side by side
- Separation of consecutive panels for simultaneous stacking



Cross Cutting Combination

enables optional sawing or cutting in one machine.

Optional available with:

- Hydraulic driven scissor
- Electric driven scissor
- Cross Cut Mill instead of saw
- Cutting angle adjustment



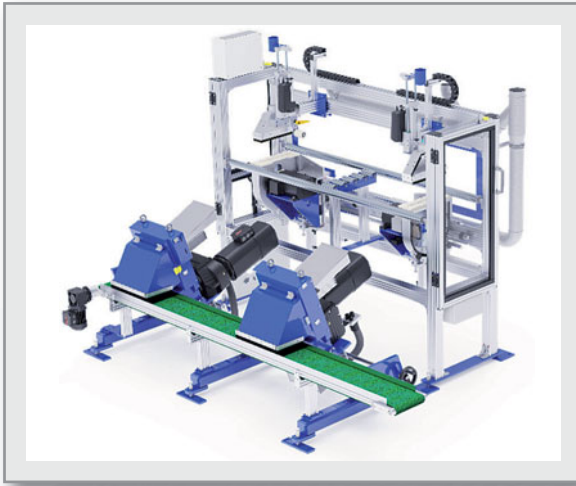

Edge Trimming Saw & Trim Strip Chopper

an unbeatable team for longitudinal cutting of your panel and direct shredding of the resulting return material.

The machines are also offered individually with many options.

As a specialist in the field of special machine construction, we always find a solution!



Pull Off Roller

provides precise regulation and compliance of roller speed and roller force.

Optional available with:

- Automatic material run control
- Selection of roller coatings
- Multiple Pull Off Roller version

Calender

for continuous dimensional accuracy and surface quality.

Key data:

- Throughput capacity depending on material 400 - 1300 kg/h
- Line speed 0,5 - 70 m/min
- Line pressure per roller: 100-1300 N/cm



**STEIN Maschinenbau
GmbH & Co. KG**

Wartbachstrasse 9
66999 Hinterweidenthal/Germany
Tel. (+49) (0)63 96-9215-0
Fax (+49) (0)63 96-9215-25
stein@stein-maschinenbau.de
www.stein-maschinenbau.de

Firms in this issue	6	Pipe Extrusion	
Imprint	7	Oriented PVC Pipes and Fittings within Circular Economy, Eco-Design as Main Drive	28
Industry News	8	Corrugated Pipe Extrusion	
Calendar	8	conEX NG Proves ist Quality in Corrugated Pipe Extrusion	31
Interpack 2023	8	Profile Extrusion	
White Paper: Use of Recyclates in Plastics Processing	9	„Growing Range of Large Format Profiles“	
The End of H1 with Increase of Shipments and Wages Marked	9	Large investment programme implemented	32
Recycled PET in a Closed Recycling Loop	10	Film Extrusion	
wire South America and TUBOTECH will not take place until 2022	10	Mono-Material Films – Solutions for a Circular Economy	34
Resole Capacity Expansion Plan in the U.S. and India Announced	11	Packaging Film	
Company in India Founded	12	New Recyclable Blister Film Launched	37
„SME Innovation Award“ received	12	Film Extrusion	
Study on the Global Market for Bioplastics	13	New Five-Layer Extrusion Line Started Up	38
New Management Team	14	Sheet Extrusion, Circular Economy	
Virtual Showroom – Leak Testing and CCIT Solutions for the Pharmaceutical Industry	14	Heat Resistant and Fully Recyclable – White rPET100 Packaging for Diary, Hot Drinks and Teady Meals	39
New High Performance Melt Filters	15	Fakuma 2021	
Minority Stake Acquired	16	Plastics Recycling Solutions	42
Plastic Additives’ Offerings with a High Sustainability Value	16	Free Live Material Tests with the PURITY CONCEPT V	43
New Screen Changer Enables Sustainable Use of Recyclate	17	Innovative MRSjump Extruder with High Decontamination Performance and a Viscosity Boost in One Single Extrusion Step	44
Capability to Provide PVC Compounds to Automotive OEMs and Tier 1 Suppliers in Japan Strengthened	18	Pump & Filtration Systems, Pelletizing & Pulverizing Systems, Recycling Systems and Digital Solutions	46
New Mixing Innovation	18	Focus on Circular Economy	47
„The Bullet™“ Extrusion Head	19	Extruder Manufacturer shows ist Versatility	48
Compact with New Cooling Option	20	Sustainability Geared Colour and Functional Masterbatch Solutions	49
Cooperation with Research Institutes of Sweden	20	Spotlight on High Quality Output and Reliability, New PET Hot-Wasch System and Micromat Premium Shredder	50
Size Reduction Technology Solves the Resource Dilemma	20	Digital Control Now Available for Entire Granulator Range	52
Sustainable Polyamide	22	Shaping a Sustainable Future	54
E-LOOP Products with Recycled Content	22	UHMWPE for Injection Moulding, Extrusion and 3D Printing	56
PURITY SCANNER ADVANCED to ensure the Highest Purity of XLPE Pellets used in China	22	New Halogen-Free Flame-Retardant Polyamide	57
Processing		„The future is sustainable“	58
We PET the Future	24		
Measuring Systems for Round Products			
Compact Two-in-One System for Round Product Inspection – AllRounDia DualVision	27		

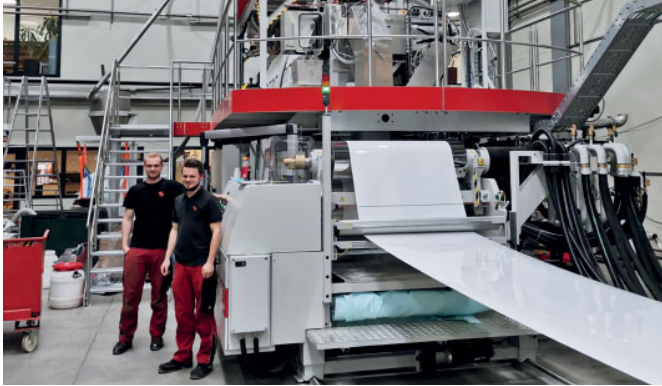

39 Starlinger viscotec, a division of the Austrian machinery supplier Starlinger & Co GmbH, has developed a new material to make packaging for dairy and hot-fill products fully recyclable



The Pixargus AllRoundDia DualVision inspection system for round products is the first of its kind able to perform surface inspection and dimension measurement simultaneously by just one common sensor head **27**

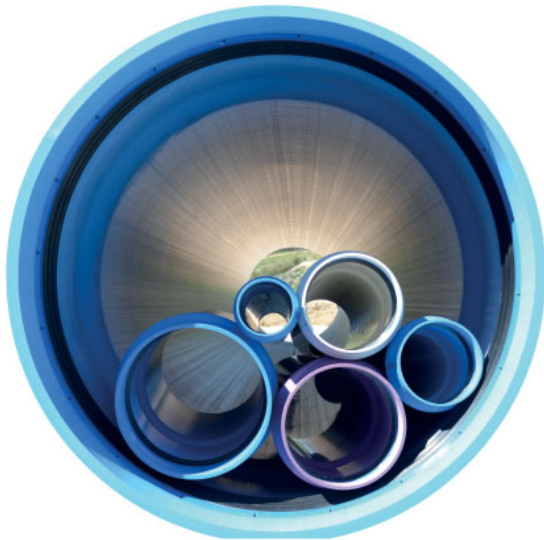

Molecor, as a company, and its fittings and pipes, as products, are aligned with the UN Sustainable Development Goals, with the aim of achieving a sustainable future for all **28**



52 Fakuma 2021 in Friedrichshafen will be Hellweg's opportunity to highlight that its entire range of granulators is now equipped with the digital Smart Control System, which was premiered at K 2019

Brückner Maschinenbau has developed mono-material packaging solutions to close the life cycle of plastic packaging as requested by brand owners and legislations **34**

SIKORA will present innovative measuring and control technologies for the tube, hose and pipe industry as well as online and offline systems for the inspection, sorting and analysis of plastic pellets at this years Fakuma **43**



Index of Advertisers, companies and fairs referred in this issue

Asahi Kasei	57	Müller, W.	17
BASF	16	Nanjing	41
battenfeld-cincinnati	31	NGA	12
Baumüller	20	NGR	21
Borealis	16	Nishinihon Shoko	18
Brückner	34	Nordmann	58
Ceresana	13	OCS	37
Dinnissen	18	Orion	20
DOMO	22	Pallmann	20
DREYPLAS	56	PET-MAN	10
Econ	Outside Cover, 24	Pfeiffer Vacuum	14
Elix	22	Pixargus	27, 29
EREMA	13	Plast EXPO UA 2022	23
Erge	17	RKW	38
Ettlinger	15	R&P POLYPLASTIC	9
Fakuma 2021	40	Schall, P.E.	40
FEDDEM	48	Sesotec	9
Feddersen	54	Siempelkamp	20
FRÄNKISCHE Rohrwerke	31	SI Group	11
Gneuss	44	SIKORA	12, 15, 22, 43
Greiner Packaging	10	SML	35
Guill	19	SLS	32
Hellweg	52	Smart-Extrusion	45, 53
Herbold Meckesheim	42	Starlinger viscotec	10
interpack 2023	8	Stein Maschinenbau	Inside Front Cover+3
ISRA VISION	14	Tecnomatic	Outside Back Cover
Klöckner Pentaplast	37	Teknor Apex	18
KRÜSS	39	Tosaf	49
Laboratory & Quality Control	Inside Back Cover	TUBOTECH	10
Lindner	50	VM Verlag	51
Maag	46	WEIMA	47
Messe Düsseldorf	8, 10	wire South America	10
MOLECOR	25, 28	Zambello	19
motan-colortronic	7	Zumbach	11



**Follow the news
in the world
of extrusion!**

Subscribe to digital magazines
and Smart Extrusion weekly newsletter

- **Just** submit your **e-mail address**.
- Digital magazines and news updates **free of charge**
- No spam. Your data is safe



www.extrusion-info.com/subscription

05/2021

VM VERLAG
Cologne, Germany

EXTRUSION INTERNATIONAL



The Extrusion International Magazine is published bimonthly by VM Verlag GmbH. P.O.Box 501812, D- 50879 Cologne, Germany

EDITORS

Bettina Jopp-Witt (Editor-in-chief)
Tel. +49 221 546 1539
redaktion@vm-verlag.com

Dmitry Kosuch
Tel. +7 996 730 0113
d.kosuch@vm-verlag.com

ADVERTISING SALES

Martina Lerner
Tel.+49 6226 971515
lerner-media@t-online.de

Bella Eidlin
Tel. +49 152 29907895
b.eidlin@vm-verlag.com

Olga Kirchner
Tel. +49 152 05626122
o.kirchner@vm-verlag.com

ADMINISTRATION

Alla Kravets
Tel. +49 2233 949 8793
a.kravets@vm-verlag.com

PRINTING

maincontor GmbH
Dr.-Gammert-Str. 13a, 63906 Erlenbach, Germany
T.: +49 937294810811
www.maincontor.de, info@frankhohmann.com

SALES REPRESENTATIVES

Quaini Pubblicita (Milano IT)
Tel. +39 02 39216180
info@quaini-pubblicita.it

China & Asia
octavia@ringier.com.hk, Tel. +852-9648-2561
maggieliu@ringiertrade.com, Tel. +86-13602785446

Tokyo PR Inc. (Japan)
Tel. +81 (3) 3273-2731
extrusion@tokyopr.co.jp

Reprints, Translation etc

No part of this publication may be reproduced, stored in a retrieval system, or transmitted, in any form or by any means, electronic, mechanical, photographic, recording or otherwise, without prior permission of the publisher.



www.smart-extrusion.com

motan® 
colortronic®

The smart way to dose pellets



Please visit us:
Hall B1,
Stand B1-1111



think materials management



GRAVICOLOR

With IntelliBlend and integrated conveying.

motan-colortronic gmbh - info@motan-colortronic.de
www.motan-colortronic.com



Fakuma

12. - 16. 10. 2021
Friedrichshafen, Germany
www.fakuma-messe.de

Central Asia Plast World

11. - 13. 10. 2021
Almaty, Kazakhstan
www.plastworld.kz

ARABPLAST 2021

15. - 18. 11. 2021
Dubai, UAE
www.k-globalgate.com/arabplast

Solids Dortmund

16. - 17. 02. 2022
Dortmund, Germany
www.solids-dortmund.de

PLASTINDIA

17. - 21. 02. 2022
New Delhi, India
www.k-globalgate.com/plastindia

ICE Europe

15. - 17. 03. 2022
Munich, Germany
www.ice-x.com/europe

CHINAPLAS 2022

25. - 28. 04. 2022
Shanghai, P.R. China
www.ChinaplasOnline.com

COLOMBIAPLAST

26. - 30. 09. 2022
Bogotá, Colombia
www.eng.colombiaplast.org

wire South America

TUBOTECH
25. - 27. 10. 2022
www.wire-south-america.com
www.tubotech-online.com

INDIA ESSEN WELDING & CUTTING 2021

23. - 25. 11. 2022
Bombay, India
www.india-essen-welding-cutting.com

interpack 2023

■ The registration window for the next interpack, which will be held from 4 to 10 May 2023 at the Düsseldorf trade fair centre, was set to open this year in autumn. Due to this year's cancellation (because to the pandemic), which first delayed the trade fair until spring 2021 and then cancelled it entirely, the companies that had already registered were given a one-off opportunity to rebook immediately for the next interpack, and this proposition was met with almost universal acceptance. Together with new registrations from other companies, the bookings received by mid-August 2021 had already filled 85% of the capacity.

"We're really excited by how enthusiastically our customers have taken up this offer. Again and again, we're hearing that you can hardly wait until interpack is back on again – as an in-person trade fair where you can meet face-to-face", reports Thomas Dohse, Project Director for interpack. According to feedback from the industry, the pandemic showed that digital alternative events were seen as a plus that provided added value, but meeting in person at a trade fair is irreplaceable in terms of generating new contacts and building trust, which is massively important. In addition, many companies demonstrate technically complex machinery and systems at interpack, and these need detailed explanation and are often appraised while in operation by potential customers at interpack. These customers also benefit from being able to make immediate comparisons between solutions from different suppliers.

interpack is living up to its promise as an internationally leading trade fair in the packaging industry and related processing industry in 2023 too, and is underscoring this with its new brand slogan "Simply Unique", which has recently been brought in and characterises its image. "The uniqueness of interpack is primarily characterised by the unparalleled diversity of the products and services that our exhibitors offer, but it is rounded out by our special themes that pick up on the trends for the coming years. In 2023, sustainability and all of its facets will be even more significant than it has been in years past, which means that we will be tackling this set of themes in cooperation with our partners. In addition to these impressive in-person offers, there will also be digital offers", states Thomas Dohse.

The details on the individual special themes and also on additional digital offers at interpack 2023 will be made public during the coming year.



► Messe Düsseldorf GmbH
www.interpack.de

White Paper: Use of Recyclates in Plastics Processing

■ From society to politics to industry – everyone acknowledges that a functioning circular economy is necessary to meet climate goals.

Everyone also agrees that the use of recyclates must be significantly increased. But there are a number of obstacles and problems along the way. For example, not enough recyclates are available in sufficient quantity and suitable quality. This is due to the fact that recycled plastics are very heterogeneous in composition (type of material, color, foreign bodies). In addition, the prices for recyclate are rising very fast. Innovative process technology is needed to improve profitability and reduce the risk involved in the use of recycled plastic materials.

In the new Sesotec White Paper “Using recycled materials in plastics processing” you can find out why there is increasing pressure on plastics processors to use more recyclate; the differences

between post-consumer and post-industrial recyclate; the problems plastics processors may face when using recyclate; how to future-proof your processes to effectively handle increasing volumes of recyclate.

The Sesotec white paper is available for free download:

www.sesotec.com/emea/en/resources/blog/white-paper-using-recycled-materials-in-plastics-processing

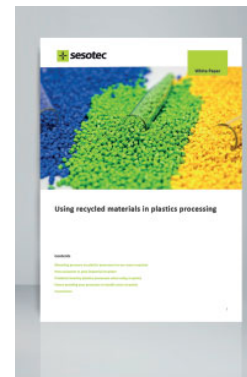

The new white paper from Sesotec (Image: Sesotec GmbH)

Sesotec GmbH
www.sesotec.com

The End of H1 with Increase of Shipments and Wages Marked

■ During the first 6 months of the year Russian compounder R&P POLYPLASTIC increased shipments both inside the country and abroad, introduced a number of important measures, successfully underwent audits of leading auto manufacturers and received high scores for financial stability and corporate social responsibility system.

Sales performance of Trade House “Polyplastic” improved by 13 % compared to the same period of last year, while international shipments increased respectively by 6.6 %. In 2021, the leading Russian compounder came into the Polish market. The first shipment took place in April, later a cooperation agreement with MOBI Sp. z o.o., one of the leading polymer distributors from this European country, was signed.

“We managed to overcome the crisis connected with rapid price appreciation for raw materials. Increase in the cost of polypropylene and PA6 was a real shock for consumers. We tried as best as we could to keep prices down. However, in the end we were forced to increase the prices due to the dynamics of raw materials prices”, noted Pavel Kruglov, Director General of Trade House “Polyplastic”.

During the first half of the year R&P POLYPLASTIC implemented a number of measures aimed at supporting its employees: a 20 to 30 % increase of meal remuneration, new system of proportional growth of extra payments for length of employment over one year. Average pay rise for blue-collar workers amounted to 20 %.

“The most important part of any production are people rather than equipment and technologies. Today we are witnessing a lack of skilled production specialists on the Russian

HR-market. Establishing appropriate working conditions allowing to attract best staff members is our top-priority. We are in the process of upgrading our corporate social system since the beginning of 2021”, says Aleksandr Pavlov, Director General of R&P POLYPLASTIC.

In H1 the company received audit results from Renault-Nissan-Mitsubishi Alliance, Magna International and Faurecia. The ASES audit resulted in the company’s rating improvement while audits of Magna International and Faurecia confirmed the existing sufficiently high ranking. Furthermore, R&P POLYPLASTIC underwent an audit of the corporate social responsibility system by a reputable international company EcoVadis and doubled its results of the year 2017. Financial stability of the company was confirmed by the highest triple-A rating by “Kontur.Expert”. “Beginning of the year 2021 was marked with a number of hardships for the polymer industry, however, professional tactical decisions allowed as to maintain financial stability and a constructive relationship with our partners while good audit results proved us right. In the year of its 30th anniversary, R&P POLYPLASTIC is demonstrating strong performance and does not intend to remain complacent. This year we are planning an expansion of production volumes by launching two new lines with a total capacity of 20 thousand tons”, summed up Andrey Menshov, Managing Partner of R&P POLYPLASTIC.

R&P POLYPLASTIC
www.polyplastic-compounds.ru/eng/

Recycled PET in a Closed Recycling Loop

■ It is a world premiere: school milk in Upper Austria is now packaged in 100 % sustainable cups made of recycled PET (rPET). The joint project of Austrian school milk producers and the three Upper Austrian companies PET-MAN, Greiner Packaging and Starlinger viscotec is revolutionizing the food packaging market and proves that a sustainable circular economy is possible.

Every day, around 36,000 children in Upper Austria are supplied with fresh school milk products. "To carry through the origin idea of the regional and sustainable product to the packaging, we thought about how to make it so that the cups are 100 % recyclable and reusable," explains Markus Neudorfer, Managing Partner of the sheet manufacturer PET-MAN. The solution is a white cup made from 100% rPET.

The benefits of this material are obvious: it is lightweight, unbreakable and plasticizer-free, making it ideal for school kids. However, rPET (recycled polyethylene terephthalate) is far more than conventional plastics. "The new rPET cups consist of 100 % recycled, unprinted rPET mono material and can be recycled over and over again into 100 % food-grade cups," says Alisa Schröer, responsible for Circular Economy projects at Greiner Packaging. Recycling the cups requires less energy than reprocessing reusable glass, for example, and produces less waste. The school milk farmers take the used cups back with their next school milk delivery. This results in over 30 % less CO₂ emissions compared to reusable glass bottles.

"The cups are collected, washed and shredded. The shredded material, known as flakes, are then cleaned and processed using viscotec technology. This rPET material will again be used to make cups for food packaging," explains Herbert Hofbauer from Starlinger viscotec. As a result, many tons of packaging waste are avoided every year.

The entire production and recycling loop of the school milk takes place in Upper Austria. The cows graze on local pastures and the fresh milk is bottled directly by the school milk farmers and delivered

The rPET cup revolution: the cups are recycled into new cups over and over again in a closed loop



After their use, the cups are returned for recycling

to the schools. "Thanks to the partnership with the three Upper Austrian companies PET-MAN, Greiner Packaging and Starlinger viscotec, we can now provide a sustainably packaged school milk to the kindergartens and schools produced exclusively in Upper Austria," states Johannes Strobl, farmer and chairman of the Upper Austrian school milk producers.

Children should be made aware of the sustainable use of nature as early as kindergarten and school age. By using the 100 % recycled rPET cups, they learn that plastic is not just plastic and makes it a big difference, whether packaging is simply disposed or can be recycled over and over again: the closed recycling loop of the valuable material makes recycled PET a material for the future.

It is interesting to know that recycled PET is currently the only post-consumer secondary plastic that is allowed to be used in food applications in the European Union. The school milk packaging made of rPET can therefore be recycled again and turned into food packaging, making it THE recyclable packaging for dairy products.

The visionary project has been nominated for the following awards: Green Packaging Star Award 2021 and TRIGOS 2021, Austrian award for responsible business, in the category „Exemplary project“.

► www.rPET-cup.com

PET-MAN GmbH
www.petman.at

Starlinger viscotec
www.viscotec.at

Greiner Packaging
www.greiner-gpi.com

wire South America and TUBOTECH will not take place until 2022

■ Brazil is still suffering badly from the consequences of the COVID 19 pandemic – there is no thought of opening prospects for trade fairs and other major events. Therefore, the organizers of wire South America, Cipa Fiera Milano and Messe Düsseldorf, have decided to cancel the trade show for 2021 and postpone it to October 25-27, 2022.

The concurrent TUBOTECH, International Trade Fair for Tubes, Valves, Pumps, Fittings and Components, will also be postponed to this new date. Originally, wire South America was to be held October 5-7, 2021, at the Sao Paulo Expo Exhibition & Convention Center.

► www.wire-south-america.com
www.tubotech-online.com

Announces Resole Capacity Expansion Plan in the U.S. and India Announced

■ SI Group, a leading performance additives company, announced plans to increase resole production capacities at their facilities in Rotterdam Junction, New York, and Lote, India. The goal of this capacity expansion of more than 25% is to propel the sites to become two of the world's leading resole production and technology locations.

The debottlenecking investments are slated for completion later this year. The expanded capacity will help address an increasing global demand for resole resins used in the automotive and adhesive value chain.

"These investments are a result of our focused efforts on growth and responding to our customers' needs," said Robert Kaiser, Vice President, Rubber & Adhesives Solutions at SI Group. "They will help provide superior solutions at the

highest reliability of supply for our global customer base." SI Group has a long history of manufacturing resole resins used to enhance the durability and heat properties of rubber products. In adhesives systems, resole resins improve mechanical and heat resistance while providing higher initial adhesion, open time and weatherability.

In addition to resole resins, the company also has a robust rubber and adhesive portfolio of novolac tackifiers, anti-degradants, bonding, and reinforcing resins manufactured globally. This expansion follows earlier announcements by SI Group to expand resin capacity in Lote, India; Bethune, France; and Nanjing, China.

■ SI Group
siigroup.com

Precision Wall Thickness Measurement

Zumbach
SWISS PRIME MEASURING SINCE 1957

RAYEX S XT

- Easy and quick set up for new products
- Fast eccentricity and diameter measurement
- Added longevity due to high-quality xray source



Family owned since 1957, Zumbach is a global leader in the industry. Driven by innovation and experience. We are here for you and ready to build the future together.

www.zumbach.com • sales@zumbach.ch

Company in India Founded

■ “India is the fastest growing market for the polymer industry, especially for the topics masterbatch, compounding and blown and cast film production. It is a fact that local plastic processing companies upgrade their production infrastructures with technologies, which correspond to global standards”, explain Dr. Friedrich Kastner and Corné Verstraten, the majority shareholders of the NGA Group.

The NGA Group recognized the great market potential as well as the need of the Indian industry of latest leading-edge technology at affordable prices – and has founded NGA Plastic Technology Private Limited. The Austrian NGA GmbH holds 70 % of the Indian company, 30 % are held by Techscience Service Pvt Ltd, an Indian company, which, as distributor, has been working together with COLLIN Lab & Pilot Solutions GmbH for more than 30 years.



*Rajnish Soodd, Country Manager
NGA Plastic Technology Private
Limited (© NGA)*

Main target of the new company is to provide growing markets with easy-to-handle test and R&D lines in laboratory scale – based on the well-trying COLLIN technology, manufactured in India under the brand name “COLLIN Asia”.

The first series of machines will be introduced under the sub-brand EASY LINE. EASY LINE table-top machines are designed for the processing of polymers, for apprenticeship, research and development and include presses, extruders, compounders, blown as well as flat film lines, roll mills and pressure filter tests.

In order to perfectly exhaust this potential, NGA decided to take the industry insider Rajnish Soodd as Country Manager on board. „From our branch office, besides the Indian market, we can also serve South East Asia and Africa perfectly”, explains Rajnish Soodd, Country Manager NGA Plastic Technology Private Limited.

„The multifaceted cooperation of Rajnish Soodd with manufacturers of investment goods for the polymer industry for more than two decades and his closeness to different market segments, like compounding, masterbatch or petrochemical industry, will help him to understand the dynamic requirements of the industry. And with his expertise, he will effectively position the range of products of COLLIN Asia in the target market segments”, says Corné Verstraten.

The foundation of the Indian branch is a perfect mixture of German and Indian know how in mechanical engineering in order to offer affordable technology. With this successful, important step, the NGA Group expands its geographical presence.

■ NGA Plastic Technology PVT LTD
www.nga-solutions.in

“SME Innovation Award” received

■ SIKORA is one of the most innovative small and medium-sized enterprises (SME) in Germany 2021/2022, according to a survey conducted by the independent German Association for Consumer Studies (DtGV).

This year, for the first time, the German Association for Consumer Studies (Deutsche Gesellschaft für Verbraucherstudien, DtGV) is presenting the “SME Innovation Award 2021/2022” to small and medium-sized companies from Germany that demonstrate particularly high innovation potential in their segment and/or state. For the selection, the number of all patent applications of German SMEs in 2020 was first determined based on the Corporate Patent Classification (CPC) system. The basic parameter patent number was finally rounded off by the qualitative moment of the citation frequency and condensed into a score value. SIKORA receives the award, as the company achieved a score value in the CPC main class “instruments”, which is among the top 10 % of all examined SMEs. In the parallel federal state ranking SIKORA is furthermore listed among the top 3 companies from Bremen.

*SIKORA receives
the SME Innovation
Award 2021/22
for its innovative
strength*



Every year, SIKORA invests more than 10 percent of its turnover in the research and development of new measuring and control technology as well as inspection, analysis and sorting systems for quality assurance during the production of wires and cables, hoses, tubes, pipes and sheets, glass fibers or plastics. With more than 300 employees at its headquarters in Bremen, Germany, and in its 14 international subsidiaries, the company offers innovative solutions and customized customer service worldwide.

■ SIKORA AG
www.sikora.net

Study on the Global Market for Bioplastics

■ Compostable disposable tableware, mulch films that rot on the field or fishing nets that simply disintegrate over time: are bioplastics the solution to waste problems? High hopes are being placed in plastics made from sugar cane, potato starch or other renewable raw materials. Biopolymers are conquering an increasing number of application areas and achieving significantly higher growth rates than conventional standard plastics. Ceresana has analyzed the dynamically growing global market for “green” polymers for the sixth time: Analysts expect revenues from bioplastics to rise to approx. USD 8.1 billion by 2030.

Plastics and packaging are central product groups for the “Circular Economy Action Plan” published by the EU Commission in spring 2020 as part of the “Green Deal”. In order to overcome the throwaway society and reduce the amount of waste, the EU Commission is planning, among other things, a plastic tax, restrictions on microplastics and the promotion of plastic recycling. By the end of 2021, new “framework legislation for bio-based, biodegradable and compostable plastics” should clearly regulate and define what is meant by these terms and

how bioplastics should be disposed of.

Chapter 1 of the study provides a comprehensive presentation and analysis of the global bioplastics market – including forecasts up to 2030.

In Chapter 2, the 8 most important sales countries are considered individually: Germany, France, the United Kingdom, Italy, Spain, the USA, China and Japan.

Chapter 3 provides useful company profiles covering the most important bioplastics manufacturers, clearly arranged by contact details, revenues, profit, product range, production sites and brief profile. Detailed profiles are provided by 91 manufacturers.

■ Ceresana
www.ceresana.com/en/market-studies/plastics/bioplastics/

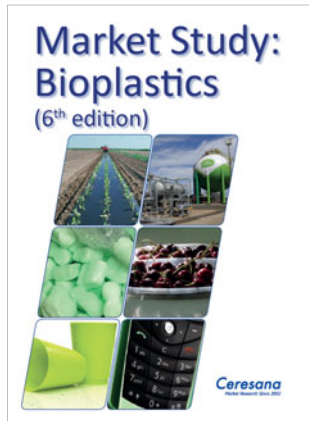

WE DRIVE THE CIRCULAR ECONOMY.



VISIT OUR virtual showroom **ShowHello!**

Whether it is inhouse, post-consumer or bottle recycling: you can only close loops in a precise and profitable way if machines are perfectly tuned for the respective application. Count on the number 1 technology from EREMA when doing so: over 6000 of our machines and systems produce around 14.5 million tonnes of high-quality pellets like this every year – in a highly efficient and energy-saving way.



CHOOSE THE NUMBER ONE.

New Management Team

■ More than three decades ago, ISRA VISION was founded as a spin-off of the Technical University of Darmstadt and subsequently developed into a leading global machine vision technology company. End of June 2021, the founder and CEO of ISRA VISION, Enis Ersü, will retire from his operational professional life. In the course of his succession planning, ISRA has entered into a strategic partnership with the Swedish industry group Atlas Copco and forms the nucleus of the new Machine Vision Solutions division. With a new, powerful management team, the course is now being set for further successful business development.

The new three-member management team consists of the two ISRA VISION Executive Board members Hans Jürgen Christ and Dr. Johannes Giet and the new speaker of the ISRA VISION Executive Board Tomas Lundin. Tomas Lundin worked for the Atlas Copco Group for over 20 years in various management positions. With his many years of market and management experience, he brings with him the best qualifications for the future growth tasks at ISRA VISION.

Hans Jürgen Christ has been with ISRA VISION for 25 years. Already in the first years, he took over the important task of sales management and, as CSO, is one of the managers who have significantly contributed to the growth of ISRA VISION.

Dr. Johannes Giet came to ISRA in 2001 via the acquisition of Rheinmetall Machine Vision, where he himself was the transaction manager. Subsequently, he took over the management of the development of ISRA VISION worldwide.



The new ISRA VISION management team, from right: Hans Jürgen Christ, Tomas Lundin (speaker), Dr. Johannes Giet takes over from the retiring CEO and founder Enis Ersü (left)

With Atlas Copco, ISRA can fall back on a large, worldwide competence network with the goal of continuing the previous success story. As a separate "Machine Vision Solutions" division in Atlas Copco's Industrial Technique business area, ISRA will continue to operate from its headquarters in Darmstadt. For this purpose, the company is building a new headquarters in the north of Darmstadt. The move-in is scheduled for the end of 2022.

ISRA VISION AG
www.isravision.com

Virtual Showroom –

Leak Testing and CCIT Solutions for the Pharmaceutical Industry

■ WIn its virtual showroom, Pfeiffer Vacuum presents a variety of different leak testing methods for pharmaceutical packaging (container closure integrity testing or CCIT). Visi-

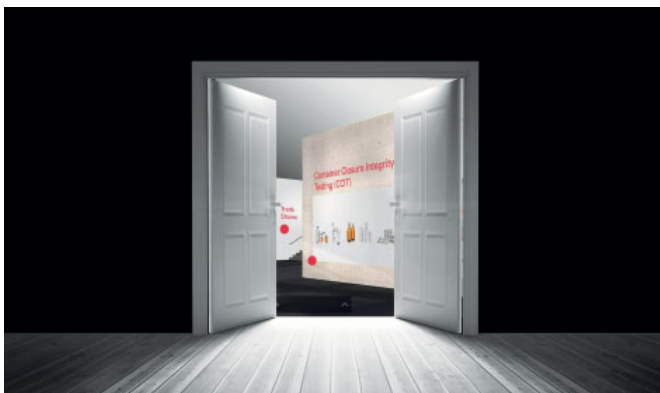

tors to the site will find information about the challenges of leak testing IV bags, syringes, blister packs, plastic bottles, vials and other non-porous containers. At the virtual trade show booth, visitors will learn about Pfeiffer Vacuum's portfolio of leak detectors. Informative videos explain the different technologies used – helium mass spectrometry, optical emission spectroscopy and mass extraction.

As well as presenting the different leak testing methods for pharmaceutical packaging, the showroom also provides more information on individual feasibility studies. The experts from Pfeiffer Vacuum use studies like these to visualize the particular packaging and test the possible use of CCIT. Pfeiffer Vacuum uses the three CCIT technologies to obtain a realizable detection limit and cycle time for the packaging.

Pfeiffer Vacuum GmbH
www.pfeiffer-vacuum.com

New High Performance Melt Filters

■ ETTLINGER, a member of the MAAG Group and a leading manufacturer of continuously operating high performance melt filters, has unveiled a new generation of tried-and-tested ECO products for use in PET recycling. Their new features take into account the need for systems with a higher product throughput and are initially available in sizes suitable for medium-sized recycling lines. The new performance enhanced ECO 350 replaces the former ECO 250, while the new ECO 500, capable of achieving capacities of up to 4,000 kg/h, replaces the former ECO 250 Twin. The ECO 200 completes this range.

Ettlinger's melt filter technology is based on the principle of self-cleaning with a continuous flow of melt from the outside to the inside of a rotating, perforated drum. A scraper removes the contaminants that are held back on the surface and feeds them to the discharge system. Just like the ERF filters, which are designed for higher contamination, the new ECO filters also have a modular structure, thereby providing a wide range of options for adjusting the filter properties to the respective task. A new innovative system facilitates an even higher concentration of contaminated discharge, which, in turn, further decreases the already typically low loss of PET melt associated with Ettlinger's melt filters. Better access to the scraper system reduces the amount of time needed by the operator for maintenance and replacement tasks. The discharge now exits via the front side of the ECO filters, which is generally easier for the user to access.

The ECO melt filters are designed to process very low viscosity polymer feedstock (mainly PET and PA) and to facilitate the efficient filtration of contaminants such as paper, wood, aluminium, silicone, etc. Moreover, the closed discharge system prevents the occurrence of black specks. For this reason, the classic application for ECO melt filters is extrusion systems where

PET bottle flake is converted into food packaging films, packaging tape and fibres, as well as PET repelletising and compounding processes. ECO melt filters are suitable for single-screw or twin-screw extrusion lines, irrespective of the pelletising system or other downstream units.

Ettlinger's new ECO 500 high performance melt filter achieves throughputs of up to 4,000 kg/h (© Ettlinger)



▶ Ettlinger Kunststoffmaschinen GmbH
www.maag.com



Live: free material tests with the **PURITY CONCEPT V** at our booth A6-6110
Just bring your pellet samples!



The light table. Automated.

The **PURITY CONCEPT V** combines the advantages of an optical light table with automatic inspection, visualization and evaluation of contamination.

- Sample inspection and analysis of plastic material, flakes and testing plates
- Reproducible, automated inspection in 30 seconds
- Detection of tiny contamination and color deviations
- Clear assignment, visualization and analysis of the individual contaminant



www.sikora.net/purityconcept





VIDEO

Minority Stake Acquired

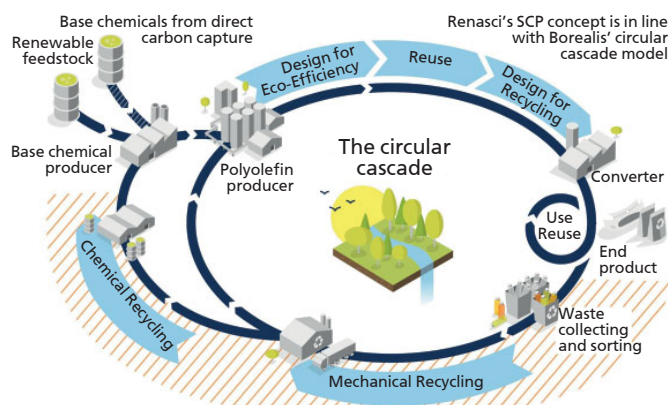

Infographic – Borealis' circular cascade model (© Borealis)

■ Borealis announces that it has entered into a multi-dimensional partnership with Renasci N.V., a provider of innovative recycling solutions and creator of the novel Smart Chain Processing (SCP) concept. The partnership is another key enabler for Borealis to realise its ambitions to bring circular base chemicals and polyolefins to market, and to deliver on its promise to bring 350 kilotons of recycled polyolefins into circulation by 2025.

The SCP concept developed by Renasci is a proprietary method of maximising material recovery in order to achieve zero waste. It is unique because it enables the processing of multiple waste streams using different recycling technologies – all under one roof. At the newly-built Renasci SCP facility in Oostende, Belgium, mixed waste – plastics, metals, and biomass – is automatically selected and sorted multiple times.

After sorting, plastic waste is first mechanically recycled, and then in a second step any remaining material is chemically recycled into circular pyrolysis oil and lighter product fractions, which are used to fuel the process.

Other types of sorted waste such as metals and organic refuse are further processed using other technologies. In the end, only

5% of the original waste remains, and even this residual material is not landfilled, but used as filler in construction materials. Because of this extremely efficient way of processing, the overall CO₂ footprint of these waste streams is greatly reduced – yet another advantage of the circular SCP concept.

Borealis circular cascade model sits at the heart of its ambition to achieve a truly circular economy, by combining carefully chosen technologies in a complementary and cascading way to achieve full circularity. In this way, Borealis aims to give plastic products multiple lifetimes in the most sustainable way possible. Starting with optimising product design, first for eco-efficiency, then for re-use and finally for recycling. Once a product has reached its end of life, we must close the plastics loop: first with mechanical recycling to make products with the highest possible value, quality and lowest carbon footprint; then utilising chemical recycling, as a complement to mechanical recycling, to further valorise residual streams which would otherwise go to incineration, or even worse to landfills. The valorised material from mechanical and chemical recycling is then processed with Borealis Borcycle™ recycling technology consisting of Borcycle M for mechanical recycling and Borcycle C for chemical recycling, providing high quality solutions for more sophisticated applications, such as food packaging and healthcare.

The SCP concept is aligned to Borealis' ambition to close the loop on plastic waste as encapsulated in its circular cascade model.

Having acquired a 10% minority stake in the company, Borealis will collaborate closely with Renasci to evolve and scale up the unique SCP technology. This includes the development of future facilities which would source their feedstock entirely from household waste. The two companies also plan to identify and act on other promising investment opportunities in the circular economy sphere. In addition to the recently announced agreement to source the projected 20 kt circular pyrolysis oil annually, Borealis is also planning to purchase mechanically recycled material from Renasci's Oostende facility.

■ Borealis AG
www.borealisgroup.com

Plastic Additives' Offerings with a High Sustainability Value

■ BASF has focused the sustainable solutions of its plastic additives' portfolio under the new global brand VALERAS™. VALERAS bundles the company's longtime experience, innovative solutions, and regulatory support with the aim to increase the sustainability of plastics along the entire polymer value chain. Later this year, the portfolio will expand to include the company's additive packages for mechanically recycled plastics and their applications.

"The trend towards sustainability has been accelerating, driven by consumer demand and more stringent legislation. Our customers are facing increasing pressure regarding sustainable innovations and challenges of plastics recyclability," says Dr. Thomas Kloster, President, Performance Chemicals, BASF.

"With VALERAS, we create new value for plastics by supporting our customers on their sustainability journey with novel solutions and services. VALERAS shows our broader ambition: to establish a platform that covers all our additive solutions that contribute to the sustainability goals of our customers."

VALERAS includes BASF's existing plastic additives that bring a significant sustainability value to plastic applications by improving durability, saving energy, reducing emissions, and promoting biodiversity.

■ BASF Plastic Additives
www.plasticadditives.basf.com

New Screen Changer Enables Sustainable Use of Recyclate



The screen changer is safe to operate manually. To simplify the process, for example, a cordless screwdriver can be used (Photo: W. MÜLLER)

■ The blow molding specialist W. MÜLLER has developed a new generation of screen changers for its extruders in extrusion blow molding. It is designed to be particularly space-saving. It is also suitable for installation in vertically oriented extruders, can easily be retrofitted and operated safely. When using PCR, a screen changer is recommended.

Filtering the melt is an essential element of controlled extrusion – especially when using Post-Consumer-Recyclates (PCR). The filtering screen consists of a fixed perforated carrier plate, which is covered by several interchangeable grids with different mesh sizes. If the differential pressure on this grid exceeds a certain value, the screen must be changed.

Johannes Schwarz, sales manager at W. MÜLLER explains: “The screen changer ensures, that impurities are kept away from the extrusion head. In addition to the use of PCR, which can be contaminated with other plastics or particles, it is, for example, abrasion from the mill, degraded plastic material or today often sections of cable ties, which are to be absorbed by the screen changer from the material flow. Such impurities interfere with the process and may lead to interruptions in production. It would be even more problematic if a leaking container would be produced and ended up in the filling station.”

Managing Director Christian Müller specifies: “Of course, we are also talking about the usage of recyclates. In the processing of recycled material, in particular PCR materials, the risk of contamination increases, which does not enter the production process from the outside but from the used material itself. These can be, for example, snippets of aluminum lids

or sleeves of bottles. In operation, the screen is slowly getting clogged and must be changed regularly. How often, depends on the quality of the processed material. W. MÜLLER has designed its own system for this change.”

The screen changer can be retrofitted and does not require any special safety precautions, as it does not have its own drive. It can be operated manually or e.g., by using a cordless screwdriver without effort.

For PCR processing, W. MÜLLER offers the ReCo3system for its extrusion units, consisting of three independent extruders. The PCR layer is enclosed in the middle by two layers of virgin material. The extruders are mounted vertically for this process.

Jens Schlueter, President of W. MÜLLER USA, Inc. explains: “We are also receiving more and more inquiries from North, South and Central America about systems for safe recyclate-processing. I expect a further significant increase here, also because of the changing raw material situation. The production of gasoline and diesel is declining. Accordingly, less ethylene and propylene is present for polymerization. This will further drive the demand for alternative materials.”

W. MÜLLER GmbH
www.mueller-ebm.de



ERGE Elektrowärmetechnik - Franz Messer GmbH
 91220 Schnaittach - Hersbrucker Straße 29-31
 Tel. +49/9153/921-0 Fax +49/9153/921-117
www.erge-elektrowaermetechnik.de
 mail: verkauf@erge-elektrowaermetechnik.de

HEIZEN

HEATING



TROCKNEN

DRYING

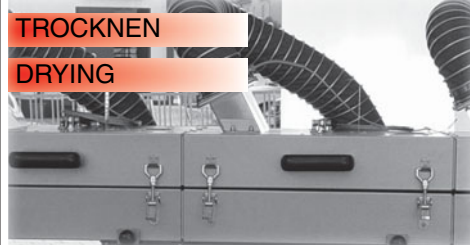

REGELN

CONTROLLING

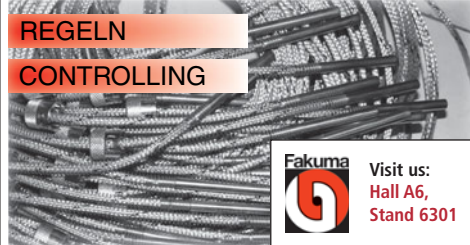



Visit us:
Hall A6,
Stand 6301

ELEKTROWÄRME TECHNIK FRANZ MESSER GMBH

Capability to Provide PVC Compounds to Automotive OEMs and Tier 1 Suppliers in Japan Strengthened

■ Teknor Apex Company has established a warehouse and distribution facility in Kyoto for its PVC automotive compounds and has appointed a sales agent responsible for serving auto-industry companies in Japan.

The new sales agent is Nishinohon Shoko Co., Ltd., an Osaka-based company specializing in supplying the automotive industry. Kozo Okamoto is president and CEO. The manager of automotive accounts will be Hirofumi Okamoto, and Kazuo Yamada will provide technical support.

“We already supply PVC compounds to Japanese OEMs in other regions of the world, and now we have strengthened our capability to serve OEMs and Tier 1 suppliers in Japan directly,” said Steve McCormack, automotive industry manager for the Vinyl Division. “This is critical for meeting the just-in-time requirements of our customers in Japan.”

Teknor Apex manufactures Apex® flexible PVC and Flexalloy® PVC elastomers for exterior and interior components, sealing systems, mechanical cables, and under-hood applications. These compounds have been specified by automotive OEMs worldwide.



*Exterior Automotive Profiles with Class A Finish,
Produced from Apex® Flexible PVC*

■ G.Nishinohon Shoko Co., Ltd
www.e-nishinohon.com/e/

Teknor Apex Company
www.teknorapex.com

New Mixing Innovation

■ Dinnissen Process Technology introduces the new Pegasus® R&D Mixer. This innovation in mixing technology was born out of a very specific request from a customer of Dinnissen. This producer asked for a compact mixer for testing a very specific chemical process. For this purpose, Dinnissen designed and built a special Pegasus® R&D Mixer: a very small mixer that allows producers to quickly and efficiently experiment and test different product compositions using complex processing techniques. What producers can use R&D mixers for:

- Testing many ways to improve products and processes.
- Adding different ingredients and mixing small batches within a relatively short time.
- Testing recipes and experimenting to find the best possible product composition.
- Creating new products and innovations in a cost-effective way.

To discover new ways to create renewable energy sources, a company in the chemical sector approached Dinnissen to come up with a solution to test their ideas on renewable energy. Their very specific chemical process requires that a batch is mixed continuously for 24 hours with exactly 1 gram of additives, while temperature and humidity are controlled.

For this project, Dinnissen’s engineers developed a compact Pegasus® R&D mixer in which all raw materials can be kept in motion for long periods of time and can be tested in small batches. Using the proven Pegasus® mixing technology as a basis, Dinnissen designed just the right system for this testing procedure. The first results of these tests show enormous potential. This R&D mixing installation has the potential to grow into large-scale chemical processing lines that will have a positive impact on the global production of renewable energy.



■ Dinnissen Process Technology
www.dinnissen.eu/news/
[/dinnissen-presents-a-new-pegasus-r-d-mixer](http://dinnissen-presents-a-new-pegasus-r-d-mixer)

„The Bullet™“ Extrusion Head

■ Guill Tool introduced The Bullet® in 2015, a new extrusion head with fixed center design, multi-port spiral flow design and gum space adjustment, plus the added feature of no fastening hardware, so cleaning and restart are easier and faster than any conventional head on the market currently, according to company sources. The company announces the next generation of this unique and patented tool, The Bullet II.

The Bullet II allows quick tooling changes, as the tips remove from the back and the die removes from the front of the unit. The absence of fastening hardware eliminates leaking, as does the taper body and deflector design pioneered by Guill. Additionally, the new patent pending CAM LOCK® deflector retaining system offers these additional benefits to extruders and machine builders:

- It only takes ½ turn of the Cam Lock® to remove and install the Deflector and Tip
- No fastening hardware required
- Fast tool changes, threaded retaining ring for the die and threaded tip retainer
- Dies are removed from the front and tips from the rear
- Tooling retainers also provide gum space adjustment
- Hassle free air / vacuum connections
- Simplified cleaning
- Reduces downtime and lowers operating costs

High- and low-volume applications are suitable for this head and are accommodated with the simple, easy changing of just one component. A family of crosshead designs is available and users can specify the “caliber”, that is, the max. die ID.

A vacuum chamber and kit for assembly and disassembly are included with the unit. Optional keyed tooling capability offers machine designers and end users quick orientation, so the overall unit design enables faster disassembly, proper cleaning and restart, allowing the line to become more profitable, more quickly.

For a video demonstrating this new design, please visit: www.youtube.com/watch?v=MpEdmCRtaq

The Bullet, showing the absence of hardware, i.e. nuts and bolts, so disassembly, cleaning and restart are made easier



■ Guill Tool & Engineering Co., Inc.
www.guill.co

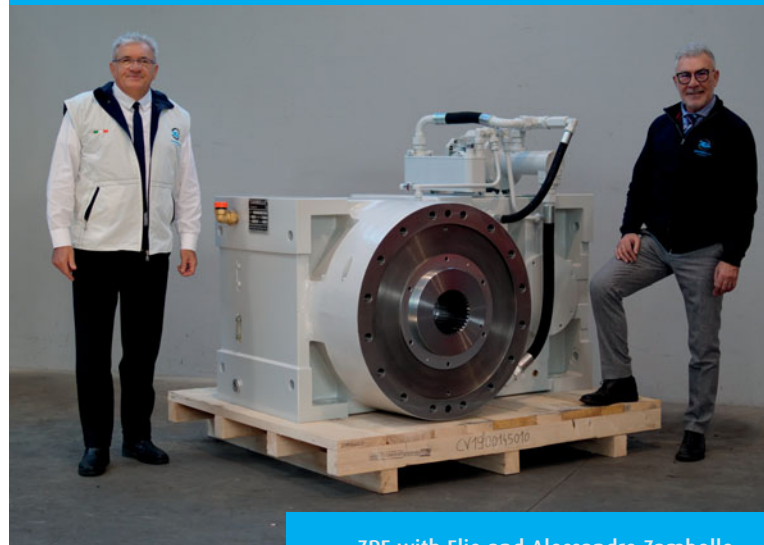

ZPE with Elio and Alessandro Zambello

ZPE series

In 1994 we designed and produced the first single screw extruder gearbox with “universal positioning”.

Today, 26 years later, **ZPE** is the world’s most imitated gearbox for single screw extruders in the market.

Beware of imitations

*a Family Company
since 1957, made in Italy*

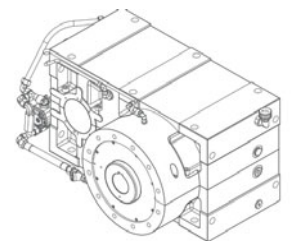

ZAMBELLO group
Advanced technology for extruders
www.zambello.com

Compact with New Cooling Option



With the new internal ventilation cooling option, Baumüller has made its three-phase current synchronous motors even more compact. The fan motor in the classic solution on the right in the picture leads to an interfering contour, which the new version (left) does not have

■ Baumüller, the drive and automation specialist, offers its DS2 three-phase current synchronous motors with four different cooling options. In addition to the radial air-cooled, axial air-cooled and water-cooled options, the variant with integrated fan is now available for sizes 132 and 160.

The great advantage of the integrated fan compared to classic fan cooling is its compactness. The integration of a special built-in motor eliminates the need for the conventional mounted fan motor. The fan motors often prove cumbersome when integrated into the machine, unnecessarily enlarging the footprint of the machines. Internal ventilation is particularly suitable for applications with high overloads or high effective torque and short cycle times, such as in blow molding machines or servo-hydraulic drives.

■ Baumüller Gruppe
www.baumueller.com

Cooperation with Research Institutes of Sweden

■ Orion Engineered Carbons, a leading global supplier of specialty and high-performance carbon black, has partnered with RISE Research Institutes of Sweden in a project to develop and produce renewable carbon black. This collaboration represents an important step towards more climate-neutral carbon black production by replacing traditional carbon black feedstock with pyrolysis oil from biomass oil. Orion plans to convert the biomass oil into carbon black using its small-scale furnace reactor in Kalscheuren, Germany and will explore ways to upscale the process to match market demands. Additionally, using a pilot-scale reactor at its site in Piteå, Sweden, RISE will evaluate the use of electrofuels, such as plasma or hydrogen from electrolysis, as sustainable heat sources for the carbon black process.

“We are committed to meeting the rising interest in renewable carbon black as the tire industry works to address its long-term goal of reducing fossil-derived feedstocks across the supply chain,” said David Deters, senior vice president, Orion Engineered Carbons. “This partnership is yet another step in our sustainability strategy and we look forward to partnering with RISE on this exciting and critically important project.”

RISE has already shown that it could be economically feasible to produce carbon black using pyrolysis oil from wood-derived feedstock. Orion’s project goal is to validate commercial production based on this research.

■ Orion Engineered Carbons
orioncarbons.com

Size Reduction Technology Solves the Resource Dilemma

■ Since the beginning of the year, trade associations and the media have been warning against the continuing raw material shortage in the plastics material field. Where plastics supplies fail, production- and delivery capacities are endangered, prices are drastically increasing. Pallmann size reduction technology unlocks solutions which also consider the aspects of sustainability.

Cutting, agglomerating, fine grinding – with these core competencies, Pallmann, the specialist for size reduction technology, within the Siempelkamp Group, offers a solution to the raw material crisis which presently affects all areas of the plastics processing industry. The concept: Recycles, which arise during production in many companies of all sizes, are processed with Pallmann equipment into new raw material in form of granules or powder, which can be reintroduced

into the production process instead of buying expensive new materials.

The Pallmann machine family number 1, which is valuable to this purpose, is dedicated to cutting. Clean production waste – i.e. purgings, edge trimmings and rejects can be cut with Pallmann knife mills to a size of approximately 5 to 10 mm. Thanks to the special cutting geometry, homogeneous materials with minimum fines are produced and can be reintroduced into production just as new material. The advantages: Reject material from production leads to less waste, less new material and thereby to more internal profit. „In case larger waste products cannot be reused internally, cutting allows for a reduction in volume, which pays off in transport- and disposal costs. Where appropriate, a cut product can be resold to other companies for new applications. This is linked to external profit based on

an alleged waste product”, so Michel Marchal, International Sales Director at Pallmann.

Even more interesting for in-house recycling is machine family number 2, which is dedicated to agglomeration. The Pallmann Plast-Agglomerator System, PFV, generates flowable granules with high bulk density from light-weight materials. Here, processing takes place under the melting point, thus material is not thermally stressed. The agglomerates can also be produced from mixed products, i.e. from different plastic materials, additives and fillers. Pure production waste such as film, fibers and foam are reusable up to 100 percent. Production waste consisting of numerous plastics or which contains other materials – such as additives, and fillers like minerals and paper – can be transformed into granules which can be used as filler and therefore new additives or fillers are no longer required.

Fine grinding is the specialty of the third Pallmann machine family, which makes in-house recycling so interesting. Some applications require powders with a fineness of 0,5 to 1 mm. This is achieved through fine grinding of new material – granulate of 3 to 5 mm. If new material is scarce or more expensive, powder is consequently more expensive; the production step from granule to power alone costs up to 30 cents per kg – as a surcharge on granulate pricing. With the Pallmann Disc Mill PKM, a perfect powder can be produced in-house – whether

from new material or alternatively from clean recycled material. „In many countries the “Pallmann powder” has become a reference. Our customers demand a Pallmann quality powder, most powder suppliers use our PKM in order to achieve the special powder characteristics”, states Michel Marchal.

*Pallmann
Plast-
Agglomerator
System, PFV 315*



G. Siempelkamp GmbH & Co. KG
www.siempelkamp.com



Working for a better future

www.ngr-world.com

MEMBER OF NEXT GENERATION GROUP



FAKUMA
12.-16.10.2021
Friedrichshafen · Booth A5-5108



NXT:GRAN SHREDDER-FEEDER-EXTRUDER COMBINATION

Customized recycling technology for the plastics converting industry. It will not only satisfy, but also inspire.

Sustainable Polyamide

■ DOMO Chemicals has begun using a new sustainable black masterbatch based on recycled material to complement the recycled base polymer in its ECONAMID® brand of sustainable polyamides. ECONAMID®, based on recycled industrial waste, is a benchmark in the industry when it comes to performance level and quality consistency, lot after lot.

The new ingredient is Cabot Corporation's TECHBLAK™ PE1003 black masterbatch. This uses a post-industrial recycled PE carrier as an alternative to virgin polymer, with similar mechanical processing characteristics. TECHBLAK™ PE1003 black masterbatch has been developed for standard compounding and is specifically designed to help the industry lower its carbon footprint, as well as increase the amount of recycled content in end products.

The introduction of this new recycled masterbatch helps meet the evolving circularity needs of the plastics industry and helps the company support sustainability targets across a wide variety of industries, while maintaining optimal performance.

■ DOMO Chemicals GmbH
www.domochemicals.com

E-LOOP Products with Recycled Content

■ ELIX Polymers has included all of its Circular Economy activities under the new brand name, E-LOOP, which was launched successfully last February. The E-LOOP brand includes two strategic programmes of ELIX Sustainable Portfolio Solutions: Circular Plastics and Responsible Innovation.

In October 2020, ELIX obtained the ISCC Plus certification for its production facility in Tarragona, Spain. ISCC (International Sustainability & Carbon Certification) is a globally applicable sustainability certification system that covers all sustainable feedstocks, including circular and bio-based materials and renewables.

The first products are already commercially available, and the first volumes of E-LOOP H801 MR black and M220 CR25 have been produced and validated by customers from the Automotive and Toy Industries, which have shown an interest in implementing these more sustainable solutions as a part of their own Circular Economy strategies to achieve their sustainability goals. E-LOOP H801 MR is a product that contains mechanically recycled material, and E-LOOP M220 CR25 is a product that contains sustainable feedstocks certified under ISCC Plus. ELIX receives these recycled feedstocks from its established suppliers as a result of close cooperation based on long-term agreements.

■ ELIX Polymers
www.elix-polymers.com/sustainability-report/economy

PURITY SCANNER ADVANCED to ensure the Highest Purity of XLPE Pellets used in China

■ A large and successful Chinese manufacturer and global supplier of XLPE HV and EHV power cables, has been using the PURITY SCANNER ADVANCED from SIKORA for quality assurance of high voltage cables in their production lines, since 2017. The Chinese company has been ranking among the top 10 competitive enterprises in the cable industry for many years.

For some years, the company has also been active in the business of manufacturing subsea cables and integrated among others the PURITY SCANNER ADVANCED from the German based SIKORA for quality control in its production lines.

SIKORA's PURITY SCANNER ADVANCED installed at a Chinese manufacturer of HV, EHV and subsea cables for inspection and sorting of XLPE pellets



Reliability is the most important aspect, when selling subsea cable. Typically, the company offers certain years of warranty for this type of cable. "We cannot take any chances at the production of subsea cables", explains the plant manager. "Each production step needs to be safe. It starts with the compound that we use for the cable insulation. Accordingly, we have implemented an online quality control of the XLPE material", he concludes, whereby the company relies on the PURITY SCANNER ADVANCED for inspection and sorting from SIKORA. By means of X-ray technology and optical cameras, the system reliably detects contamination inside XLPE pellets as well as on their surface. Contaminated pellets are automatically sorted out.

The Chinese cable manufacturer installed the PURITY SCANNER ADVANCED in the submarine cable production line and equipped the system also in another production line at the beginning of 2021 to ensure the highest XLPE purity, a high-quality final cable and the highest customer satisfaction.

SIKORA is proud to be a partner of the Chinese global player also in this important project. Both companies have already been cooperating for more than twenty years in the area of online diameter, wall thickness and eccentricity measurement.

■ SIKORA AG
SIKORA (Fuzhou) Electronic Technology Co., Ltd.
www.sikora.net

plast
EXPO UA

XIV International Specialized Exhibition
of equipment and technologies for plastics
and rubber production and processing

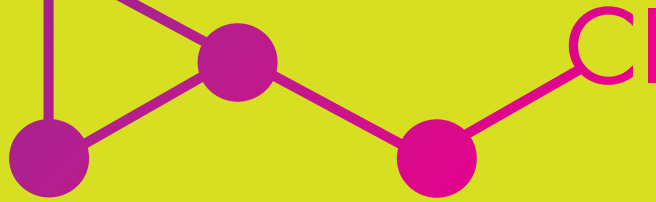

PU Fest
UKRAINE
2022

INTERNATIONAL BUSINESS
FORUM FOR SPECIALISTS IN
THE FIELD OF POLYURETHANES

INTERNATIONAL EXHIBITION CENTRE

15 Brovarskyi Ave., Kyiv, Ukraine
Tel.: +38 044 201 11 56, 201 11 58, 201 11 65
e-mail: plast@iec-expo.com.ua
www.iec-expo.com.ua, www.tech-expo.com.ua

**April 5–7
2022**

General Information Partner: 

Technical partner: 

We PET the Future

Example of use – ECON PET-Edition:
EUP 600 – EVT 350 – ECS 1500

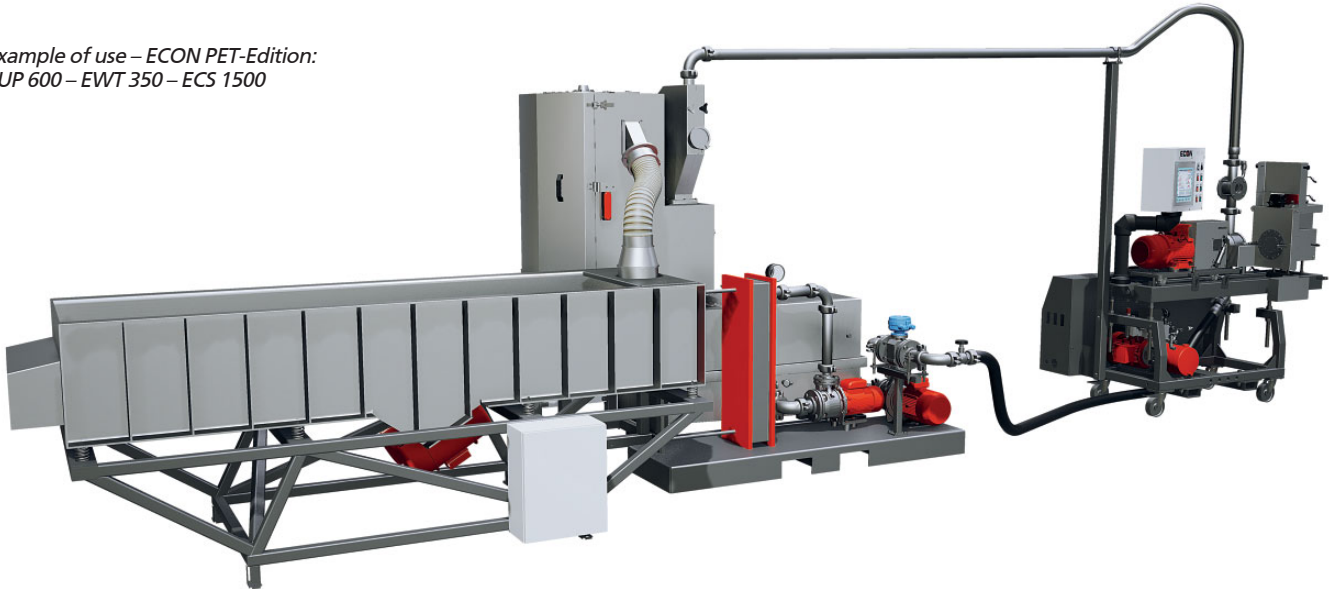

In a world in which circular economy and sustainability are getting more and more important, the reuse of PET is essential. Especially to produce packaging, recycled PET is becoming increasingly important. After all, most PET bottles put into circulation now consist of a high percentage of recycled material – and the amount is rising. In the so-called bottle-to-bottle process, the bottles are purified for use.

The loop starts with the sorting and cleaning of the PET bottles which are then shred into PET flakes - that become the base material for the recycling process. In the next step, the pre-sorted material pass through a multi-stage filtering process in which contaminants like metal, foreign colors and other polymers are removed. After this step, the flakes are melted in an extruder, purified if necessary and cut into pellets by means of an underwater pelletizer

Polymer melt from recycling processes usually contain a high degree of contamination, which makes it impossible to reuse the polymer for the food sector. ECON offers the solution for this problem – the ESD (discontinuous screen changer) is a single-piston screen changer that provides high-quality melt filtration for low-contaminated raw materials such as polyolefins, standard plas-

tics, engineering plastics and high-temperature plastics.

In case of highly contaminated polymers, especially from recycling, ECON recommends the ESK (continuous screen changer) which is equipped with two pistons and allows the screen to be changed during production. ECON also offers backflush equipment (ESK-B) for this product, which cleans the

screens during the pelletizing process and thus extends their service life considerably.

Another concern for this process is melt pressure and how it can fluctuate while being filtered, which can affect pelletizing. To ensure a constant pressure for filtration and the pelletizing process, ECON offers melt pumps with a throughput range of up to 12,000 kg/h.

Finally, to be used in combination with the ECON Melt Pump and the ECON Screen Changer is the ECON PET-Edition pelletizer, which is going to produce high-quality recycled PET pellets.

ECON Pelletizing Systems stand out on their own by the patented Thermal Insulation Technology, which prevents freezing of the die holes and reduces high amounts of off-spec material. "The insulation also prevents the heat flow into the process water which saves energy. When it comes to PET recycling, the kW/t of recycled material has a significant impact on the profitability of the production line. This means that using the ECON Technology results in a significant competitive advantage", says Gerhard Hemetsberger (Head of Sales).

In addition, the ECON PET-Edition is designed to keep the pellet at a high end temperature (at least 140 °C).



Example of use PET: amorphous pellets on the left, semicrystalline pellets on the right

During the developmental stage, special attention is paid to the insulation of the water tank and the piping. Depending on the requirement of the customer, the design of the piping is calculated by ECON in order

to achieve the desired end temperature after drying the pellets. Once dried and still at temperature the pellets are transferred to the ECS (ECON Crystallization Systems) which keeps the PET at a constant

MOLECOR
Orienting the future

TOM[®]

**PVC-O pipes of the highest quality.
Product guaranteed 50 years**

50 TOM PVC-O Pipes **YEAR WARRANTY**

Maximum resistance to impact | Long useful life | Great ductility

Higher hydraulic capacity | Full watertight | Maximum resistance to water hammer

Unbeatable physical and mechanical properties

The best alternative for the conveyance of water under pressure

The most efficient and environmentally friendly solution

From PN12.5 up to PN25 bar | From DN90 up to DN800 mm

info@molecor.com | www.molecor.com | +34 911 337 090

Guarantee exclusively applicable to PVC-O pipes manufactured in the Loeches production center (Madrid) with AENOR Product Certificate No. 001/007104 in accordance with UNE-EN 17176: 2019

temperature to initiate the crystallization process. In this way a degree of crystallization of 30% to 40% is achieved. In the crystallization channel, the pellets are conveyed further by gentle vibration and mixed to prevent sticking during crystallization. Dominik Neumann (Team Leader R&D) mentions, "A high degree of crystallization is necessary to avoid agglomeration, which occurs with amorphous PET during the end use of the pellets (injection moulding). By using the ECON Crystallization System, a pre-drying of the pellets is no longer necessary. The system uses the intrinsic heat of the pellets for crystallization and is therefore one of the most efficient methods of crystallizing PET."

In summary **the ECON PET-Edition makes it possible to filter, pelletize and crystallize PET in just one-step**, and using an underwater pelletizing system instead of a conventional strand pelletizing system provides major advantages:

- pelletizing, drying and crystallizing in only one production step
- no vacuoles – high-quality pellets
- high throughput – little space requirements
- high process stability – consistent pellet quality
- simple and safe start-up process

After pelletizing, the PET recyclate is sent to a deep cleaning reactor. This process purifies the pellets so they can be reused for packaging in the food sector. At this point, the bottle-to-bottle loop comes to an end.

ECON Pyrolysis Furnace for Screws, EPOS



Dominik Neumann (Team Leader R&D)



Gerhard Hemetsberger (Head of Sales)

Another important area in PET recycling is increasing the intrinsic viscosity (IV). For this purpose, various approaches are available on the market:

• **SSP process:**

In the Solid State Polycondensation process (SSP), PET pellets or PET flakes are kept in a vacuum or inert gas for a few hours at temperatures of 200 °C to 240 °C. In this way, the molecular chains are lengthened, and harmful components are removed. As the name suggests, the process is carried out in the solid state of PET.

• **LSP process:**

In the Liquid State Polycondensation process (LSP), the PET is condensed in the liquid state under vacuum to lengthen the molecular chains. This increases the IV value and removes

harmful chemicals from the recyclate so that it can be used again in the food sector. The continuous process means that – in contrast to the SSP process – the desired IV can be kept constant and the process saves time and energy.

Besides the equipment mentioned above, ECON offers air pelletizing systems, hybrid pelletizing systems and pyrolysis furnaces. Visitors to this year's **Fakuma** have the opportunity to experience the unique ECON Pelletizing Technology in a live demonstration in **Hall A6, Booth 6107**. On display will be an *EUP 10 Advanced*, which has been designed to meet the requirements of a 24/7 production. Due to the simple operation and the use of the ECON Thermal Insulation Technology this machine is ideal for small throughputs. Furthermore, the *ECON Pyrolysis Furnace for Screws (EPOS)* will be exhibited, which has been developed for an environmentally friendly cleaning of extruder screws.

Underwater Pelletizer EUP 10 Advanced



ECON GmbH – Fakuma
Hall/Stand No. A6-6107,
October 12 – 16 2021,
Friedrichshafen, Germany
www.econ.eu



Compact Two-in-One System for Round Product Inspection – AllRoundDia DualVision

The AllRoundDia DualVision inspection system for round products is the first of its kind able to perform surface inspection and dimension measurement simultaneously by just one common sensor head. A display shows the measured data in real time. Thus, flaws can be detected immediately and process control adapted accordingly in a swift and efficient manner

For everything round: AllRoundDia DualVision can measure diameters and ovality and inspect the complete surfaces of round products of a wide range of materials



AllRoundDia Dual Vision (DV) is based on PIXARGUS' successful and proven ProfilControl-7 technology. Adapted and further optimized for the measurement of plain round shapes, the new system expands the limits of round product inspection. It combines high-performance technology with an extremely compact design. The camera frequency is software-controlled. Therefore, the system no longer needs an external encoder. This makes AllRoundDia DV more flexible to use, as it can be easily switched between

AllRoundDia DualVision – the first ever system combining complete 360° contour measurement and surface inspection of round products within one simultaneous process. Further performance-enhancing features of the system are its intuitive HMI and the ease of being integrated into the production line



lines. The system comes with a straightforward and intuitive HMI. It can be operated either directly via its display or remotely via a tablet PC.

High-performance lighting concept detects high-contrast defects down to 0.1 mm

The Two-in-One system uses "real" LED light for surface inspection, unlike conventional systems which work on laser-light basis. Due to the newly developed lighting concept, the field of vision and the measuring field are always perfectly lit. Precisely for this reason, even difficult to detect irregularities and flaws in the material, such as fissures, inclusions, flecks and other high-contrast defects from a size down to 0.1 mm, can be reliably detected.

Gapless 360-degree inspection of products with round and oval contours

The camera-based dimension measurement uses laser triangulation. This makes it the first ever system capable of measuring products with round and oval contours gaplessly around their complete circumference. While conventional axis-based measurements using the shadowing method cover only six single points, the optical sensors of AllRoundDia DV can capture 4 million pixels. This enables them to dependably detect even smallest topographic flaws.

As a Windows-based system, AllRoundDia DV comes with all common interface ports and is easily integrated into corporate network structures.

PIXARGUS GmbH
 Industriepark Aachener Kreuz
 Monnetstr. 2, 52146 Würselen, Germany
www.pixargus.de

Oriented PVC Pipes and Fittings within Circular Economy, Eco-Design as Main Drive



Resource's crisis, Climate Change problems, and the need for an economic growth, have led to emerge a new strategy, the Circular Economy, which aim is to reduce materials consumption and waste production, closing the circle of economic and ecological flow of resources

The Circular Economy is the one in which the available resources are maximized, both materials and energy, so that they remain in the productive cycle for as long as possible, the aim of the circular economy is to reduce waste generation and to take the maximum advantage of those that could not be avoided. In addition, circular economy not only presents environmental benefits related to correct management of waste. Soil protection, water, air, or climate provide economic and social benefits too.

Another point to bear in mind is that not only the recovery of waste must be increased, but also, and this is key in this new model, it is necessary to introduce changes in the stages prior to the generation of waste, such as the conception, design, production, distribution, and consumption of products.

Some of the measures proposed by the European Commission are for example: zero plastics in landfills or high recycling rates of materials, for which measures will have to be taken to promote recycling. An important concept to be considered by plastic manufacturers is the concept of Extended Producer Responsibility, for which measures will have to be defined to be applied to producers that subsequently generate waste, to ensure their involvement in closing the loop; these measures will have to do with the eco-design of products to improve their durability, energy efficiency and low environmental impact.

Molecor products, TOM® pipes, manufactured from DN90 mm to DN1000 mm in nominal pressures from 12.5 to 25 bar, and ecoFIT-TOM® fittings, produced from DN110 mm to DN400 mm in PN16 bar, are one of the most environmentally friendly solution available in the market, because of their lower energy consumption throughout their long life cycle, lower greenhouse gas emissions into the atmosphere and, therefore, a lower Carbon Footprint than alternative

materials, as well as a lower impact on climate change. Additionally, it has also been proven that the environmental impact they show, not only in global warming, but also in other environmental impacts such as the destruction of the ozone layer, is also lower than other materials. For Molecor, the preservation of the environment is an issue of great importance, that is why it has obtained the Environmental Footprint seal from the Sustainable Life Foundation by calculating the environmental footprint of its TOM® pipes and ecoFITTOM® fittings in accordance with the new Recommendation 179/2013CE proposed by the European Commission for the calculation of environmental footprints.

Environmental impact of Oriented PVC pipes and fittings

PVC-O pipes and fittings are the most ecological solution due to their better contribution to a correct sustainable development planet, as shown by different world studies, among which we can highlight: Energy consumption estimation and CO2 emissions associated to their production, use and final disposal of PVC, PEHD, PP, Cast Iron and Concrete pipes (Polytechnic University of Catalonia) and the Oriented PVC Environmental Product Declaration TEPPFA study.

These are some environmental advantages that Oriented PVC pipes and fittings present: Speaking about natural resource efficiency, there are several examples. The first one is about the quantity of petroleum is needed. Only 43% of the composition of PVC depends on it, therefore, efficiency is obtained compared to polyolefin pipes which derive 100% from the same. Oriented PVC pipes and fittings (PVC-O) are manufactured by a conventional extrusion process and subsequent molecular orientation, which improve the mechanical properties of the product and all of this, with a smaller quantity of raw



INSPECT MORE



Optical Inline Inspection of extruded products

Small-budget solutions

Surface.
Geometry.
All-In-One.

material, pipes and fittings with better performance are obtained. In relation to the energy consumption, it is lower in the extraction of the raw material, the pipe manufacture, and its use in networks. Moreover, PVC is a 100% recyclable material that can be reused. This reduces the consumption of virgin raw materials and the volume of waste generated also.

In relation to the topic optimization of water resources, PVC-O is chemically inert to the products present in nature and therefore remains unaltered. This fact, together with the effective design of its socket, avoids leakage of the channelled water and contamination of the fluid circulating inside it, maintaining at the same time, a total water quality.

TOM® PVC-O pipes and ecoFIT-TOM® PVC-O fittings have a very long service life thanks to their excellent mechanical properties. That is the reason why breaks during handling and installation on site are minimal, reducing the need to replace damaged products in the network with the consequent saving of economic resources.

Between their advantages and contribution to sustainability is a lower carbon footprint. Due to the lower CO₂ emissions

into the atmosphere, as shown by various international studies, and throughout their long useful life they consume less energy, minimizing the effect on the planet's climate change. With the optimization of transport, thanks to the lighter pipes and fittings' weight, it is possible to save fuel and minimize CO₂ emissions too.

According to Teppfa's environmental product declaration (EPD), PVC-O pipes have a lower environmental impact, not only on global warming, but also on other environmental parameters such as acidification or the destruction of the ozone layer.

Molecor and the SDG

Molecor, as a company, and its fittings and pipes, as products, are aligned with the UN Sustainable Development Goals, with the aim of achieving a sustainable future for all. Sustainable Development Goals are interrelated, and they incorporate the global challenges we face every day, such as poverty, inequality, climate, environmental degradation, prosperity, peace and justice.

The main one for Molecor is number 6, related to clean water and sanitation because TOM® pipes and ecoFITTOM® fittings are the epicenter of the company. Both are products with a long service life, which ensure total water quality.

In line with SDG number 7, related to affordable and non-polluting energy, Molecor has a strong commitment to the responsible consumption and use of energy, thanks to its highly energy-efficient production process and the lately increase in the percentage of energy consumed from renewable sources.

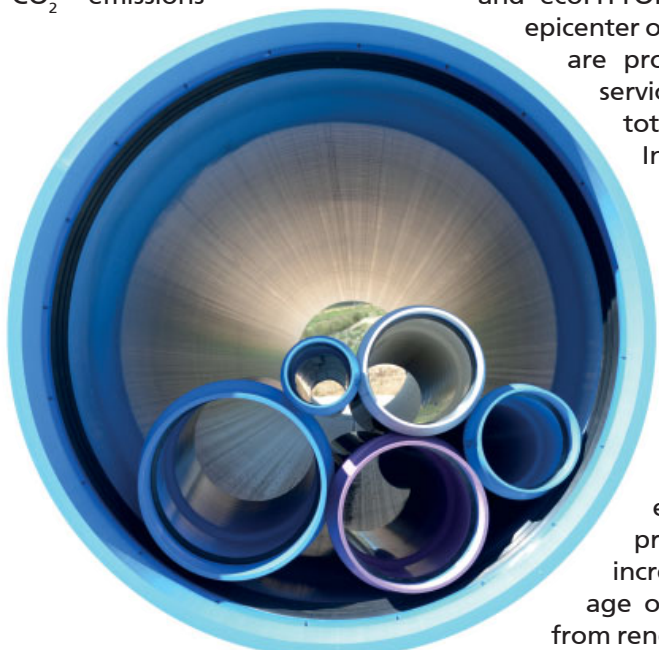

Innovation and infrastructure, as stated in SDG 9, are in Molecor's DNA, as a leader in Oriented PVC, with its own patented technology and the continuous incorporation of new products.

Molecor contributes to SDG 12, related to responsible production and consumption, with a Quality and Environmental Management System in accordance with regulations, and other environmental studies. Molecor contributes to number 11 by ensuring that TOM® pipes and ecoFITTOM® fittings enable sustainable environments to be built.

Regarding climate action (SDG 13), underwater life (SDG 14) and the life of terrestrial ecosystems (SDG 15), Molecor makes a major contribution to the sustainable development of the planet through all the impacts mentioned above.

Finally, the company is part of various sectoral associations or voluntary programs with the aim of achieving sustainable partnerships, which is related to SDG 11.

Corrugated pipes, which are used worldwide in water management and drainage systems and as cable conduits, require high melt quality and perfect homogeneity during extrusion. For this very reason, Fränkische Rohrwerke Gebr. Kirchner GmbH & Co. KG, based in Königsberg/Bavaria, recently decided to purchase a new-generation conEX from battenfeld-cincinnati Austria GmbH, located in Vienna. The pipe manufacturer used this extruder to replace an older model in an existing extrusion line and was then immediately able to meet all requirements in terms of quality standards and output



Conical twin screw extruder conEX NG 65

conEX NG Proves its Quality in Corrugated Pipe Extrusion

FRÄNKISCHE is a family-owned company founded more than 100 years ago, today employing more than 4,500 associates at a total of 22 production plants, and it is famous for its innovative system solutions in building construction and civil engineering as well as the automotive and industrial sectors. One of the company's core product lines are corrugated pipes made of PVC, which serve as water management and drainage pipes, as well as cable conduits. While the cable conduit pipes range from DN 40 to DN 200 in nominal width, the pipe manufacturer makes water management and drainage pipes for road construction, agricultural drainage, drainage of buildings, landscaping and construction of sports facilities, as well as sewerage systems, which reach up to 800 mm in diameter. Depending on the application and on customers' wishes, these pipes meet all demands in terms of load capacity and laying attributes.

For its corrugated pipe production, FRÄNKISCHE uses several extruders from battenfeld-cincinnati. The pipe manufacturer has already maintained a customer-supplier relationship based on mutual trust for more than 25 years. Following a modernization of its machinery and equipment already implemented by battenfeld-cincinnati over the last few years, FRÄNKISCHE now decided to acquire the conical twin screw extruder model conEX NG 65. It has replaced an extruder in an existing line which was about 18 years old, with very satisfying results. Frank Beck, Head of Operations und Supply Chain Building

Construction at FRÄNKISCHE, expresses this as follows: "The extruder is equipped with a screw optimized for the application. We are really enthusiastic about this high-precision job in terms of melt homogeneity and product quality." With this acquisition, FRÄNKISCHE is now one of some 100 customers who are operating a conEX NG and are very satisfied with its performance.

Five years have now passed since battenfeld-cincinnati launched conEX NG, a series of three conical twin screw extruder models setting themselves apart from their predecessor versions by a completely revised and optimized processing unit. Their characteristics include the ability to process an enormous range of different PVC types as well as to withstand high tooling pressures of up to 520 bar. The extruders come with a lengthened preheating zone and an optimized screw design to provide high output rates combined with optimal melt quality. Additional advantages of this conEX version are a reduced footprint, lower investment costs in relation to output rates, and a lower energy consumption than the predecessor model.

battenfeld-cincinnati Austria GmbH
Wien, Austria
www.battenfeld-cincinnati.com

FRÄNKISCHE Rohrwerke Gebr. Kirchner GmbH & Co. KG
Königsberg, Bavaria, Germany
www.fraenkische.com

„Growing Range of Large Format Profiles“ *Large investment programme implemented*

Currently, SLS is positioning itself to further expand into the plastic extrusion markets by investing into production, tool shop and e-mobility and by planning a new building. In the course of these measures, the manufacturer of profiles is implementing numerous process optimisations and expanding the possibilities of customised packaging and finishing of its products. Read here what the expectations of the German family business are in this connection

Geometrically complex window profiles, innovative hard-soft profiles, high temperature proof or conductive plastic profiles – SLS produces hollow or solid profiles from many engineering plastics (Picture: SLS)

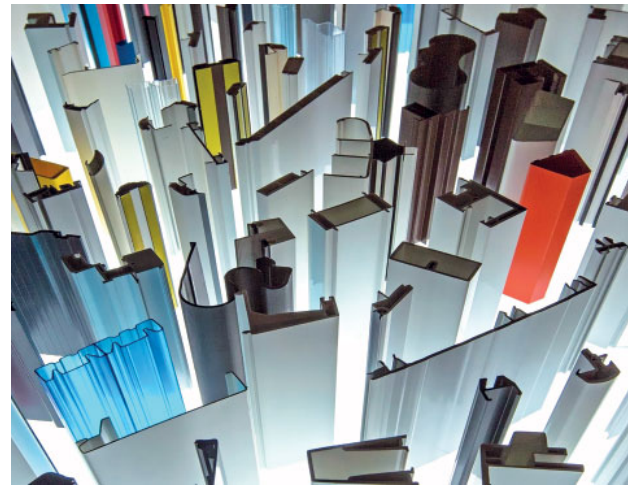

Geometrically complex window profiles, innovative hard-soft profiles, high temperature proof or conductive plastic profiles – this is just a small number of examples of the wide range of products from plastic extrusion expert SLS. The family company located in Dahn manufactures profiles and profile systems for customers in the fields of window and door construction, vehicle manufacturing, electrical engineering, packaging, medical technology and many

In the past weeks, SLS did not only put into operation two new extrusion lines but also a new handling equipment for safe handling of large profiles and a walk-on platform (pictured) to better load the system (Picture: SLS)



more industries. Since the company was founded in 1985, it has been implementing substantial investment and modernisation programmes at regular and short intervals that safeguard the future of the company and expand its performance. At present, SLS is implementing many measures and projects to strengthen itself for the further expansion in the European markets. In the past weeks, SLS put into operation two new extrusion lines including downstream equipment (calibration, haul-off, cutter, etc.), a new handling equipment for safe handling of large profiles and a walk-on platform to better load the system. Managing

Managing Director Jan Leibrock: „The construction of another hall shows our commitment to our location in the beautiful region of the Dahn Rockland but also takes account of the fact that there is a steadily increasing demand for customer-specific partially processed profile systems“ (Picture: SLS)



Director Jan Leibrock explains: „These new facilities allow us to increase our production capacity and we now have a total of 32 extrusion, co-extrusion and tri-extrusion lines to manufacture rigid and elastic solid and hollow profiles. And thanks to our new handling equipment and the new platform, we were able to save some storage space and optimise numerous peripheral material flow processes.“

New machines and further digitisation

In order to meet the high capacity demand, SLS's in-house tool shop will get a new addition: In the coming days another CNC-machining centre will be installed enabling the company to meet the growing demands for geometric complexity of the profiles even more effectively. „As a result, we are once again strengthening our position as development partner for our customers“, Jan Leibrock says. In addition, the further digitisation is being continued in all areas and departments. Currently, the main focus of activity is on further extensions of our enterprise resource planning system, project management and time recording. Furthermore, we are planning to install charging points for our company and customer electric and hybrid vehicles.

A new building for finishing and packaging

One key aspect in the current investment programme of SLS is the construction of another hall which will be exclu-

The two new extrusion lines of SLS include tailor-made downstream equipment including calibration, haul-off and cutter (Picture: SLS)



With the acquisition of two new extruders from HansWeber (pictured), SLS is increasing its production capacities and now has a total of 32 extrusion, co-extrusion and tri-extrusion lines to manufacture rigid and elastic solid and hollow profiles (Picture: Hans Weber Maschinenfabrik)

sively dedicated to the finishing and packaging section of profiles. Jan Leibrock explains: “Not only does this eighth new building project in our company's history show our commitment to our location in the beautiful region of the Dahn Rockland but also takes account of the fact that there is a steadily increasing demand for customer-specific partially processed, preassembled, refined and packed profile systems and special-purpose solutions“. Several years ago, SLS – as a supply partner with a clear customer orientation – started to pay more attention to the finishing and packaging of its profiles. Many customers have gladly accepted the expansion of the service range at this point to release their own capacities. “The finishing and packaging sector is also getting a considerable impetus for demand from our growing range of large and heavy profiles – for instance for the construction industry“, Jan Leibrock reports. If possible, the commissioning of the new hall should take place before the turn of the year. SLS produces hollow or solid profiles from many engineering plastics ranging from hard PVC, soft PVC and ASA via PE, PP, PS, POM, SBR and ABS up to different polymer blends. In addition, the production of sophisticated hard-soft combinations is one of the company's core competencies, and for applications with increased strength requirements it also implements composite solutions with glass fibre, aluminium and steel.

*Author:
Manfred Stiller,
freelance technical journalist, Darmstadt*

Mono-Material Films – Solutions for a Circular Economy

Packaging Design for High-Quality Recycling Streams

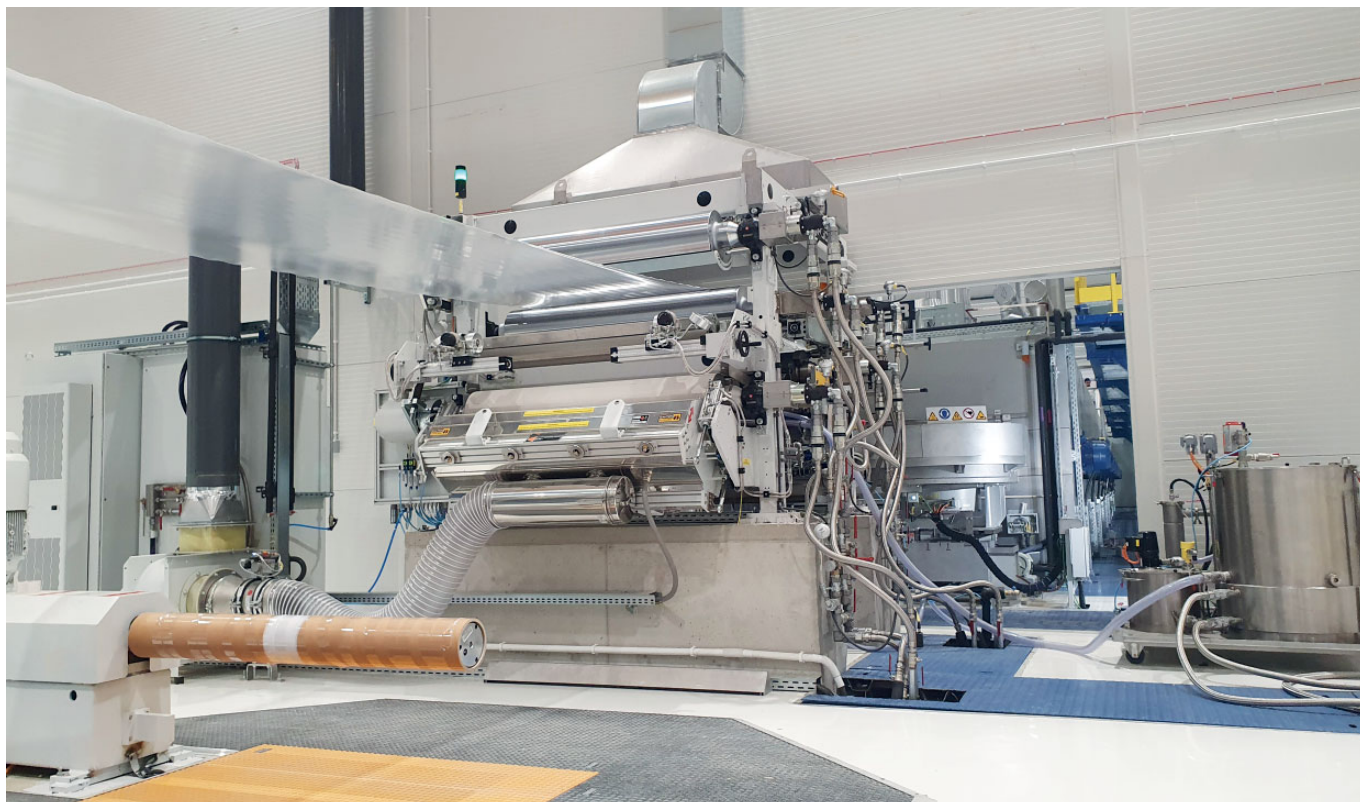

Today, many packaging structures use composite structures made of various films and various materials. These laminates ideally combine the required properties such as high barrier, sealability, thermal stability, puncture resistance, printability and many more. Unfortunately these multi-material structures cannot be sorted to a certain recycling fraction and are difficult or even not all to recycle

Therefore, companies along the entire value chain of the packaging industry put their focus on mono-material structures, which will be able to substitute multi-material films and laminates. These mono-solutions enable the way to a circular economy because they are ideal for the use in new applications since they guaran-

tee good sortability in waste separation and high-grade recycling material quality.

Brückner Maschinenbau has developed mono-material packaging solutions to close the life cycle of plastic packaging as requested by brand owners and legislations. Besides the state-of-the-art materials BOPP and

BOPET, a new opportunity is opening up with BOPE.

BOPP films: Great potential for high value second life products

PP (polypropylene) is a very common type of plastic and has many uses in products we use every single day. Benefits are a good chemical

and moisture resistance, as well as a light weight and material strength. PP is excellently recyclable, with a great potential for future high value products. It can be sorted and mixed with the existing PP recycle stream – and there is a large market for PP recycling material: For example in injection moulding, as a substitute for engineering thermoplastics such as ABS and PA, as a housing material for small electrical appliances and in moulded parts for household appliances. The automotive sector needs PP for body parts such as bumpers or in the interior of cars. In the construction sector, PP is used for floors, pipes, containers and garden furniture.

Several developments for PP mono-material packaging have been successfully launched recently: E.g. flexible pouches, where complex laminates are now substituted by all-polypropylene versions based on BOPP and CPP. The switch to PP mono-material structures is giving a good combination in terms of product protection (barrier to humidity, aromas or gases), promotion (matte or glossy, high stiffness, good aesthetics and haptics) and performance (printing, lamination, packaging and filling operations) – even for retortable applications.

BOPET films for an upcoming circular economy

All over the world, BOPET films are a highly esteemed material for vari-



ous applications – with every right to be. In technical applications such as solar panel back sheets, optical film grades, insulations, printed circuits or sequin films their excellent mechanical characteristics, brilliantly clear nature or high temperature stability are unbeaten. For a wide range of packaging solutions, more properties come on top: high barrier features, a good surface treatment suitability or an excellent stiffness, to name only a few.

To make BOPET films also fit for the upcoming circular economy, raw material suppliers, Brückner Maschinenbau, film producers, converters and

brand owners are actively following the idea of PET mono-structures.

Trials on the Brückner laboratory line clearly showed that post-consumer waste recycle PET can be added to the virgin material in a proportion of above 50% without any losses in quality: optics, mechanics and the dimensional stability are absolutely comparable to 100% virgin BOPET. Using certified bottle flakes which are fully food contact approved, the manufactured film is ready for a circular economy and furthermore reduces the carbon footprint.

PET in general is not known for good sealing properties. Members of the

▶ **each detail matters for unrivalled performance**

Only a company who has a constant focus on the productivity of its customers thinks ahead and creates extrusion solutions that leave the rest standing. SML specialises in the development of extrusion lines for film, sheet, coating and lamination as well as multifilament spinning lines.

Extrusion lines. Engineered to perform.

SML
EXTRUSION LINES – ENGINEERED TO PERFORM ▶

www.sml.at

PET value chain, as well as Brückner Maschinenbau, are currently developing measures to change exactly this. An exemplary application for such sealable mono (BO)PET films could be lidding film for a wide variety of thermoformed PET trays and containers or several overwraps in food packaging: a perfect match for easy sorting and recycling. Additionally, BOPET white opaque films with a density below 1 g/cm³ are soon becoming reality.

BOPE – a promise for the future

BOPE films offer completely new possibilities for a sustainable packaging industry. Due to the available, in multiple countries already established PE flexibles recycling stream – the product live circle can be immediately closed.

Two different film qualities are available to the market:

- Sealable BOPE-LLD
- Stiff base film BOPE-HD

Improved by biaxial stretching, BOPE-LLD allows down-gauging in comparison to PE blown film. The sealing performance and seal integrity is superior to BOPP, also puncture resistance and a linear tear behavior for easy opening functionality are beneficial.

BOPE-HD is a stiff printable web and enables in combination with BOPE-LLD or PE blown films real PE monomaterial packaging, providing even high oxygen barrier in combination



with coating or metallizing (Al, AlO_x, SiO_x) technology. This was recently proven by manufacturing a 100% BOPE pouch made of a 3 ply structure: 20 µm BOPE-HD transparent printing film // 20 µm BOPE-HD transparent barrier film // 35 µm BOPE-LLD sealable film.

Some highlights of the all-BOPE pouch are:

- PE Mono-material with high stiffness
- Outstanding opening behavior and linear tear
- High, transparent barrier against oxygen and water vapor

Besides the all-BOPE pouch, more and more packaging structures are being introduced into the market in real applications.

From bilateral teamwork with raw material suppliers, masterbatch specialists, film producers and converters to more complex co-operations along the value chain: Brückner is involved at many levels. Thus, the best possible PE raw material for the biaxial stretching process with optimal film properties has been developed. The results have been transferred from the laboratory scale to production lines by upscaling and finalized in the BOPE/BOPP hybrid line layout.

Bulgarian Plastchim-T as well as Polivouga from Portugal, one of Eu-

rope's top manufacturers of high-quality films and flexible packaging, soon will go on stream with 6.6 m / 8.7 m wide, ultra-flexible BOPP/BOPE hybrid lines for an extended range of biaxially stretched films. As the demand for innovative BOPE films is only now starting to develop, hybrid lines allow to react swiftly and flexible to market trends by also producing BOPP specialties such as UHB films and coated films alongside conventional packaging film. Full output for BOPP, BOPE-LLD as well as BOPE-HD film types is guaranteed, a material change can be handled within a few hours.

The 5-layer machine is additionally equipped with the new Brückner in-line coater, making the production of extremely thin functional layers within the nano-range possible. Thus, the layers don't disrupt the sorting and recycling, but cater, for example, for an improved adherence during metallizing and excellent barriers in combination with the equally thin but effective aluminum oxide coating.



New Recyclable Blister Film Launched

Klöckner Pentaplast (kp) has launched kpNext, its first-to-market innovation in recyclable PET blister films. kpNext is the only PET recyclable blister that is completely compatible on pharmaceutical manufacturing form, fill and seal equipment



kp has a rich history of innovative pharmaceutical blister packaging solutions and kpNext is the next step of that evolution. Not only is kpNext the only PET film designed to be a recyclable blister package, but it does not come at the expense of the manufacturing process. Pharmaceutical companies and converters can utilise kpNext on their existing form, fill and seal lines with no loss of line speed or a need to retool. It truly is the best of both worlds, sustainable yet functional solution.

From consumers to global brands to governments, the demand for recyclable packaging has never been higher. kpNext answers those calls. It is produced from a globally recyclable material and is designed to be recycled in the RIC (resin identification code) #1 PET stream.

Daniel Stagnaro, Head of Technology stated: "Current pharmaceutical blister packaging is classified as RIC #7, produced from a multi material structure, which is not recyclable and therefore is disposed in a landfill or incinerated. Major pharmaceutical companies have been challenging blister manufacturers for a solution that is responsible and recyclable. kp has answered those challenges with kpNext."

kpNext is the culmination of three years' worth of research and development. Utilising its kp i.center, an application development lab located in Charlottesville, VA, kp scien-

tists, chemists and technical teams have worked on developing the technology to where it is today: A blister film designed to be fully recyclable and a plug & play solution on existing pharmaceutical lines.

At launch, Dr. Jorg Schneewind, President of kp's PHD Division said: "kpNext is an example of excellence in product innovation because it has been designed to be recyclable and is a seamless transition, taking the burden off our customers to adapt to the sustainable film. Instead, the film adapted to the equipment. It's a true milestone for the industry and for kp – in our ability to support our customers in meeting their sustainability commitments."

"For over 55 years, kp has been at the forefront of sustainable packaging designs, championing the circular economy and closed-loop recycling while leading in innovative, recycled-content products," said Scott Tracey, CEO of Klöckner Pentaplast. "As a company, we're committed to taking every opportunity to make packaging recyclable. A win-win for our long-term partners."

► KP Holding GmbH & Co. KG
Industriestr. 3-5, 56412 Heiligenroth (Rheinland-Pfalz), Germany
www.kpfilms.com

**You'll find them.
All. With OCS.**



For 100% Purity.

No matter whether you **inspect raw material**, **check the surface** or set up **turnkey laboratories**: OCS develops, builds and supports exactly, what you really need.



Scan and contact us:



www.ocsgmbh.com

The RKW Group invests in a state-of-the-art five-shift extrusion line for the production of industrial plastic packaging at its Echte, Germany site



The RKW Group is investing a seven-figure sum at its Echte, Germany site to produce plastic films with a high recycled content in the future. At the same time, the company is expanding its production capacity in the area of industrial packaging, thus securing jobs in the region. The new five-layer extrusion line is the latest of several investments at the Lower Saxony site

New Five-Layer Extrusion Line Started Up – *Seven-Figure Investment for More Recycling and Sustainability*

The plant in Echte, with over 240 employees, is RKW's centre of competence for industrial packaging. Research, development and production of the so-called FFS and ProVent sacks are located here. Other mainstays of production include valve box sacks, transport packaging and garbage bags. Powdery goods such as cement or other building materials, foodstuffs such as sugar, spices or salt, as well as various chemicals are packaged in quantities of mostly 15 to 25 kilograms in FFS bags and the ProVent developed in Echte.

The new extrusion line will be used for the industrial packaging product group: "We want to offer our customers more sustainable packaging solutions for industrial packaging with new formulations. This includes, for example, a steadily growing proportion of recycled plastics in the packaging. State-of-the-art equipment like this enables us to do that," says Site Director Markus Brinkmann.

During development, RKW keeps the full product life cycle in mind. Accordingly, in addition to robustness and particularly high protection of the goods, the full recyclability of

the films is also very important. This is already ensured by the purity of the material; the films produced are made exclusively of PE. In order to increase the reuse of recyclates without any loss of quality, innovative recipes have to be developed especially for this five-layer extrusion line. Older lines with only three extruders are severely limited in this respect. In addition to the increased use of recyclates, the higher energy efficiency of the plant and the lower production waste also contribute to the sustainability of production. RKW thus makes important contributions to a circular economy.

Sustainability at all levels

Sustainability plays a central role at RKW – and not only in the products. All of the group's sites in Western Europe use electricity exclusively from renewable energy sources. In an energy-intensive industry such as plastics, this switch saves a good 100,000 tonnes of CO₂ emissions per year, or around 60 per cent of RKW's direct emissions worldwide compared to 2019. The other sites are also gradually being converted to green electricity.

To ensure that overall energy requirements are reduced, RKW is focusing on modernisation in production processes and on new, more efficient machines and cooling systems with up-to-date measurement and control technology. At the same time, more and more lighting systems in the factories are being converted to LED. RKW 2020 has invested around 650,000 euros in energy efficiency measures of this kind alone.

The commitment to climate protection plays a major role in RKW's sustainability strategy. But the company is also committed to socially relevant issues such as equality, diversity and inclusion. In July 2021, the owners, Board of Management and top management signed the "Charta for Diversity". Sustainability is a task for society as a whole and it is firmly anchored in the RKW Group. It also creates potential for economic growth, as the investments at RKW in Echte underline.

Heat Resistant and Fully Recyclable – White rPET100 Packaging for Dairy, Hot Drinks and Teady Meals

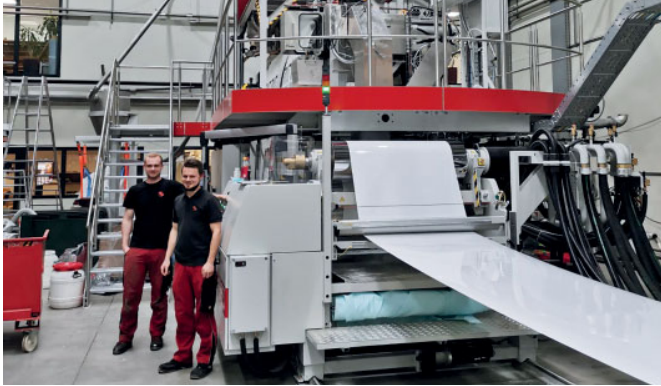

Made from recycled material and designed for recycling: Starlinger viscotec, a division of the Austrian machinery supplier Starlinger & Co GmbH, has developed a new material to make packaging for dairy and hot-fill products fully recyclable. rPET100 combines the environmental advantages of recycled PET with easy material processability and opens opportunities for new circular packaging solutions

Food packaging for applications like dairy, hot drinks, instant soups, and ready-meals must withstand higher temperatures during the production process and consumption. Additionally, dairy products require packaging with optimal light and gas barrier for longer shelf life. The new rPET100 sheet combines these benefits and adds new ones: it is heat resistant, made from mono-material, and its white colour protects the product from UV light. Once used, the packaging can be 100% recycled because it contains no other polymer additives.

Trays, cups, and food containers made from rPET100 are the fully recyclable alternative to single-use cups made from materials like polypropylene (PP) or polystyrene (PS). Post-consumer recycled PET fulfils all requirements of the European Food Safety Agency (efsa) when it has been super-cleaned with Starlinger viscotec technology. PET/rPET has outstanding material properties that can be restored in the recycling process, which makes PET a truly circular packaging material.

With the introduction of the new rPET100 material, Starlinger viscotec puts the “cradle to cradle” principles for a circular economy into action. By using recycled PET for

packaging, a lot of CO₂ emissions are avoided. Up to 100% recycling content is possible for rPET100, giving brand owners and converters an unparalleled opportunity to produce truly sustainable packaging solutions. rPET100 has an unbeatable CO₂ balance because recycled PET has a considerably smaller CO₂ footprint, plus the new material can be fully recycled.

rPET sheet lines by Starlinger viscotec are designed for outstanding sheet quality at high throughput rates. Converters who run Starlinger viscotec equipment can manufacture rPET100 sheet without making changes to the set-up of their installation. Packaging manufacturers appreciate the material properties of the rPET100 sheet, which achieves high output with only minor adjustments to the thermoforming set-up.

Starlinger & Co. Gesellschaft m.b.H. viscotec
Adsdorf 38, 4113, St. Martin im Mühlkreis, Austria
www.viscotec.at



Premium solutions for surface analysis

- Cleanability
- Coatability
- Printability

Visit our online talk

December 8, 2021 | 11.00 AM CET
lab.extrusion-info.com



Circular Economy at Industry Highlight Fakuma 2021

The 27th Fakuma international trade fair for plastics processing extends its invitation to the live trade fair in Friedrichshafen from the 12th through the 16th of October, 2021. In addition to the issues of injection moulding, extrusion technology and thermoforming, the industry high-

light will also focus attention on the digital transformation in the plastics processing industry, as well as the changeover from a linear to a circular economy.

The fully up-to-date range of products and services offered at Fakuma provides machine manufacturers,

users and consumers with new approaches and solutions to issues including sustainability, environmental protection, recycling and circular economy. In addition to production efficiency, the trade fair also focuses on the conservation of resources and the indispensability of plastics in order to be able to achieve established climate goals. "It's plainly apparent that the exhibitors have become increasingly eager to address the currently negative image which is unfortunately associated with plastics," says Annemarie Schur, Fakuma project manager. "The issue of recycling and the transformation from a linear to a circular economy are on the agenda for many companies," continues Schur, "and thus Fakuma will also make a contribution to increasing the awareness of circular economy, recyclability, product life-



cycles and product design to an even greater extent.”

Produce, consume and throw away is a thing of the past. The future calls for transformation to a circular economy. This project for society as a whole, which will change business models, products and services in a sustainable fashion, will be discussed at Fakuma on various levels with the goal of finding and further developing sustainable, viable solutions. Schall trade fair promoters will provide suitable, ideal conditions for efficient, maximised success of on-site, face-to-face expert exchanges. “As the promoters of Fakuma, we are fully aligning ourselves to the hygiene concept adopted by the Friedrichshafen Exhibition Centre,” states Bettina Schall, managing director of P. E. Schall GmbH & Co. KG. “All of the specific measures are



listed here, which have been extensively coordinated with the responsible authorities and implemented on the basis of the generally valid Corona Ordinance of the State of Baden-Württemberg. We of course support this as well, because our ex-

hibitors and expert visitors are very important to us.”
 (https://www.messe-friedrichshafen.com/organizers-service/coronavirus-checklist)

www.fakuma-messe.de

LESUN

New factory New beginning

lesunscrew.com

Plastics Recycling Solutions:

The machine and plant manufacturer from Meckesheim, besides their broad range of machines for the treatment of plastics waste will be presenting at the FAKUMA Trade Show tried-and-tested procedure-oriented solutions.

In case of heavy-duty applications, if powerful machines are needed, only very few providers of size-reduction equipment on the market will be able to present an appropriate answer. Herbold granulators will do the job of all plastic waste.

The key for the efficiency of the Herbold granulators is the rotor design and the special construction design of the granulators in addition to the cutting geometry and the real double cross cutting action. Herbold can offer a multitude of rotor geometries, customized according to the individual application. The entire anti-wear coating of the housings and the exchangeable wear parts of special rotors have scrupulously been thought out and guarantee a long service life of the machines, easy to maintain.

Washing technology

The demand for high-performance and efficient recycling plants is currently extremely high. Projects covering investments of up to 12 million keep surging and high end product qualities are in the focus.

The use of hydrocyclones in separation technology and the hot wash have been important components of the

Modern film washing plant with hot wash step

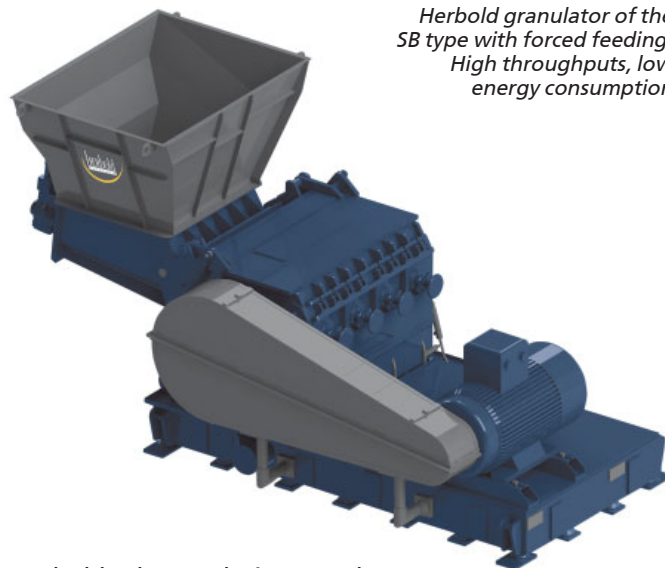

Herbold granulator of the SB type with forced feeding. High throughputs, low energy consumption

Herbold plant solutions and vital criteria of Herbold technology for years. Herbold managed to almost double the business in the last 2 years.

Especially for the following applications Herbold is able to offer tried-and-tested solutions:

- Post-industrial post-consumer film
- Post-consumer rigid plastics
- PET bottles
- PET trays
- Big-bags and other monofilaments
- Bottle crates and pulper residues

The hot wash of film has by now become an essential component in a multitude of orders to yield the wanted high qualities of post-consumer materials. In the PET realm, plant technology continues to be set on efficiency and product output. We can also showcase efficient solutions for PET trays and due to a gentle treatment, only few fines loss in this brittle material flow.

Herbold technology can also be used as a preliminary processing step for chemical recycling. Dry cleansing solutions, wash lines as well as Herbold agglomerators tailor the input material for the chemical procedure solution.

“We are committed to a competent and comprehensive consultation of our customers,” highlights Achim Ebel, Division Manager for Washing Lines – „A ready-made washing line does not exist at Herbold – in cooperation with our customers, it is an individual process to devise a corresponding solution in response to the application.”

Fakuma



Herbold Meckesheim
A6-6312

Herbold Meckesheim GmbH
www.herbold.com

Free Live Material Tests with the PURITY CONCEPT V:



At the Fakuma, SIKORA shows the CENTERWAVE 6000 for quality control during the pipe extrusion

SIKORA will present innovative measuring and control technologies for the tube, hose and pipe industry as well as online and offline systems for the inspection, sorting and analysis of plastic pellets at this years Fakuma. In the area of online inspection and sorting of plastic pellets SIKORA presents the PURITY SCANNER ADVANCED. The system combines in a unique way an X-ray with up to three optical cameras. Thus, even the smallest metal inclusions in the raw material from a size down to 50 µm can be detected. In addition, the optical cameras detect black specks and burns on

SIKORA offers free pellet tests with the PURITY CONCEPT V at the Fakuma



the pellet surface. Defective pellets are separated immediately after detection by means of compressed air. At the Fakuma, SIKORA offers customers free live material tests with the PURITY CONCEPT V. The system is typically used for offline laboratory testing and random sample inspection. Interested customers are invited to bring small pellet samples (approx. 100 g) to the SIKORA booth to have them tested. The automated light table automatically inspects the test material placed on a sample tray within a few seconds by using a color camera and evaluates the image recordings. The system detects black specks and color deviations down to a size of 50 µm and highlights contamination in color on the monitor image and in parallel via a projector on the sample carrier. A clear assignment of the contamination and a follow-up control are thus possible at any time. For a 100 % quality control during pipe extrusion SIKORA presents the CENTERWAVE 6000, which is based on millimeter wave technology. The device precisely measures the diameter,

ovality, wall thickness, inner profile as well as sagging of the pipe. The measuring method does not require any coupling media or calibration and is free from influences such as temperature or the plastic material. Another highlight at the SIKORA booth is the X-RAY 6000 PRO. The X-ray based system measures the wall thickness, eccentricity, inner and outer diameter and ovality of tubes and hoses from 0.65 mm diameter. The thickness of up to three different material layers is measured. Automatic control of the line speed or extruder rpm ensures maximum productivity. SIKORA's presentation at Fakuma is rounded off by reliable diameter measuring systems of the LASER Series 2000 and 6000. The 2-axis or 3-axis gauge heads are predestined for diameter measurement of transparent as well as non-transparent tubes and hoses.

The PURITY SCANNER ADVANCED for online inspection and sorting of plastic pellets



SIKORA
A6-6110

SIKORA AG
www.sikora.net

Innovative MRSjump Extruder with High Decontamination Performance and a Viscosity Boost in One Single Extrusion Step:

Gneuss is presenting its brand new MRSjump extruder at the Fakuma show. As with the proven MRS extruder, the extrusion process does not require any pre-treatment of the input material, such as crystallisation or pre-drying of the material. Short residence times, low thermal and mechanical stress on the melt and highly efficient degassing have characterised MRS technology for decades.

With the new MRSjump extruder, the MRS screw section has been modified and extended so that, in combination with a 1mbar vacuum unit developed for this purpose, the viscosity of the polyester can be raised or stabilised to the desired level directly in the extrusion step.

A downstream IV build-up in a solid state polycondensation (SSP) is not necessary. For the first time, the processing of materials with low or highly fluctuating input viscosities is possible in a single extrusion step.

The extremely compact design of the MRSjump extrusion line requires little space, energy and maintenance



Gneuss Flange Pressure Sensor

New size 110 for Rotary Filtration Systems, Retrofit Solutions for Demanding Applications:

Gneuss Filtration Technology is introducing an additional size across its line of Rotary Filtration Systems. The models RSFgenius, SFXmagnus, SFneos and CSFprimus are now available in a size 110, which offers

almost 20 % more active screen area than the size 90 for each model, depending on the specific model. In the past the next size up was the size 150, with a jump of more than 50 % in active filtration area. The new intermediate size will

ensure an optimized and cost efficient filtration solution for every application.

Rotary Filtration Systems operate continuous, automatic, process and pressure constant. They are characterized by a filter disk on which the screen cavities are located in a ring pattern. Screens can be changed on the part of the filter disk that is not active in the melt channel, while the production process continues to run without any interruptions or disturbances. Gneuss Melt Filtration Systems can be easily integrated into an existing process and are perfectly suited as a retrofit solution.e.g. for demanding recycling applications.

Gneuss MRSjump Extruder

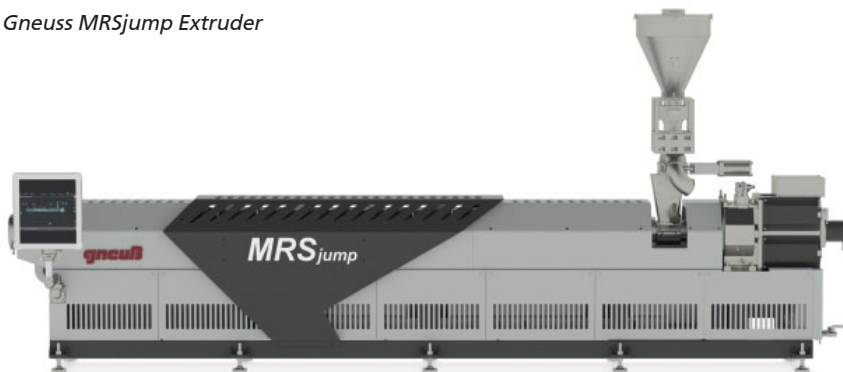



pabilities to realise even unusual sensor requirements. The lean manufacturing structure at Gneuss makes this possible with shortest delivery times. Gneuss sensors are available to match regional or application-specific requirements such as Atex, Hart Communication or EAC and are also available with digital IO-Link communication. For special process conditions or difficult places of installation, Gneuss offers individual sensor solutions; new here are the rotatable sensor shaft and a flange mounting solution.

Pressure and process constant Gneuss Rotary Filtration Systems

The various models differ in terms of e.g. drive design, encapsulation and whether they offer integrated back-flushing.

Intelligent, Digital Sensor Communication and Customised Sensor Solutions:
As a machinery manufacturer, Gneuss has the manufacturing ca-



Gneuss
Booth A6-6501

Gneuß Kunststofftechnik GmbH
www.gneuss.com

SMART EXTRUSION

The only website collecting information about smart technologies of extrusion

34 600 + average monthly visits

Geographic distribution of Smart_Extrusion readers, %

- Germany
- Austria and Switzerland
- Italy
- Eastern Europe
- Benelux countries
- Scandinavia

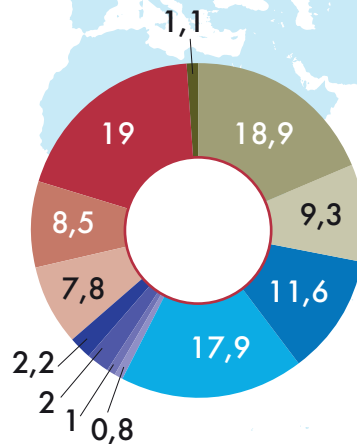

- Other
- Asia
- Russia
- South America
- North America
- Other Europe

Pump & Filtration Systems, Pelletizing & Pulverizing Systems, Recycling Systems and Digital Solutions

• MAAG ETTLINGER has unveiled a new generation of tried-and-tested ECO high performance melt filters for use in PET recycling. Their new features take into account the need for systems with a higher product throughput and are initially available in sizes suitable for medium-sized recycling lines. The new performance enhanced ECO 350 replaces the former ECO 250, while the new ECO

Strand pelletizer
PRIMO FC 200



MAAG Group PEARLO®
Underwater Pelletizer



Ettlinger's new
ECO 500 high
performance melt
filter

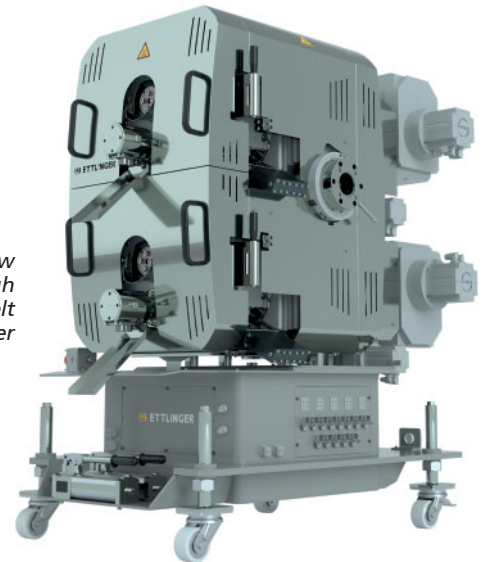

500, capable of achieving capacities of up to 4,000 kg/h, replaces the former ECO 250 Twin. The ECO 200 completes this range.

- Innovative high-performance pelletizing machines not only for the polymer industry including direct crystallization. Efficient systems for the production of biopolymers. Technology-based, optimized pellet shape up to micro pellets. Recycling systems with added value. Tools with significantly longer service life until knife change and/or die plate grinding.
- Innovation in strand pelletizing: From lab size to Compounding/Masterbatch and large scale polymerization.
- All MAAG Group extrex® gear pump in x6 class design are completely re-engineered and have redesigned components, from the shafts through to the bearings and seals, and optimized the interaction of the components. Specially developed gear teeth with low compression allow very high pressures to be achieved with low shear rates. The result is a further increase in achievable product quality, volumetric efficiency, as well as production consistency and safety.



Maag Group
A6-6202

Maag Group
www.maag.com

Focus on Circular Economy:

At the 27th Fakuma, WEIMA will present fundamental process steps on the way to efficient recycling of plastics at a joint booth with its long-standing partner Neue Herbold.

Recycling, sustainability, and the circular economy are not only a hot topic in the industry, but also among operators and the public. While on the one hand it is about guaranteeing that new products are recyclable (keyword Design for Recycling – D4R), on the other hand it is also about ensuring that recyclates can be used. This is the only way to ensure that plastics remain in the cycle for an extended period of time and that plastic waste is used as raw materials for new products in a resource-conserving manner. The topic of circular economy will also be in the foreground at the booth of the shredder specialist. After all, a functioning recycling economy can only be realized with high-quality recyclate. To meet the strict quality criteria, the best possible processing of the plastic is necessary.

WEIMA WLK 1000:

Single-shaft shredder for large-volume plastic parts, films, and fibers. At the booth, WEIMA will present the versatile WLK 1000 single-shaft shredder. It stands out for its high throughput and flexibility in daily use. The WLK 1000 shreds not only massive start-up lumps, production waste or large-volume

WEIMA WLK 1000 single-shaft shredder



Two-stage shredding solution with WEIMA shredder and Neue Herbold granulator

plastic parts made of PE, PP, PVC, PU or PET, but also tear-resistant fibers and films to a homogeneous size. The first step on the way to producing high-quality recyclate.

First-class shredding results

The shredder can be optimally adapted to any application with various equipment options. The V-rotor, with a working width of 1,000 mm and a diameter of 370 mm, delivers first-class shredding results. For flexible materials such as films, filaments, and fibers, WEIMA also offers the F-rotor for a particularly precise cut. The counter knives of the WLK 1000 are manually adjustable and reversible. This allows the appropriate cutting geometry to be optimally configured for each material stream. As a result, shredding remains energy-efficient, wear costs can be minimized, and knife service life can be significantly extended.

Flexible for varying material flows:

The speed of the rotor can be continuously adjusted via the optional frequency converter. This makes the machine particularly flexible, especially with changing material flows. The large-volume hopper with the innovative log spacer shape prevents the formation of material bridges even

when shredding particularly large parts. Direct filling takes place via the low loading edge by conveyor belt, gripper, wheel loader or manually and is therefore convenient to operate.

Two-stage processing of plastic waste:

A two-stage processing system is often required to achieve particularly fine particle sizes. In cooperation with the granulator specialist and long-standing partner, Neue Herbold, WEIMA has already implemented many joint customer solutions. Shredders from WEIMA can be precisely operated and controlled via Siemens PLC control. They have common interfaces (such as PROFIBUS or PROFINET) and can thus be optimally integrated into existing production systems. This also includes peripherals such as extraction, metal detection and secondary crushers. This optimizes the use of downstream production machines (such as washers and extruders) and increases the efficiency of the recycling line.



WEIMA
A6-6201

WEIMA Maschinenbau GmbH
www.weima.com

Extruder Manufacturer shows its Versatility:

FEDDEM is pleased to be able to provide an overview of its LFT pultrusion lines for the production of long glass fibre pellets as well as on the subject of upcycling and service in addition to its FED 43 MTS extruder at Fakuma 2021.

The company will be presenting a twin-screw extruder of the type FED 43 MTS 32 L/D. With a screw diameter of 43 mm and up to 142 kW drive power, this extruder size is ideal for pilot and production applications of small to medium batch sizes.

The FED 43 MTS model range offers all the typical FEDDEM advantages that are of great benefit in compounding and masterbatch applications:

- Highly efficient melting and mixing of product components through the use of FME mixing elements. Kneading-block-free screw geometries prove their worth in a wide range of applications.

Picture 1: FED 26 MTS extruder with 3 gravimetrically metered material streams and metal separator in the main stream



Picture 2: FEDDEM is pleased to finally be able to inform its customers about innovations and further developments on site at Fakuma

- Modular, thermally insulated protective covers of the processing section as protection against contact and for a more favourable energy balance of the process.
 - Process length can be individually adapted by extension unit
 - FSB side feed(s), FSV side vacuum deaeration, FSE side vent(s) each with quick connections (mechanical, electrical and, if applicable, for cooling water connections).
 - FSK strand head, compact and equipped with swivel hinge. On request, also available with patented arched nozzle for special applications.
 - Robust design of all system components for continuous operation.
- "The technology of LFT pultrusion lines for the production of LFT-G long

pellets has been around for several years. FEDDEM has taken a fresh look at the details of the line components to improve performance, quality and handling. The result is not only unprecedentedly tight tolerances from the fibre content in the pellets, but also the repeatability of the achievable material properties of the LFT compound on different lines and line sizes with haul-off speeds of up to 60 m/min," says Klaus Hojer, Business Development Manager at FEDDEM GmbH & Co. KG.

This was made possible, among other things, with a patented, modular impregnation tool. The extruder for melt preparation is installed parallel to the roving line, which allows considerable savings in the space required by the plant. All maintenance

access points for the individual plant components have been designed to allow direct and fast access to ensure the highest possible plant availability.

Upcycling:

In order to keep as much plastic as possible in production in the course of global efforts, compact plants for the processing of production waste are becoming increasingly interesting. In upcycling applications, twin-screw extruders are proving their worth in terms of high mixing performance in a gentle process that delivers high-quality recyclate. Additives can be incorporated into the process that, for example, adjust the viscosity and

colour of the recyclate for optimal reuse.

At the same time, the space requirement can usually be reduced to a minimum, which can be a great advantage when setting up in the production environment (see Picture 1).

"Screw geometries for FEDDEM extruders in these applications are equipped with FME mixing elements for gentle processing. The processing section can be equipped with a variety of wear protection types, depending on the application," says Hojer.

To overcome investment hurdles, the company also arranges attractive leasing solutions for smaller systems.

Service:

In addition to its plant technology, FEDDEM also offers a wide range of services. From measuring process parts to assessing the overall condition of a plant with recommendations for maintenance measures.

"In the meantime, augmented reality (AR) has found its way into everyday service - even to the point of remote commissioning of a plant on another continent," Klaus Hojer reports.



FEDDEM
A6-6217

FEDDEM GmbH & Co. KG
www.feddem.com

Sustainability Geared Colour and Functional Masterbatch Solutions

At Fakuma 2021 in Friedrichshafen, Tosaf /Afula, Israel, and its German subsidiary Tosaf Color Service, Karlstein, will highlight sustainability geared solutions in their wide range of functional, colour and combi-masterbatches for extrusion and injection moulding. These will include colour masterbatches for recyclates with a special focus on post-consumer plastics as well as biodegradable masterbatches. Another focus will be on e-mobility and electronics applications. Here, RAL 2003 Orange and a wide range of UL-listed colours make Tosaf a globally leading producer of masterbatches for the electronics and automotive industries. A third key issue will be light diffuser solutions for polymethyl methacrylate (PMMA) and polycarbonate (PC), including coloured grades.

New at Tosaf are orange colour masterbatches for PA, PP and PBT in e-mobility applications (© Vladimka production/shutterstock)

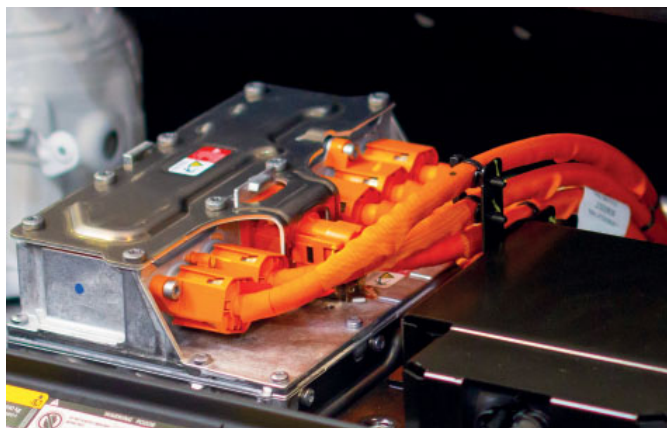

These fully harmonise the appearance of covers for light sources with the colour of the surrounding frame or car body colour, making them virtually invisible until illuminated.

Consistent colouring of recyclates

Due to source-related inconsistencies, recyclates from post-consumer scrap can show significant differences in their basic colour. Tosaf has developed highly efficient masterbatches, specially tailored to cover such variations in a way that the final products meet the customers' specifications within tight tolerances.

Supporting biodegradability

Biodegradable polymers can provide sustainable alternatives to conventional grades, and this is particularly true for agricultural films. Typically, such films are manufactured with additives to provide specific functionalities ranging from UV stability to antifog and IR filtering effects. Tosaf has developed appropriate additive masterbatches based on biodegradable carriers such as polylactic acid (PLA) and resin (rosin).



Tosaf
B4-4402

Tosaf Compounds Ltd.
www.tosaf.com

Spotlight on High Quality Output and Reliability, New PET Hot-Wasch System and Micromat Premium Shredder

Besides digitalisation and automation, the circular economy is a key topic in the plastics processing industry. Changing from a linear to a circular economy, the quality of the recycled material plays an increasingly important role. Lindner, one of the leading manufacturers of shredders, system solutions and industrial washing systems for plastics recycling, is taking on this challenge and will be presenting a new hot-wash system for recovering PET (polyethylene terephthalate) at Fakuma 2021. Equipped with the new hot-wash tower and the also new Lindner step dryer, the company is setting new standards in PET recycling. When shredding the plastic to be recovered, the focus of Lindner's Micromat series is firmly on quality, reliability, robustness and experience.

The circular economy remains a hot topic. Sustainability, resource conservation and the reduction of the ecological footprint take centre stage and underline the necessity of recycling all kinds of plastics. In addition to efficiency and cost-effectiveness, the main challenge is to use a reliably functioning system that allows for a high degree of flake purity

The Micromat series – robust, reliable, easy to maintain. The hydraulic maintenance door provides easy and quick access to the rotor for rapid removal of non-shreddables with little material leakage and an easy exchange of knives and knife holders



and therefore high-quality recycle.

The Micromat, Lindner Recyclingtech's original powerhouse, shreds waste materials reliably and efficiently. The signature feature of the Micromat series is its Mono Fix rotor, which guarantees universal applicability by enabling different or mixed rotor configurations. Various pointed or flat knives and special counter knives

can be fitted to one and the same rotor as required depending on the input material. As a result, this Mono Fix technology ensures a high and consistent throughput with a wide range of materials that are often classified as difficult.

The latest product from Lindner's subsidiary Washtech is the hot-wash system with the PET hot-wash tower and Lindner's step dryer, which were developed specifically for the PET sector. The innovative stainless steel step dryer dries the material particularly gently by slowly adjusting the rotation speed in five steps. This results in less friction and a lower fines content. The compact step dryer delivers throughputs of 1,000 to 3,000 kg/h at a drive power of 30 kW.

Thanks to the new hot-wash, the last remaining contaminants such as adhesives, labels and prints are completely removed from PET bottles. The PET hot-wash tower can be operated with or without caustic solution and works with a separate water circuit.



Lindner's new PET hot-wash tower for high-quality PET recycling (Copyright: Linder Recyclingtech)

Gentle cleaning and defined dwell times guarantee high-quality output materials, which are the perfect basis for producing food grade rPET.

„The first PET line with the new components has already been sold in German-speaking countries, and commissioning will take place this autumn,” says a delighted Harald Hoffmann, Managing Director at Lindner Washtech. Lindner Washtech supplies the turnkey line including NIR sorting, label remover and water treatment. „With our new washing components, we also want to set new standards in the PET sector and make an important contribution to a functioning circular economy,” Hoffmann emphasises.



Lindner
A6-6108

Lindner
www.lindner.com

EXTRUSION

EXPERT MAGAZINE ON PLASTICS EXTRUSION

The only technical magazine worldwide exclusively for the sectors:

- Material Preparation
- Compounding
- Extrusion
- Recycling
- Calendering
- Thermoforming
- Welding
- Finishing of Plastics and Elastomers



Extrusion (German)

Extrusion International (English)

Extrusion International USA (English)

Extrusion Russia Edition (Russian)

Extrusion Asia Edition (Mandarin/English)

The only plastics trade magazine for Asia, published from Germany

8 issues a year

6 issues a year

6 issues a year

4 issues a year

2 issues a year

**SMART
EXTRUSION**

All editions available for free:
www.smart-extrusion.com

VVA Verlag GmbH Cologne/Germany



Digital Control Now Available for Entire Granulator Range:



Premiered at K 2019, the digital Smart Control System is now available for Hellweg's entire range of granulators (© Hellweg Maschinenbau)

Fakuma 2021 in Friedrichshafen will be Hellweg's opportunity to highlight that its entire range of granulators is now equipped with the digital Smart Control System, which was premiered at K 2019. Monitoring is now an option for all sizes, starting from the 150 series machine-side granulators for small parts and sprues right up to the heavy-duty 600 series designed for the toughest applications. The control system detects not only parameters such as power consumption, motor speed and bearing temperatures but also the state of blades, screens and V belts. The recent implementation of the Ethernet-based, cross-system OPC UA standard means the machines can now be integrated into control center systems.

In addition to providing component monitoring and interconnection with other machines, the control system also has a 'boost' mode for adapting grinding capacity to production-related fluctuations. Adaption of operating parameters to defined plastics means that even temperature-sensitive grades can be straightforwardly processed without water cooling. The 'eco' operating mode adjusts machine speed to the prevailing input volume, so reducing power consumption.

As Managing Director Mark Hellweg explains, "The success of the two past years shows that Smart Control is meeting a long-felt need in the sector. Our customers

particularly appreciate the ability to monitor the mills' mechanical components and schedule maintenance accordingly, so avoiding disruptive and costly production downtime. High levels of demand have meant we have been able to adapt the Smart Control System to all our series much sooner than originally planned."

And Hellweg adds, "2020 was a difficult year, but thanks to Smart Control our order books have been and remain full. In fact, last year's turnover was only just short of our previous record in 2019. Another helpful factor was that our new, approx. 500 m² production shop became ready for occupation, so significantly expanding our capacity. And because development and administrative workload is rising hand in hand with production, we are just finalizing plans to triple our office space. Construction of a new, two-story administration building is scheduled to begin this year."



Hellweg
A1-1005

Hellweg Maschinenbau GmbH & Co. KG
www.hellweg-maschinenbau.de

SMART EXTRUSION

**THE SPECIALIZED WEBPORTAL
ON EXTRUSION
FOR EVERY MODERN NEED**



VM Verlag GmbH
Cologne, Germany

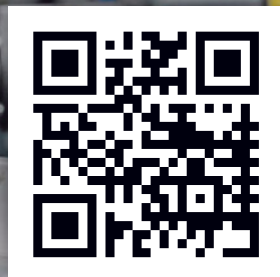

www.smart-extrusion.com



The companies of the Feddersen Group are looking forward to making personal contacts at the fair again this year, as they did last time in 2018

Shaping a Sustainable Future

After one year without trade fairs, the companies of the Feddersen Group are finally looking forward to meeting their business partners in person again at Fakuma 2021. They will be coming up with a whole bouquet of new products and services to provide ideas and inspiration for new, future-oriented and sustainable applications.

The following companies of the Feddersen Group will be exhibiting together: K.D. Feddersen GmbH & Co. KG, K.D. Feddersen Ueberseegesellschaft mbH, AKRO-PLASTIC GmbH, AF-COLOR, branch of AKRO-PLASTIC GmbH, BIO-FED, Branch of AKRO-PLASTIC GmbH, PolyComp GmbH and M.TEC ENGINEERING GmbH

Plastics distributor K.D. Feddersen GmbH & Co. KG sealed a cooperation with Ascend Performance

Materials, the world's largest fully integrated manufacturer of polyamide 6.6, at the beginning of

2021. The Ascend product families include unreinforced, reinforced, impact-modified and flame-retardant engineering plastics as well as other special formulations for extrusion and injection moulding. Since March 2021, the company has also expanded its portfolio in Germany and Europe to include the Hostaform® (POM), Vectra® (LCP), Celanex® (PBT) and Fortron® (PPS) medical grade range from Celanese.

The Feddersen Group's cooperation with the Korean company Hyosung Chemical was also intensified in Europe. Since spring, K.D. Feddersen GmbH & Co. KG and its regional subsidiaries distribute all

polyketone grades belonging to the Hyosung brand POKETONE™ in Germany and Europe, after the sister company K.D. Feddersen Ueberseegesellschaft mbH with its Polymers & Compounding Technology business unit has been selling mainly its extrusion grades to the compounding industry since 2015. Thermal management will become increasingly important in future developments of alternative drive concepts. To ensure all this, suppliers to the automotive industry must use application-optimised materials, such as Hostacom EKG 2087T from Lyondellbasell. This grade is a polypropylene (PP) copolymer reinforced with 30 % short glass fibres. The PP compound shows superior performance in terms of creep resistance compared to standard grades.

Notably, the distributor has also expanded its range of materials from alternative, sustainable sources, accessing many new, special products from its partners Celanese, TRINSEO, AURORA Kunststoffe GmbH and BIO-FED, Branch of AKRO-PLASTIC GmbH and member of the Feddersen Group. The thus expanded portfolio includes additional biobased and biodegradable plastics as well as high-quality recycled materials from post-industrial as well as mass-balanced sources with a property and quality level that is close to or even equal to that of virgin materials. In terms of the circular economy, the new alternatives offer potential solutions for reducing the carbon footprint.

Cologne-based BIO-FED will also be exhibiting on the group's joint stand and focuses on its biocompound product range, which is suitable for flexible and solid applications as well as for a wide range of manufacturing processes.

BIO-FED offers transparent and filled biocompounds for thermoforming and profile extrusion. Certification according to OK compost INDUSTRIAL is currently in preparation.

Materials are also available for blow moulding applications and for monofilaments.

For film extrusion, the company offers biocompounds with OK compost HOME certification, for example for fruit and vegetable bags. Special soil-degradable grades for mulch films are also available. The corresponding SOIL certification according to EN 17033 by DIN CERTCO is also currently in preparation. A steady expansion of the portfolio with further biobased and biodegradable products in the sense of the circular economy and the Green Deal is in the works.

Together with AF-COLOR, also a branch of AKRO-PLASTIC GmbH, the company works on color and additive concentrates for numerous problem solutions in the field of recycling management. The products resulting from the cooperation make a significant contribution here.

The soot-free masterbatches of the AF-Color® IR product range contribute to improved NIR detection of different kinds of plastics in the field of waste sorting.

Likewise, the in-house research and development department of AF-COLOR and BIO-FED products is working on an odour absorber on the basis of biobased, biodegradable and environmentally compatible additives for example. These special additive masterbatches will be available as AF-Eco® after certification within EN 13432, or otherwise distributed as part of the AF-Complex® portfolio.

Furthermore, within the AF-Color®-HP product range for high-temperature polymers, AF-COLOR offers you new color shades for the coloring of polyamide, such as a bright orange for e-mobility applications. A newly developed PA-compatible blowing agent product range enables a variety of different applications in the field of lightweight construction.

Sustainability is a high priority at AKRO-PLASTIC. CO₂-neutral electricity and gas have already been

used for production and the administration buildings since 2019. At Fakuma 2021, the new sustainable product ranges AKROMID® NEXT and PRECITE® NEXT will be presented for the first time.

One representative of the future-oriented AKROMID® NEXT portfolio is the partially bio-based AKROMID® NEXT G based on PA 6.9. As a density-reduced "LITE" compound, with a proportion of bio-circular PP and processed carbon fibres, sustainability is raised to a new level. By combining it with chemical or physical foaming processes, the idea of lightweight construction can be taken even further. The combination of sustainability, low density and hydrolysis resistance predestines the material for the cooling water circuits of future electric vehicles, for example.

In addition, AKRO-PLASTIC and its subsidiaries BIO-FED and AF-COLOR will have various sustainable products certified according to the leading sustainability certification systems ISCC PLUS or REDcert2.

The Aachen-based engineering company M.TEC ENGINEERING GmbH, which is also part of the company group, is expanding the AI-based development method for warpage optimisation of plastic components into a group of simulation-based development tools. This allows topics such as sustainability, economic efficiency and innovation to be integrated into the engineering of products and processes. How exactly this works will be explained to the interested trade fair audience on site.



Feddersen-Gruppe
B2-2209

Feddersen-Gruppe
holding.kdfeddersen.com

UHMWPE for Injection Moulding, Extrusion and 3D Printing:

At Fakuma, plastics distributor DREYPLAS will showcase innovative application possibilities for the ultra-high-molecular-weight polyethylene (UHMWPE) LUBMER™ from Mitsui Chemicals. Compared with conventional sintered semi-finished products, this offers possibilities for considerable cost savings in the production of moulded parts and profiles that also boast excellent surface slip properties. This advantage comes from the thermoplastic processability by injection moulding and extrusion. In this way, it is no problem with Lubmer to produce parts with narrow tolerances and very low depths of roughness. As a result, the amount of time required is significantly reduced, and the large quantities of costly, non-reusable production scrap from the machining of semi-finished products are no longer produced. In current sampling trials at customers, Lubmer has also proved that the product is suitable for 3D printing.

The difference between the various UHMWPE types lies in the length of the molecule chains. With conventional types, they are so long that they cannot be melted but have to be sintered into the semi-finished products. Compared with that, the molecular weight of the Lubmer types supplied in granule form is reduced by just enough for processing to be possible on conventional injection moulding machines and extruders. As a result, it provides greater

UHMWPE types in the DREYPLAS portfolio that are suitable for injection moulding, extrusion and 3D printing allow considerable cost savings compared with the machining of semi-finished products (© Dreyplas)



design freedom than with the machining of semi-finished products and, furthermore, the production scrap – which is less anyway – can be melted again and returned to the process in an environmentally friendly manner.

Despite the reduced molecular weight, Lubmer offers, with smooth friction partners such as steel, equally good tribological properties as components made of a sintered semi-finished product. This and its recyclability in the polyolefin stream make it in many applications a sustainable alternative to engineering plastics such as PPS, POM, PA or PBT. Lubmer can be used in applications at long-term temperatures down to –200°C, and its chemical resistance, heat resistance and (low-temperature) impact strength are the same as those of UHMWPE semi-finished products. It complies with all the REACH regulations and is approved to FDA and EU10/2011 for food-contact applications.

Alongside the basic types, namely Lubmer L3000 with the highest flowability, L4000, and L5000, which is also suitable for extrusion and has the highest abrasion resistance, DREYPLAS also markets the higher temperature-resistant Alloy LS4140, which, thanks to its polyamide modification, combines elevated temperature resistance with good flow properties. Lubmer can be used both with hot runner systems and with traditional tunnel gates. The light and opaque intrinsic colour facilitates the use of colour masterbatches. Other functional additives can also be incorporated via the conventional metering systems. Lubmer offers very good sound insulation and better electrical insulation properties than most other polyolefins. The combination of low sliding friction and high abrasion resistance also make it an effective alternative for applications such as bearings that are subjected to high stresses, and generally also for technical components that are subjected to sliding friction during use. At the same time, extruded guide elements and profiles also offer the typical benefits of UHMWPE.



DREYPLAS
B1-1004

DREYPLAS GmbH
www.dreyplas.com

New Halogen-Free Flame-Retardant Polyamide:

Asahi Kasei is introducing the halogen and red-phosphorous free flame retardant Polyamide 66 LEONA™ SN to the European market. This semi-aromatic material combines high levels of safety, surface quality and laser printability.

Tightening safety and environmental regulations in the European Union are increasing the demands placed on materials used for electrical appliances and systems. Halogen- and red phosphorous free solutions are the key to ensure the safety of a wide range of applications while at the same time taking a more sustainable approach compared to conventional materials.

The Japanese technology company Asahi Kasei is currently introducing the halogen- and red phosphorous free, semi-aromatic polyamide 66 LEONA™ SN to the European market. The LEONA™ SN grades are certified with the V-0 flame retardancy at wall thicknesses of 0.75mm according to the UL standard, and achieve 600V, the highest value on the Comparative Tracking Index (CTI).

In addition to the flame-retardant and creep-resistant properties, the material features a superior surface quality. This is achieved without additional treatment and coating and even with a glass-fiber content of up to 50%. Another characteristic of this material is its high retention rate of physical properties in a conditioned state. While comparable halogen-free PA66 materials show a significant decline in properties, LEONA™ SN maintains a high level of tensile strength and flexural modulus also after moisture absorption. This opens up new possibilities for applications in environments, where the use of standard FR PA66 can become an issue.



LEONA™ SN offers good laser transparency and laser printability

Furthermore, LEONA™ SN provides an excellent laser printability and allows for a clearer surface marking than general materials with red phosphorus in high speed machining of 1000 mm/sec, contributing to an increased speed in production.

"LEONA™ SN fulfils the strictest requirements in regard to safety, surface quality and laser printability while at the same time being fully in line with the environmental regulations. The high level of key properties will make this material a problem solver for our customers and open up new possibilities in a broad range of applications", says Taku Ishida, General Manager of the Engineering Plastics Division at Asahi Kasei Europe.

The LEONA™ SN series is part of Asahi Kasei's new LEONA™ polyamide resin family. This series also comprises UV resistant grades (SU series), and semi-aromatic grades (SG series) for metal replacement and applica-

tions in the automotive interior. They all have in common the unparalleled combination of excellent surface quality, easy processability and high mechanical performance.

Asahi Kasei has a broad portfolio in the field of halogen-free and flame retardant polymers, including the modified polyphenylene ether (mPPE) XYRON™ and the polyamide 6.6 LEONA™. Leveraging its expertise in this area even further, the company has developed the mPPE-based particle beads foam SunForce™, the first foam of its kind certified with an UL94 V-0 flame retardance.



Asahi Kasei
B5-5319

Asahi Kasei Europe
<https://asahikasei.group/eu/leona-sn/>

“The future is sustainable”:



The international chemical distributor Nordmann will present itself at the upcoming Fakuma together with its partners and co-exhibitors Marfran (formerly FFE), Völpker, PMC, UBE and Repol. Sustainable circular economy – this is one of the top topics of this year's Fakuma.

Recycling is an important topic that is being given higher priority in the plastic industry, driven by the social discussion regarding climate protection. In the last few years, Nordmann has aligned its product portfolios more heavily with this. “For example, in Circular+ from our partner Kraton Polymers and the CEVO® products from VOELPKER Spezialprodukte, we are offering the first additives specially developed for this application area. The specifications of the politicians and the ever-increasing interest of industry show that we are at the beginning of an extremely exciting and sustainable development,” comments Christian Schur, Business Manager Polymer Additives at Nordmann.

“After the collapse due to the coronavirus, the plastic markets are recovering rapidly. A recovery that is characterised by high volatility and shortened planning horizons. At the same time, a sustainability transformation is taking place, as evident, for instance, in the use of recyclates or in the development of plastic products for the requirements of electromobility. Here, opportunities and challenges are closely packed together,” explains Dietrich Albrecht, team leader at UBE Europe.

In the field of compounding, Nordmann partner UBE offers solutions for thermal and charge management in electromobility in the common temperature ranges. UBE is also very well positioned in the market for high-pressure hydrogen tanks.

The appearance at the trade fair in Friedrichshafen underlines the focus of joint actions. “The current raw material scarcity has shown how carefully we must handle resources and how important good communication and joint actions are. Here, developed partnerships with suppliers from Europe, North America and Asia have many advantages, especially in the current market environment,” explains Frederik Röhrs, Sales Director Plastics & Elastomers at Nordmann.

Since 1 September 2021, Frederik Röhrs has been responsible for a newly created industrial unit at Nordmann, which includes the plastics and elastomers industries. With this step, Nordmann is consolidating related materials and industries with a high automotive content and common customer structures.

“We are pleased – provided the pandemic events allow it – to meet the representatives of the plastics industry on site at this year's Fakuma and to discuss market developments and new, custom-fit solutions with differentiated products and services with our customers,” says Nico Vossers, Business Manager Thermoplastics at Nordmann.

VOELPKER is also focusing on the intensive dialogue on site: “At the trade fair, we would like to present – in addition to many other products – our wax additives of the ‘Plastic Series’, for example, which due to their unique properties are used as multi-functional high-performance additives in the plastic industry, often also in recycling,” adds Dr Lutz Matthies, Head of Business Development at VOELPKER.



Nordmann
B5-5214

Nordmann, Rassmann GmbH
www.nordmann.global



Web conference

December 8, 2021 • Start: 10.00 CET

lab.extrusion-info.com

The official language
of the conference is English

Laboratory & quality control in plastics processing

Developed by:

VM VERLAG
Cologne/Germany

EXTRUSION

Our sponsors:



- laboratory equipment
- quality control of input raw materials
- quality control of finished products
- analytical equipment
- measuring equipment
- pilot and test lines
- desktop mini IMM and mini extruders
- laboratory mixers and compounders
- laboratory and processing simulation software
- metrology and equipment verification
- laboratory analysis services
- formulation development services
- certification services
- external engineering and research services
- R&D in the enterprise



Contact: Alla Kravets • Tel.: +49 2233 949 87 93 • a.kravets@vm-verlag.com



THINK OUTSIDE THE BOX



Approaching problems in new and innovative ways; conceptualizing problems differently; and understanding a position in relation to any particular situation in a way never thought before are the basis of the companies that want to stay relevant and inventive. Starting from our customer's experience and working backwards to technology, Tecnomatic partners all the pipes companies, which are aiming at development and leadership, cultivating the ability to look at things differently from the common thinking.

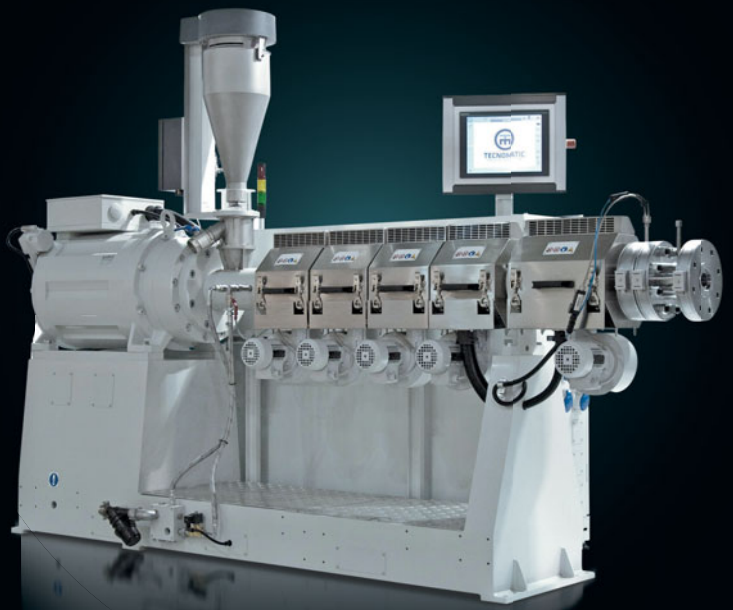

TECNOMATIC

TECHNOLOGIES FOR PLASTIC PIPES PROCESSING

Tecnomatic Srl | Bergamo | Italy | tel. +39 035 310375 | tecnomaticsr.com