

06/2020

VVA VERLAG
Cologne /Germany

EXTRUSION INTERNATIONAL



**Partnership knows
no limits.**

Clear solutions are our passion.

BREYER

extrusion lines

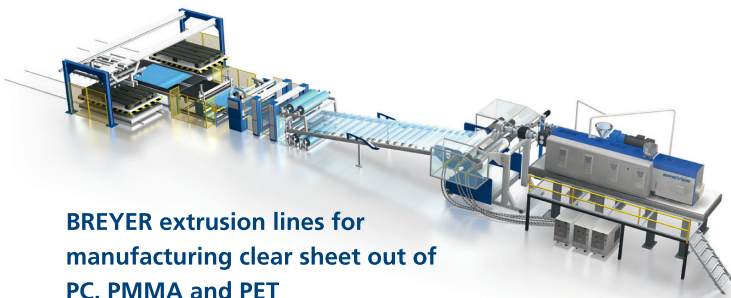

BREYER extrusion lines for
manufacturing clear sheet out of
PC, PMMA and PET

With BREYER's extrusion lines you can safely produce crystal-clear film and sheets of high quality. With more than 70 years of experience in manufacturing extrusion systems for highly transparent film and sheet, you are always on the safe side with BREYER. Benefit from our experience.

BREYER GmbH Maschinenfabrik · Georg-Fischer-Str. 40 · D-78224 Singen · Germany

Quality made in Germany · www.breyer-extr.com



Profile guillotine PTT-200

INNOVATION



- Especially for complex as well massive profiles.
- Basic construction consists a frame in solid Aluminum construction in which the controls are integrated.
- Through large sliding windows fast and comfortable access to the cutting unit.

Particularities:

- For this special version of the cutting knife head the cutting knife can be set in any position. This allows the slope of the knife to the respective profile geometry optimally adapted become.
- A new clamping system, which fix the knife at 4 points. It allows more pulling force on the blade to cut more massive profiles.
- The new clamping system result in a much higher angular accuracy of the cut.

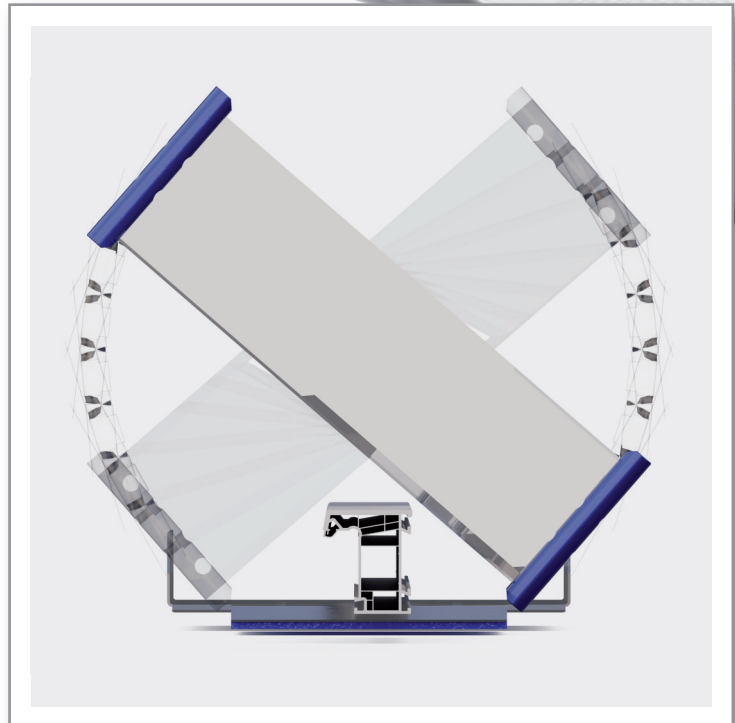

Made in
Germany

PCL Profile separating machine



When profiles are extruded, start-up profiles occur again and again. They are representing a high material value. It is very labour intensive to recycle this profiles.

With the PCL profile separating machine from Stein Maschinenbau, this process is greatly facilitated and accelerated many times over.

Thanks to its quickly exchangeable cutting units, as well as the two powerful caterpillars, the PCL can cope with any profile and allows you to recycle your profiles in the best possible way. By non-cutting separators, the profile is split into individual Material fractions which are optimally recyclable. Smaller sections are sorted and granulated directly in the machine.

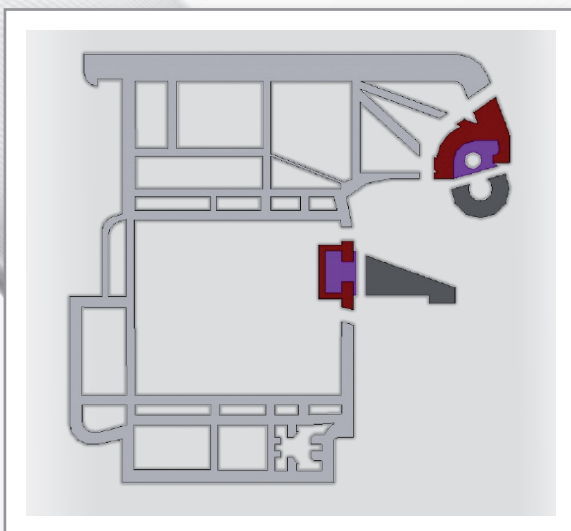

Your advantages

- + High throughput
- + Short changeover times
- + Highest possible Recycling degree
- + Unmixed material separation



**STEIN Maschinenbau
GmbH & Co.KG**

Wartbachstr. 9
D-66999 Hinterweidenthal/Germany
Tel. +49/63 96/92 15-0
Fax +49/63 96/92 15-25
stein@stein-maschinenbau.de
www.stein-maschinenbau.de

**The PCL from Stein Maschinenbau
separates YOUR profiles!**

Firms in this issue	6	Blown Film Extrusion	
Imprint	7	Vietnam – Setting New Standards for Standard Blown Film Machines	28
Industry News	8	Blown Film	
Calendar	8	Environmentally Friendly Deep-Drawing Films – Thin and Mono-Material	31
No Trade Fair Appearances in 2021	8	Sheet Extrusion, Recycling	
CHINAPLAS 2021: Plastics Industry Responds Impressively to the Pandemic	9	ABS and PS Sheet for Technical Components – Melt Filtration as the Key to Increased Efficiency and Recycled Content	32
POWTECH WORLD – Online Content and Successful Restart in China	10	Processing – Interview	
Interpack 2021 Still on Course to Take Place – New General Conditions for Exhibitors	10	„We are here for our customers, even in challenging times.“	34
Fakuma 2021 – Industry and Technology Barometer in Preparation	11	Extrusion Technologies	
PLASTPOL 2020	12	New Extrusion Equipment Standards	35
Interplastica 2021 in Moscow Cancelled	12	Pipe Extrusion – Case Study	
New Agent for Brazil, Paraguay and Bolivia	13	Ideal for Large-Diameter Pipes – Less Sagging, Better Quality	36
Course Charted for K 2022	14	Pipe Extrusion	
Acquisition	14	Concentrated Technology for Multiple Applications – Renewed Line of E-GO Single Screw Extruders for PO Pipes presented	38
Donation Helps Clean Plastics Anniversary	15	Extrusion Technologies	
iCorona – the Beating Heart of Surface Treatment	16	Powerful and Highly Efficient – Successful Market Lunch of the Four Large ZE BluePower Compounding Extruders	39
Sales Agent in France	17	Size Reduction Technology – Interview	
Used Machinery Trade	18	„Digitisation Creates High Transparency“	40
Bioplastics Meet all EU Safety Standards	18	Cutting and Winding Technology	
Washing Line in the UK	19	From Pioneer to World Market Leader	42
Certification	20	Quality Control	
New Location in Singapore	20	Clever Use of Defects – Integrated Quality and Production Monitoring	44
New Head of Global IT Appointed	21	Materials	
Certification as Recyclable Material in Europe Earned	21	Survival Recipe for the Market of Polymer Products – „The Best Apples from the Best Apple Trees“	46
European Recycling Product Manager Appointed	22	Extrusion Technology, Remote Maintenance	
New Website	22	Oculavis SHARE – Remote Maintenance with Augmented Reality	48
New Market and Technology Report: Chemical Recycling	23	Material Handling	
„The Bullet™“ Extrusion Head	23	New Pump Series and Retrofit Kits for Frequent Product Changes	49
„Cable business – 2020“	24	IPTF 2020	
Recycling – Collaboration	24	International Polymer Technology Forum Successfully Finished	50
Large Die Cart with Crosshead Introduced	25		
New HDPE Recycling Plant in Mexico	25		
Sheet and Film Extrusion			
Successful Extrusion of Clear Sheet Needs a Multi Tool	26		

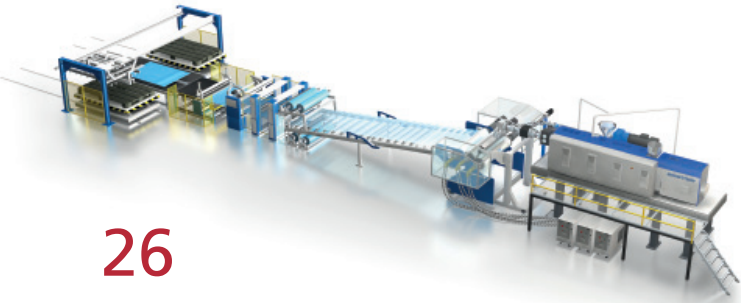

26

It's been over 60 years that BREYER built its first extruder. Since then, hundreds of sheet line systems have been exported all over the world. Most important to the success of BREYER Extrusion Lines was a close collaboration of machine manufacturers, raw-material suppliers and sheet manufacturers



39

The sales launch of the four large ZE BluePower compounding extruders with a throughput capacity of 2,500 kg/h and more started immediately after the K 2019 exhibition. The unique combination of high throughput rates and short set-up times has been well received among numerous large national and international compounding companies



44

For more than two decades now, the intensive partnership between Mondi and OCS has been cultivated for the benefit of both parties. OCS and the global Mondi Group have concluded a cooperation agreement and work on further developments has been ongoing in a continuous exchange at the management level

MAAG Group is launching the new FQ series/kit for the existing pump portfolio. Another revolutionary and innovative pump version in the industrial product portfolio, the 'FQ' keeps up with the new-age fast paced production processes, lifting the capabilities of the external gear pumps to ease the extreme needs of the customer and the industry

49

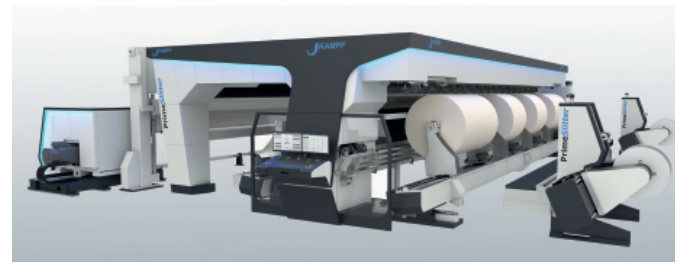
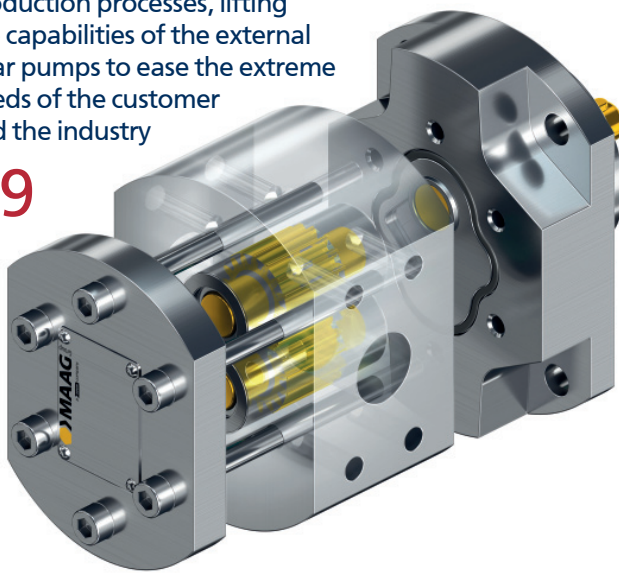

42

Since 100 years the name KAMPF has been known for innovative slitting and winding technology. For customers all over the world machines "Made by KAMPF" mean reliability, quality and productivity. The company is very proud of this

The Vietnamese plastic sector has grown significantly in the past 5 years thanks to many unique advantages that the country has. Since 2016, Polystar has already been working with 42 producers in Vietnam and has installed 187 sets of blown film extruders for various applications

28



Index of Advertisers, companies and *fairs* referred in this issue

Adsale	9, Outside Back Cover	Liansu	21
Aleko	46, 47	Lindner-Recyclingtech	20
ALPLA	14, 25	Maag	49
battenfeld-cincinnati	13, 36	Messe Düsseldorf	10, 12, 14
Bausano	38	Milliken & Company	20
Breyer	Outside Cover, 26	Mondi	44
Brückner	16	motan-colortronic	13
Bunting	22	nova-Institut	23
Chemical Recycling Europe	24	NürnbergMesse	10
CHINAPLAS	9, Outside Back Cover	OCS	22, 44
Davis-Standard	17	PlasMec	11
Earth 5R	15	PLASTIMAGEN	Inside Back Cover
Econ	34	PLASTPOL	12
European Bioplastics	18	POLYPLASTIC	24
Fakuma	11	POLYSTAR	28
Feddem	48	POWTECH WORLD	10
Getecha	40	Recycling Technologies	24
GINDUMAC	18	RiverRecycle	15
Gneuss	32	Schall, P.E.	11
Guill	17, 23, 25	SIFEM	17
Herbold Meckesheim	19	Smart-Extrusion	37
Huhtamäki Oyi	15	Stein Maschinenbau	Inside Front Cover+3
interpack	10	Targi Kielce	12
interplastica	12	TECHFINE	13
IPTF	50	TOPAS	21
Jwell	7	UNTIL	15
K 2022	14	Vetaphone	8, 16
Kampf	42	VTT	15
Kautex	21	Weber, Hans	19, 35
KraussMaffei	39	Zumbach	15
Kuhne	31		

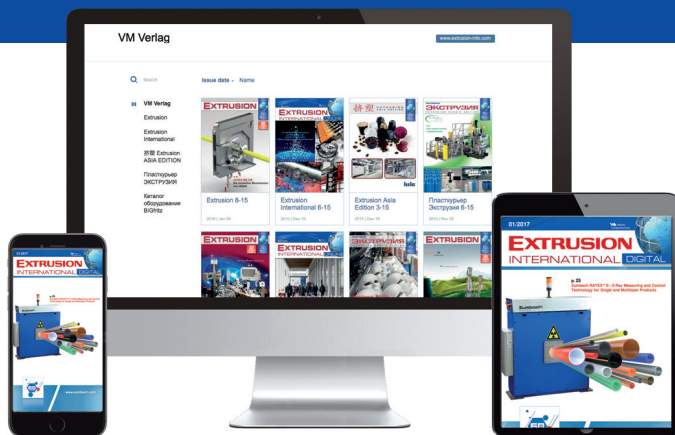

Follow the news
in the world
of extrusion!

Subscribe to digital magazines
and Smart Extrusion weekly newsletter

- **Just** submit your **e-mail address**.
- Digital magazines and news updates **free of charge**
- No spam. Your data is safe



www.extrusion-info.com/subscription

06/2020

VM VERLAG
Cologne / Germany

EXTRUSION INTERNATIONAL



The Extrusion International Magazine is published bimonthly by VM Verlag GmbH. P.O.Box 501812, D- 50879 Cologne, Germany

EDITORS

Bettina Jopp-Witt (Editor-in-chief)
Tel. +49 221 546 1539
redaktion@vm-verlag.com

Dmitry Kosuch
Tel. +7 996 730 0113
d.kosuch@vm-verlag.com

ADVERTISING SALES

Martina Lerner
Tel.+49 6226 971515
lerner-media@t-online.de

Bella Eidlin
Tel. +49 152 29907895
b.eidlin@vm-verlag.com

Olga Kirchner
Tel. +49 152 05626122
o.kirchner@vm-verlag.com

ADMINISTRATION

Alla Kravets
Tel. +49 2233 949 8793
a.kravets@vm-verlag.com

PRINTING

maincontor GmbH
Dr.-Gammert-Str. 13a, 63906 Erlenbach, Germany
T.: +49 937294810811
www.maincontor.de, info@frankhohmann.com

SALES REPRESENTATIVES

Quaini Pubblicita (Milano IT)
Tel. +39 02 39216180
info@quaini-pubblicita.it

China & Asia
octavia@ringier.com.hk, Tel. +852-9648-2561
maggieliu@ringiertrade.com, Tel. +86-13602785446

Tokyo PR Inc. (Japan)
Tel. +81 (3) 3273-2731
extrusion@tokyopr.co.jp

Reprints, Translation etc

No part of this publication may be reproduced, stored in a retrieval system, or transmitted, in any form or by any means, electronic, mechanical, photographic, recording or otherwise, without prior permission of the publisher.



www.smart-extrusion.com



JWELL



JWELL MACHINERY CO.,LTD.

+86-512-53111818 53377158 53377171 53730369
+86-519-87836658 87169158 87108958 87878918
+86-21-69591097 69591818 69591111 69593311

sales@jwell.cn
www.jwell.cn





Future of Polyolefins "Designing for Recyclability"

20. - 21. 01. 2021

Düsseldorf, Germany
www.wplgroup.com/aci/event/polyolefins-conference/

POWTECH India 2020

11. - 12. 02. 2021

Mumbai, India
Powtech-india.com

12th European Thermoforming Conference

03. - 05. 03. 2021

Genf, Switzerland
www.thermoforming-europe.org

Plastimagen

09. - 11. 03. 2021

Mexico City, Mexico
plastimagen.com.mx/2020/en

HanoiPlas – Hanoi Int'l Plastics & Rubber Industry Exhibition

10. - 13. 03. 2021

Hanoi, Vietnam
www.chanchao.com.tw/en/

Solids Dortmund

17. - 18. 03. 2021

Dortmund / Germany
www.solids-dortmund.de

CHINAPLAS

13. - 16. 04. 2021

Shenzhen / P.R. China
www.ChinaplasOnline.com

NPE2021

17. - 21. 05. 2021

Orlando, Florida, USA
<http://npe.org>

No Trade Fair Appearances in 2021

■ Vetaphone has withdrawn from all major trade show participation in 2021. The decision comes on the back of numerous show postponements in 2020 and is an acknowledgement of the changed trading conditions brought about by the Covid-19 pandemic.

Speaking for the company, CEO Frank Eisby explained: "The health and safety of our employees and customers remains our top priority in these unusual and difficult times. We have not had a physical presence at any international trade show in 2020, and with no way of knowing what impact the Covid virus will continue to have going forward, have taken the decision not to commit resources for such events in 2021."

Despite the challenging trading conditions this year, global business has remained buoyant for the Danish company, which has been innovative with its sales and support teams and utilized the raft of new online technology that is available. This included a highly successful online launch of its new Test Lab facility earlier in the year.

"We are all increasingly aware of the environmental impact of our carbon footprint, and transporting exhibition stands and displays around the World is becoming morally as well as financially unsustainable. Far better, that we invest these resources in new concepts that will bring a more personalised approach to customer contact and the sharing of our knowledge and expertise," he added.

Plans are already well advanced for regional and global online events in 2021 that will focus on improved customer interaction and offer a safer and more sustainable approach than that offered by trade shows. As an acknowledgment to the importance of the Asian market, and to continue the company's growth in this sector, Vetaphone will commit to a limited trade show presence in the region in 2021.



CEO Frank Eisby said the company will find new and better ways of interacting with customers in 2021

CHINAPLAS 2021: Plastics Industry Responds Impressively to the Pandemic



Machinery maker Reifenhauer converted an extrusion pilot R&D line to produce nonwovens used in personal protective equipment, such as medical coveralls

■ Since early 2020, the global coronavirus pandemic has disrupted the normal rhythms of nearly every aspect of business and life unlike anything any of us has seen. In China, companies can now consider 'post-pandemic' scenarios, but many others elsewhere are still firmly in the grip of the virus. The plastics industry has felt the convulsions of this as much as any other sector, but it responded quickly and admirably. The impact on plastics-intensive end markets has been varied. The automotive and construction industries were among those that felt the squeeze. Packaging and health-care, on the other hand, have witnessed a surge in business, as their vital products and services filled key needs across the spectrum.

The environmental backlash against single-use plastics withered – at least temporarily – as health-care facilities and daily services such as restaurant takeaways opted for the safety of inexpensive, use-and-dispose products over the prospect of needing to sanitize and sterilize potentially infected items. Many plastic product makers quickly shifted their focus to making items to help address the pandemic — face masks and other personal protective equipment (PPE), clear shielding, ventilators, nasal swaps, virus test kits and vials, small bottles for hand sanitizer, and the like. Global auto makers converted some of their production lines to make complex medical ventilators. Materials firms adjusted accordingly, as well, to try to keep up with demand. In one of the highest-profile cases, employees at Braskem Americas in late March worked 28-day shifts at two U.S. plants, with teams sleeping in the factories for a month, to make the polypropylene needed to make PPE.

The drastic, COVID-inspired change in human behavior, with all the self-isolating and sheltering in place, led to a boom in e-commerce, including online grocery shopping and food

delivery. This, in turn, vastly boosted demand for effective packaging for such items.

When it comes to packaging, the pandemic has shone a bright light on hygiene concerns, causing packagers to consider material choice with cleanability and consumer safety at the forefront.

There are hundreds, if not thousands, of examples, but here are just a few that help to illustrate the industry's innovative response to this unexpected challenge.

PTI Engineered Plastics of Macomb, Michigan, says health-care already counted for some 70% of its business before the pandemic, but it still was negatively impacted, since many of the products it made were used in elective surgeries and procedures that were widely postponed due to COVID. So the firm adapted and developed and manufactured a face shield with a visor strap. It estimates it has donated about \$1.1 million worth of masks so far.

German machinery maker Reifenhauer GmbH & Co. KG converted a pilot blown-film extrusion line at its R&D technology center to make nonwoven materials for medical gowns and protective gear.

The pandemic also spurred huge demand for clear plastic sheeting, with rigid partitions being installed at everything from retail check-out counters, banks and restaurant dining areas to public transportation, to help minimize drivers' contact with passengers. Ohio-based Plaskolite LLC earlier this year devoted its 10 plants to making thin, glycol-modified PET (PETG) sheet for face masks, churning out enough to make 3 million masks a week at one point.

Many of these materials, processes, products and companies will be participating in CHINAPLAS 2021 in Shenzhen next April 13-16.

The contagious virus has prompted many establishments to install clear, protective shielding, such as this polycarbonate sheet that helps separate bus drivers from their passengers



POWTECH WORLD – Online Content and Successful Restart in China

■ POWTECH WORLD is a network of the world's leading trade fairs for mechanical processing technology. Alongside the leading international fair POWTECH and the PARTEC Congress in Nuremberg, the event network includes POWTECH India and IPB China.

Although some events had to be postponed in recent months due to the coronavirus pandemic, IPB China was able to chalk up a successful restart. The event welcomed 109 exhibitors and some 8,800 visitors over three days from 29 to 31 July 2020, underscoring its position as the No. 1 venue for Chinese powder and bulk solids experts in the post-coronavirus era as well. Meanwhile, the webinar series POWTECH Virtual Talks got off to a successful start in the summer and has featured interesting topics like digital transformation or measuring and control technology. In addition, a new online magazine about POWTECH WORLD is fostering dialogue and networking within the POWTECH community.

The International Powder and Bulk Solids Processing Conference & Expo (IPB) was probably the first major event in the bulk solids industry to be held under the new circumstances. Almost all the 8,867 visitors came from within China. The organisers, NürnbergMesse China, put extensive safety and hygiene measures in place to mitigate risk at the event. Despite worldwide travel restrictions, the event was therefore able to reach visitor numbers at roughly the level of the 2018 round. The more than 100 exhibitors also included many of the most important international brands, each represented by their local Chinese subsidiaries or partners.

For as long as live events are still largely on hold due to travel restrictions, POWTECH is offering an online dialogue platform specifically for the powder and bulk solids processing industries: POWTECH Virtual Talks. The webinar con-

Exciting exhibits, professional dialogue: IPB China could successfully take place in summer 2020
(© NürnbergMesse China)



cept is well-structured and dialogue-focused. Each round of the Virtual Talks brings together three experts representing longstanding POWTECH exhibitors or end-users. For each topic, a 15-minute TED-style presentation is followed by another 15 minutes of questions and discussion points. "We launched this format with our partner APV as an experiment in the spring of 2020. It was fascinating for us to see how well professional dialogue and interaction can also function online," says Beate Fischer, Director POWTECH at NürnbergMesse. Apart from the APV (International Association for Pharmaceutical Technology), other associations involved in the programme are the VDI-GvC (VDI Association of Process and Chemical Engineering), the training institute VDI Wissensforum, and the DSIV (German Powder and Bulk Association).

As of now, the POWTECH WORLD magazine offers exhibitor and product information from the entire POWTECH WORLD network, presented in an entertaining way in the style of a magazine. The online English-language magazine bridges the gap between all the POWTECH WORLD events and offers exhibitors a global platform where they can present their new products. A new issue of the magazine will appear to coincide with every POWTECH WORLD event.

► NürnbergMesse GmbH
www.powtech.de/en

interpack 2021 cancelled

■ In agreement with its partners in associations and the industry, and with the trade fair advisory committee, Messe Düsseldorf has decided to cancel both interpack and components 2021, scheduled to take place from 25 February to 3 March, due to the restrictions related to the Covid-19 pandemic.

"We have done everything we can to do justice to interpack's tremendous importance for the processing and packaging industry, even during this pandemic – above all because we have received encouragement from the industry in support of a face-to-face event and have a hygiene concept that

has been tried and tested in practice in place to protect everyone involved. Ultimately, however, feedback from our exhibitors has shown that the uncertainty is too great, and we are thus unable to host an interpack event that would meet the standards of a leading international trade fair," explains Wolfram N. Diener, CEO of Messe Düsseldorf. "We are now focussing on the next edition of interpack, which will take place in May 2023 according to plan, and which we will supplement with extended online offers," Diener goes on to explain.

► Messe Düsseldorf GmbH
www.interpack.de

Fakuma 2021 – Industry and Technology Barometer in Preparation

■ Preparation for the 27th Fakuma international trade fair for plastics processing – 12 to 16 October 2021 – is currently running at full bore. The trade fair, regarded internationally as the first port of call for injection moulding, extrusion technology, thermoforming and 3D printing, is being awaited by the industry as an indispensable live platform. At the moment, Fakuma-Virtual is proving itself a useful instrument for presenting trade visitors with innovations covering all aspects of materials, machines, peripherals, processes, simulation, technologies and tools, as well as plastics processing. Many exhibitors are taking advantage of the opportunity to present their trade fair highlights and new developments here, and to get in touch with an expert audience. However, the virtual marketplace is neither capable of replacing the personal professional exchange between suppliers and users, nor does it have any intention of doing so. The Fakuma 2021 on-site event is and will remain indispensable, for which planning and preparation are currently running at full bore. As an industry and technology barometer in the field of plastics processing, Fakuma will attract special attention, in particular in the wake of this pandemic year. Large numbers of projects and products have been developed in recent months in order

to contain the spread of the virus – for example protective and shielding systems, as well as glasses and masks – which will be presented as polished concepts in 2021. In addition to products and solutions for preventing the spread of infection, above all issues including environmental compatibility, sustainability, efficient use of resources, circular economy and bioplastics are at the top of the list. Special emphasis will be placed on the recycling sector – the recyclates market was under considerable pressure in 2020 due to cheap new materials resulting the drop in raw material prices. As a result, recyclates have been driven out of applications which had been built up over numerous years, and the demand for PET flakes has collapsed. Not least of all within this context, the issue of PET bottle concepts and reusable packaging systems will be discussed at Fakuma 2021. In the meantime, many companies have honed their production concepts with regard to automation, digitalisation, networking and efficiency, and have been able to implement up-to-date applications. And thus Fakuma 2021 is being especially eagerly awaited as a trade fair which, as a working platform for seasoned practitioners, is consistently aligned to the plastics processing sequence.

► P. E. Schall GmbH & Co. KG
www.fakuma-messe.de
www.fakuma-messe.de/fakuma-virtuell/

plasmec
 Excellence in Mixing

For over **50 years** a landmark
 in the international market
 for the **manufacturing**
 of **complete mixing plants**

PVC DRY BLEND - POWDER COATINGS
 MASTERBATCH AND PIGMENTS - THERMOPLASTIC RUBBER
 WOOD PLASTIC COMPOSITES

PLAS MEC S.R.L.

Via Europa, 79 - 21015 Lonate Pozzolo (VA) ITALY
 Tel: +39 0331 301648 - E-mail: comm@plasmec.it
www.plasmec.it



PLASTPOL 2020

■ From 6 to 8 October Targi Kielce offered an abundance of the latest technologies in plastics and rubber processing and converting. One hundred forty-seven companies from 12 countries (Austria, Czech Republic, Denmark, the Netherlands, Lithuania, Germany, Poland, Serbia, Slovenia, Switzerland, Ukraine and Italy) marked their presence at this year's PLASTPOL.

Although the exhibition was slightly less impressive than those in previous years, the event still fulfilled its function. Plastpol proved to be an effective business platform – exhibitors have confirmed that the project was justified and in great demand: "We are here first and foremost to show that the company is alive in these difficult times and not afraid to exhibit its products. Targi Kielce seems to have done everything to protect us epidemiology-wise the surveys, decontamination gates area available. The expo centre has done everything in its power. We are to showcase here because I think that without face-to-face business meetings, every industry will perish. There is no chance for other sectors to survive without meetings. Experience exchange, opportunities to show new technologies are a must. Not everything can be

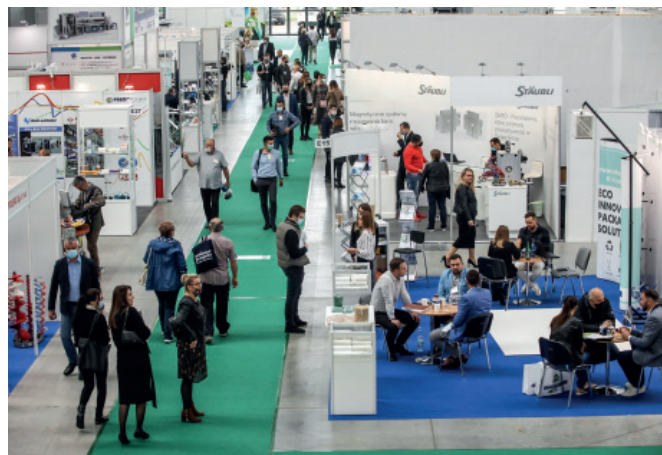

shown on the Internet," said Sławomir Malenta, Euro SITEX Polska. Traditionally, the production processes were demonstrated live during the expo.

The BioPlastics zone was a novelty of the 24th International Fair of Plastics and Rubber Processing PLASTPOL which featured biodegradable, compostable and bio-based products. The expo stand zone attracted the participants' attention because of its wide range of products complemented with consulting, research and certification services. Raw materials, components, additives for bioplastics processing, machines and devices dedicated to the bioplastics sector, media, associations and industry organisations also marked their presence in this zone.

The PLASTECH – INFO Technical Seminar was also a part of the show, the seminar held on the second day of the trade show, i.e 7 October - this year's event's the motto, and the main focus is "Plastics as Environment and Human Life Friendly Materials". The seminar thematic scope mainly referred to the negative image of plastics.

The 25th PLASTPOL is to be held from 25 to 28 May, 2021.

► Targi Kielce S.A.
www.targikielce.pl/plastpol

interplastica 2021 in Moscow Cancelled

■ The trade fairs interplastica and upakovka scheduled for 26-29 January 2021 in Moscow, have been cancelled and will take place on their next regular dates, 25-28 January 2022. This is Messe Düsseldorf's response to the ongoing pandemic situation and the current tightening of quarantine regulations in Russia. interplastica is the most important business platform for the Russian plastics and rubber industry. Messe Düsseldorf Moscow is currently investigating to what extent it can offer interested companies other presentation

options for 2021. The next regional trade fair as a live event will be the already firmly established interplastica Kazan, parallel to the Tatarstan Oil, Gas & Petrochemicals Forum in the Republic of Tartastan/Russia in September 2021. The exact date will be announced.

► Messe Düsseldorf GmbH
www.messe-duesseldorf.de

New Agent for Brazil, Paraguay and Bolivia

■ battenfeld-cincinnati announces TECHFINE located in São Paulo, Brazil as their new agent. This partnership offers efficient plastics extrusion solutions and process engineering from a single extruder to a complete extrusion line for the construction and infrastructure market of Brazil, Paraguay and Bolivia.

“This is an important change in the handling sales and service strategy of both companies, consolidating their long experience in these markets. We have been working in the machinery and extrusion lines market for this sector throughout Latin America for 20 years, and we are very happy to join the battenfeld-cincinnati team, a company whose presence in Brazil dates back more than 4 decades to install machines of the highest quality”, reports Bruno Sommer general manager of TECHFINE.

“Counting on a team with more than 20 years of experience in the plastics industry, TECHFINE supplies quality European equipment and has extensive knowledge of the extrusion industry the needs of our customers. We are looking forward to a positive cooperation in the future,” says Gernot Dorn, Director Sales Construction.

“This agreement solidifies our commitment and focus to the Brazilian customers and is a strategic step to business growth in this market”, says Andreas Türk, Director Sales Infrastructure.

TECHFINE offers tailor-made solutions with the outstanding extrusion technology of battenfeld-cincinnati to meet the expected production requirements associated with the new sanitary law and framework in Brazil and the already consolidated demand from local manufacturers.

The TECHFINE team will provide sales and after sales services from its base in São Paulo with own local technical engineers.



Bruno Sommer

■ battenfeld-cincinnati
www.battenfeld-cincinnati.com

TECHFINE
www.techfine.com.br

motan[®] 
colortronic[®]

Gravimetric conveying made easy

 think materials management

METROFLOW

Gravimetric conveying thanks to state-of-the-art technology.

motan-colortronic gmbh - info@motan-colortronic.de
www.motan-colortronic.com

Course Charted for K 2022



Left to right: Erhard Wienkamp (Managing Director Operative Trade Fair Business), Petra Cullmann (Executive Director Operative Trade Fair Business), Ulrich Reifenhäuser (Chairman exhibitors' advisory board) and Thomas Franken (Project Director for the Portfolio Plastics & Rubber) (Image: Messe Düsseldorf GmbH)

■ On 22 October 2020, the first meeting of the exhibitors' advisory board marked the kick-off to the next 'K' in Düsseldorf to be held from 19 to 26 October 2022. The body of experts has met to chart the course for the most important trade fair for the plastics and rubber industries worldwide and to enter into the concrete planning stage. The exhibitors' advisory board supports Messe Düsseldorf in the preparations for 'K 2022' and provides consulting on basic conceptual and organisational issues. Here particular attention is paid to considering current developments as well as to the global

economy and the discussion of forward-looking trends and technologies.

The advisory board of 'K 2022' is composed of representatives from the exhibiting industries and leading trade associations. It mirrors the complete spectrum of ranges represented at 'K' in Düsseldorf, mechanical and plant engineering, raw and auxiliary materials as well as semi-finished products, technical parts and reinforced plastic products.

Acting as the Chairman for the exhibitors' advisory board again will be Ulrich Reifenhäuser, Managing Partner of the mechanical engineering company of the same name and Chairman of VDMA's Plastics and Rubber Machinery Association. The communications committee of 'K 2022' will be headed by Thorsten Kühmann, Managing Director of VDMA's Plastics and Rubber Machinery Association.

Alongside them, the exhibitors' advisory board of 'K 2022 Düsseldorf' includes the following members: Marc Gregor Baier (BBP Kunststoffwerk Marbach Baier GmbH), Michael Baumeister (Brückner Maschinenbau GmbH & Co. KG), Siamak Djafarian (Röhm GmbH), Boris Engelhardt (wdk - Wirtschaftsverband der deutschen Kautschukindustrie e.V.), Dr. Guiscard Glück (BASF SE), Manfred Hackl (EREMA Engineering Recycling), Juliane Hehl (Arburg GmbH & Co. KG), Vedran Kujundzic (Borealis AG), Matthias Lesch (Pöppelmann GmbH & Co. KG Kunststoff-Werkzeugbau), Dr. Ulrich Liman (COVESTRO Deutschland AG), Dr. Oliver Möllenstädt (GKV Gesamtverband Kunststoffverarbeitende Industrie e.V.), Klaus-Uwe Reiß (Pro-K), Dr. Michael Ruf (KraussMaffei Group GmbH), Dr. Ingo Sartorius (PlasticsEurope Deutschland e.V.), Dr. Christoph Steger (Engel Holding GmbH), Peter Steinbeck (Windmüller & Hölscher KG), Pascal Streiff (EUROMAP).

► Messe Düsseldorf GmbH
www.k-online.de

Acquisition

■ ALPLA Group has taken over a plant for rigid plastics in India from the global packaging specialist Amcor with effect from September 28, 2020. The plant in Alandi, West India, is in the immediate vicinity of the metropolis of Pune. It manufactures preforms for the production of PET bottles for the beverage industry. Customers include Coca-Cola and the Indian dairy company Amul.

With this takeover, ALPLA is expanding its core business in the PET area in India. All 50 employees will be taken over by ALPLA. Vagish Dixit, Managing Director ALPLA India: „The newly acquired facility near Pune will primarily help us to better serve the market in the Western Region of India and further expand existing partnerships with customers such as Coca-Cola.“ ALPLA Pune is the ninth location of ALPLA in India and the second in the west of the country.



Part of the workforce at the newly acquired ALPLA Pune plant (Copyright: ALPLA)

► ALPLA Group
www.alpla.com

Donation Helps Clean Plastics

■ Global sustainable food packaging leader Huhtamaki is donating €600,000 to fund a project that aims to stop the flow of plastic into the Indian Ocean from the Mithi River in Mumbai, India. The project is one of three initiatives that Huhtamaki has funded as part of its 100-year anniversary to address global sustainability challenges and build and learn from circular economy initiatives globally.

The Mithi River project is run by a global partnership between the United Nations Technology Innovation Labs UNTIL, VTT Technical Research Centre of Finland, RiverRecycle and Earth5R. Each partner has a unique role in the project which seeks to use emerging technologies to collect plastic waste from the river and raises awareness on effective waste management in order to drive systemic change locally. The project is also focused on developing ways to valorize waste.

Charles Héaulmé, President and CEO of Huhtamaki, says, "Huhtamaki is committed to protecting people, food and the planet. We are happy to support local initiatives together with partners across the value chain, learning from those experiences, and developing the systemic changes towards circularity and a sustainable future globally."

► **Huhtamäki Oyj**
www.huhtamaki.com

The United Nations Technology Innovation Labs
until.un.org

VTT Technical Research Centre of
www.vttresearch.com

RiverRecycle
www.riverrecycle.com

Earth5R
www.earth5r.org

Precision Wall Thickness Measurement

Zumbach
SWISS PRIME MEASURING SINCE 1957

RAYEX S XT

- Easy and quick set up for new products
- Fast eccentricity and diameter measurement
- Added longevity due to high-quality xray source



Family owned since 1957, Zumbach is a global leader in the industry. Driven by innovation and experience. We are here for you and ready to build the future together.

www.zumbach.com • sales@zumbach.com

Anniversary

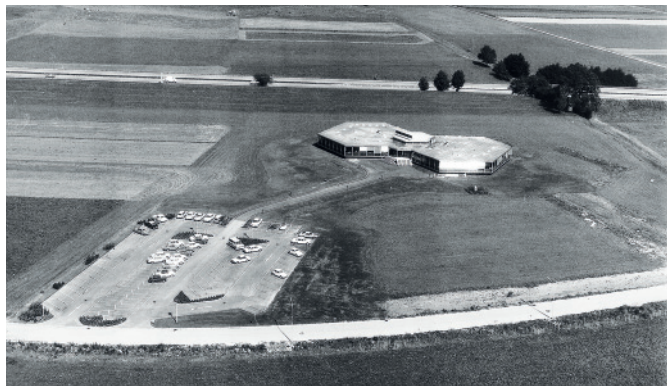

■ In October 1960, exactly 60 years ago, Gernot Brückner started the “Brückner-Trocknerbau owner Gernot Brückner, Tittmoning”, named after him. Originally founded as a supplier for textile machines, the focus was quickly shifted to plastics. The market for the initially small company from Bavaria was already then the whole world. Since 1969, the company has been located in Siegsdorf as Brückner Maschinenbau and can now look back on an impressive company history: Brückner Maschinenbau is the world’s leading supplier of machines and lines for the production of oriented plastic films. The company’s huge, more than 150m long lines guarantee international film manufacturers a highly efficient and reliable production of a wide range of film types, which are used as high-quality packaging material and in technical applications. At present a good 800 film production lines from Brückner Maschinenbau are in operation worldwide. Future topics of technological development include new film types for a circular economy or for electromobility, sustainability in film production and intelligent packaging. Brückner Maschinenbau’s range of services includes the planning, construction and commissioning of film production lines, the realisation of complex industrial projects as well as all process and mechanical engineering developments for film

production. The range of services also includes consulting in project initiation, feasibility studies and financing solutions. In the highly competitive, very narrow market for film stretching lines, it is not least the technological lead that counts. For this reason, Brückner works on research and development projects in its Technology Centre in Siegsdorf, which was inaugurated in 1998, together with raw material manufacturers, film producers and processors on the basic development of film technologies.

With the world’s first simultaneous stretching lines with linear motor drive, the first line with a production width of ten metres or with production speeds of over 600 m/min, Brückner Maschinenbau has repeatedly set new standards.

“Applied research has been carried out from the very beginning, laboratory and pilot lines have always been part of our DNA. Our motto ‘Stretching the Limits’, also stands for the continuous development of our technologies, but also for the untiring commitment and motivation of our employees”, says Helmut Huber, Managing Director for Sales and Project Management at Brückner Maschinenbau.

Over the past 17 years, Brückner Maschinenbau has become a veritable group of companies with a good 2,600 employees at 23 locations in 14 countries.



■ Brückner Group GmbH
www.brueckner.com

iCorona – the Beating Heart of Surface Treatment

■ As with so many aspects of technology, the part that is on show is always the best known and attracts the greatest attention. Surface treatment is no different in that respect, but with Vetaphone, it’s the beating heart at the centre of the system that sets the Danish pioneer’s technology apart from all of its competitors – and that heart is known as the iCorona Generator.

Modular in construction, iCorona is designed to be easy to be efficient, upgradable and easy to maintain to offer the high degree of future proofing that today’s changing market demands. All of the important electronic components are built into one easily accessible module that means servicing is quick and simple, which makes for smoother running and longer life, as all vital parts in the module are updated to the latest technology.



Vetaphone's iCorona generators are the beating heart of the company's surface treatment systems

listed for both the USA and Canada. The advantage of this is obvious – with approval across all continents, Vetaphone can build iCorona generators without needing to know their final destination, which means delivery is quicker and there are no issues relating to type approval or power requirements, which typically sees 50Hz used in Europe and 60Hz in America. iCorona caters for both and its technology also includes a unique patented resonant feedback system that automatically matches the Corona to the substrate being treated.

As befits market leading technology, Vetaphone's iCorona generator is highly controllable. Its standard ICC7 panel is intuitive and compact, making it user-friendly for all operatives. There are plenty of interface options to provide centralised set-up and control from the main machine HMI. The benefit of centralised HMI is that it allows one operator to oversee production, including several lines at the same time. Vetaphone provides free software advice during implementation of the interface, which with graduated feedback provides the operator with only the information required at that stage – although full details are accessible at any time.

And, all this comes within a very compact generator that has a small footprint to cater for today's crowded production floor and is uniquely CE approved for Europe and UL

► Vetaphone
www.vetaphone.com

Sales Agent in France

■ ER-WE-PA Davis-Standard announced that SIFEM Electronique will serve as Davis-Standard's sales agent in France. SIFEM has more than 40 years of experience in industrial projects and extrusion applications encompassing film, sheet, pipe and profile, and wire and cable. As Davis-Standard's representative, they will be responsible for facilitating direct contact with plastic converters and stakeholders throughout France, specifically identifying converting needs and marketing packaging solutions.

"SIFEM has reputation for being a dynamic and responsive partner. Their team is known for listening to customers, whether it is for new equipment, a replacement or retrofit project, repair or technical services," said Daniel Schiller, Area Sales & Project Manager of ER-WE-PA GmbH. "We look forward to working with them as they market our multi-faceted converting solutions and other extrusion technology in France. We also look forward to expanding our reach there and being able to offer regional service through our facility in Germany. "

► SIFEM
www.sifem-extrusion.com

Davis-Standard, LLC
www.davis-standard.com

From the Simple to the Sublime



Series 800 crosshead for two to six layers

The latest generation of the **Series 800 crosshead** is designed to run two to six layer extrusions for high quality, high accuracy 1/8" to 6" OD tubing for medical, automotive, appliance and industrial applications.

Ideal for fluoropolymer multi-lumen, multi-layer tubing for fuel lines or thin layer combinations of polymers and adhesives to 0.02mm or less.

Features patented **Guill Feather Touch®** concentricity adjustment to eliminate leaking.

Please visit www.guill.com



Guill
EXTRUSION TOOLING

10 Pike Street
West Warwick, RI 02893
USA
sales@guill.com Attention: Bill Conley

Used Machinery Trade

■ The GINDUMAC Group, with locations in Germany, Spain and India, is a pioneer of platform business in the used machinery trading market and is one of the leaders in Europe. As of October, the Schuhe24 Group entered as majority shareholder. "Gindumac is a fast-growing and unique platform for machines which are sold worldwide. We have therefore decided to accompany the growth as majority shareholder and to further expand the platform business," says Dr. Dominik Benner, Managing Director of the Schuhe24 Group in Wiesbaden.

The founders and managing directors, Janek Andre and Benedikt Ruf, will remain on board and continue their successful growth course. Following the entry of Schuhe24, the shareholders of the Gindumac Group are thus Krauss-Maffei, Leis-Holding, the two founders and Schuhe24.

"We started with the aim of digitizing the used machinery trading and making it transparent, fair and simple with our online platform. We have successfully achieved this, and we will continue to grow significantly in the Corona year 2020. With Schuhe24 we have gained an ambitious partner who, with its many years of experience in e-commerce and platform business, opens new growth potential for us," says Janek Andre, CEO of the GINDUMAC Group.

For Benedikt Ruf, this is also a signal for the sustainability of the locations: "We have numerous employees in India and our main location is Barcelona. With Schuhe24, we will expand the



From left to right: Janek Andre, Dr. Dominik Benner, Benedikt Ruf

locations, hire new employees and, above all, recruit more sales representatives in order to double the number of machines on offer".

The Munich-based machine manufacturer, KraussMaffei Technologies GmbH, which acquired a stake in GINDUMAC in 2018, welcomes the entry of Schuhe24 and the resulting growth potential.

For the future growth strategy, the partners want to initiate a clear expansion course, which also includes new countries. So far, Gindumac machines are sold in over 30 countries.

■ GINDUMAC Group
www.gindumac.com

Bioplastics Meet all EU Safety Standards

■ Products made from bio-based plastics must undergo the same testing procedures as conventional plastic products to access the market of the European Union (EU). Thereby a health risk for consumers is excluded. Plastics intended to be certified as biodegradable or compostable must undergo additional tests. "Products made of bioplastics thus pass even more tests than conventional plastic products," explains Hasso von Pogrell, Managing Director of European Bioplastics (EUBP).

In the EU, plastic products with food contact have to comply with strict regulations. These have to be met by bio-based as well as by conventional plastics. The relevant Commission Regulation, (EU) No. 10/2011, contains requirements for migration tests. A migration limit value indicates the maximum permitted quantity of an ingredient to transit into food. The limit value ensures that food contact material does not pose a health risk to consumers. In addition to the migration test, the composition of multi-component materials is checked. Only those substances and materials that have been assessed and listed in an EU overview as safe may be used in their manufacture.

Biodegradable plastics certified for industrial composting according to EU standard EN 13432 have to meet a fixed limit for

heavy metals and other toxic and hazardous substances. Also, an ecotoxicity test is carried out in accordance with the OECD1 rules. This test examines possible effects of industrial compost on plant growth and its toxicological harmlessness to microorganisms. Agricultural mulch films certified as biodegradable in soil according to EU standard EN 17033 must comply with strict SVHC² guidelines. This ensures that the films do not contain substances of very high concern. In addition to a further test for nitrification inhibition, EN 17033 certification also includes a procedure to exclude negative effects on soil organisms such as earthworms. A standard for the home composting of carrier bags (prEN 17427) expected to be published soon by the European Committee for Standardization (CEN) will summarize all test procedures once again.

¹ Organisation for Economic Cooperation and Development. The test used is OECD 208.

² Substances of very high concern.

■ European Bioplastics
www.european-bioplastics.org

Washing Line in the UK

■ Herbold Meckesheim supplies a plant with an input capacity of approximately 10.000 tpa for film recycling in England. It is designed for 100 percent post-industrial stretch film. A demanding application for wash lines, as it represents an extremely high surface area and low bulk density. The plant is another step to cover the growing demands for high quality plastic recycling in the UK. According to its Government, an additional tax on plastic packaging is very likely to be introduced in 2022. The initial amount accounts to £200 per ton on packaging which does not include at least

Herbold Film Washing Line

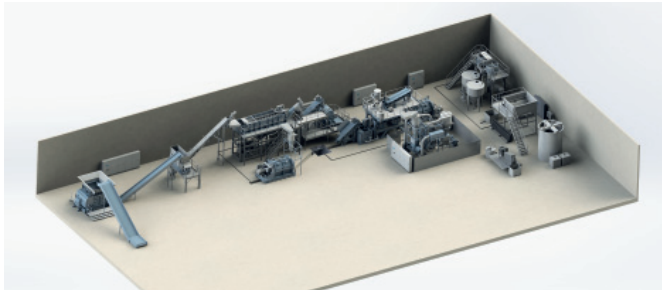

30 percent recycled material. This will encourage the demand for high quality recycle.

One of the highlights of the latest project is the HERBOLD EWS 45/200 shredder which is used as a pre-shredder prior to the wet granulator. The new concept particularly enhances the accessibility to the knives and sieves on behalf of a user-friendly handling. A gearless belt-driven propulsion system in combination with a mechanical clutch, offers additional protection against demolition caused by foreign bodies. The rotor can be equipped with variable knife configurations and as an option with easy to change armour-plating.

In order to obtain the highest quality of the final product, a hydrocyclone is used instead of a conventional separation tank which achieves higher separation levels, exerts more friction upon the material, hence generates purer flakes. These considerably better outcomes were confirmed prior to the customers' purchase decision via tests carried out in the Herbold test center.

Herbold Meckesheim is in a good position to comply with increasing demands for high quality plastic recyclates. The latest washing plant generation makes a major contribution to more circularity in England.

Herbold Meckesheim GmbH
www.herbold.com

WEBER

Innovation. Quality. Partnership.

IF screw technology from WEBER

Discover our innovative extruders with the latest **IF screw technology** to optimize your processes.



20% higher energy input

possible compared to comparable conventional screws.

Your solution for the future:
www.hansweber.de

Certification

■ Millad® NX® 8000 technology is fully compatible with polypropylene (PP) recycling processes in Europe and poses no recyclability issues, according to RecyClass, a cross-industry initiative that works to advance plastic packaging recyclability on the continent.

RecyClass approval applies to the technology itself, while the packaging using the technology must adhere to certain conditions[1] to be considered fully compatible with the PP recycling stream. These include the maximum content of the technology of 0,4% compared to the overall packaging weight.

Testing was conducted by Plastics Forming Enterprise, in accordance with the APR PP Critical and Application Guidance protocol[2]. Recyclates generated via recycling of packaging containing this clarifying agent can be used in high-quality applications. In this protocol a concentration limit of 50% is tested.

Millad NX 8000, including its variants Millad NX 8000E, for PP blow molding applications, and Millad NX 8000 ECO, a sustainable clarifying agent for PP, is used by more resin producers than any other, making it the number one clarifier for PP in the world.

Millad NX 8000 not only transforms polypropylene into a crystal clear alternative to glass, PET, PVC and PC, but boosts sustainability.



Millad® NX® 8000 for PP certified by RecyClass for plastic packaging recycling in Europe (Photos © 2020 Milliken & Company)

In addition Millad NX 8000 ECO addresses concerns related to migration, especially in food contact applications, by reducing Specific Migration Limits, or SMLs, without adding any new ingredients to the formulation. Millad NX 8000 ECO also maintains a consistent, fresh appearance in all retail lighting, regardless of the presence of UV light from the light source.

[1] Download the Approval letter here: <https://recyclclass.eu/wp-content/uploads/2020/10/2020-PP-001-Milliken-technology-approval-letter.pdf>

[2] PRE and APR are part of the Global Plastics Outreach Alliance.

Where appropriate and applicable for Europe, RecyClass can approve technologies based on the results of tests conducted via APR protocols.

► Milliken & Company
www.milliken.com

New Location in Singapore

■ Lindner has been doing business in Asia for over 20 years now. In recent years in particular, a greater awareness of the need to manage resources responsibly and, above all, to recover waste materials, has grown in the world's most densely populated region.



The Asia-Pacific region has become one of the largest growth markets in the waste management sector. Lindner Recyclingtech, one of the world's leading suppliers of shredding technology and system solutions for recycling, is now strengthening its presence in the region with its new subsidiary in Singapore, thereby expanding its international service and distribution network.

"We already have very strong partners with whom we successfully implemented numerous projects in countries such as China, Japan, Korea, Thailand, Malaysia, the Philippines and also Australia. With the new service and sales hub in Singapore, we've created a point of contact for partners and clients to better respond to individual local needs and also react quickly across time zones," explains Gerhard Gamper, Sales Director at Lindner Asia-Pacific. Besides sales and logistics staff, and contacts to help with the supply of wear parts, the site will also be home to highly qualified service technicians trained directly at Lindner's headquarters. These regional advantages, combined with the new hub, the subsidiary in the US and the European headquarters, mean our support team is now readily available to a much larger international customer base. "We set very high standards for our machines and in particular for our services worldwide. I am therefore delighted that we are now closing the loop with Lindner Asia-Pacific and will be even closer to our clients in future. That's exactly what our service strategy is about," summarises Gamper.

► Lindner-Recyclingtech GmbH
www.lindner.com

New Head of Global IT Appointed

■ As Head of Global IT, the IT specialist Robert Kubotsch is taking on overall responsibility for information technology at Kautex Maschinenbau. With this appointment, the global leader in extrusion blow molding machines has filled another key position to steer and support its process of change. Robert Kubotsch will harmonize the existing IT systems and optimize them for cooperation between the global Kautex team, customers and partners. Isolated solutions which have been used to date will be replaced with a uniform IT structure at all locations, and the availability of IT services and infrastructure at crucial points will be improved.

Kautex Maschinenbau has been involved in a process of strategic realignment and restructuring for over two years. The company is bringing about harmonized processes and standards in line with the BeOne motto, as well as placing even greater emphasis on customer focus in all business areas. The production solutions are becoming more intelligent, modular, and flexible, and the aim is primarily to generate added value for customers.

These changes are accompanied by increasing digitalization in communication, production, and service. Data management, communication systems and comprehensive remote services place high demands in terms of the efficiency, standardization and global availability of IT. Kautex announced enhanced investment in this area some time ago. Robert Kubotsch and his team will now put the philosophy into action.



Robert Kubotsch
(© Kautex Maschinenbau GmbH 2020)

■ Kautex Maschinenbau GmbH
www.kautex-group.com

Certification as Recyclable Material in Europe Earned

■ TOPAS Advanced Polymers has announced that its TOPAS® cyclic olefin copolymer (COC) products have earned certification as recyclable materials by the European independent testing lab, Institut cyclos-HTP, based in Aachen, Germany. TOPAS materials are the first cyclic olefin resins in the industry to be deemed recyclable with polyethylene (PE) and polypropylene (PP) for film and injection molding uses. TOPAS® COC has been certified as a recyclable polyolefin as part of the EU initiative for a circular economy. "This designation is a major development for brand owners, manufacturers, and processors who seek recycled packaging solutions to meet today's sustainability needs," said Wilfried Hatke, sales and marketing manager, EMEA, for TOPAS Advanced Polymers. "COC is a key enabler and opens many opportunities in shrink labels for decoration and other applications such as polyolefin-based high-barrier films and recyclable pouches."

The findings by Institut cyclos-HTP conclude that COC can be considered as valuable material in post-consumer LDPE, mixed polyolefin, and polypropylene recycling streams. Consequently, PE and PP formulations modified with COC can be considered fully recyclable in their respective waste streams. Moreover, in view of the fact that current multilayer packaging usually contains polyethylene terephthalate (PET), polyamide (PA), or other polymers required for a functional package, COC with its intrinsic stiffness and barrier properties can help to develop attractive, functional, and fully recyclable polyolefin solutions.

■ TOPAS Advanced Polymers
<https://topas.com>

Institut cyclos-HTP
www.cyclos-htp.de/publications/r-a-catalogue/

LIANSU
Plastic Extrusion Technology

**20-1200mm HDPE Pipe
Multi Layer Co-extrusion Technology**

www.ls-extrusion.com
info@liansu.com

European Recycling Product Manager Appointed

■ Dirk Mylich has assumed the new position of Bunting's European Recycling Product Manager. The appointment reflects the ever-growing importance of environmental management in Europe and the necessity of employing technology to successfully recover and recycle secondary materials such as metal and plastic.

Bunting is one of the world's leading designers and manufacturers of magnetic separators, eddy current separators and electrostatic separators for the recycling and waste industries. The Bunting European manufacturing and product testing facilities are in Redditch, just outside Birmingham, and Berkhamsted, both in the United Kingdom.

In recent years, Bunting has developed a reputation in the recycling and waste sector as one of the leading designers



and manufacturers of metal separation and recovery technology. The extensive equipment portfolio includes high-intensity magnetic separators to recover fragmented stainless-steel; eddy current separators to separate both large and small non-ferrous metals, and the new electrostatic separator for enhanced separation of fine metals such as copper wire and other small metal particles. Product development is ongoing with new metal separators scheduled for release in 2021.

"Our business in the recycling sector continues to grow, especially as we develop enhanced metal separation technology," explained Simon Ayling, Bunting's European Managing Director. "The appointment of Dirk brings additional knowledge and expertise to our sales team. From his base in Germany, Dirk will provide local support for our existing and potential customers in the region. He will also support our network of sales people and representatives across Europe. It is another exciting appointment for Bunting."

Dirk joins Christopher Gabriel and Stefano Maiaroli in Bunting's expanding European mainland-based sales team.

Bunting
Buntingeurope.com
www.mastermagnets.com

New Website

■ OCS Optical Control Systems presents itself on the internet from a completely new side. With a clear design within the modified corporate design and modern visual language, the facelift of the website has resulted in major optical changes. The user-friendly product filter provides a coherent presentation of OCS equipment and system solutions for the required application, tailored to the target group.

"Already in the planning phase of the new company website, it was important to us, in addition to an appealing and professional appearance, that the visitors profit from a comprehensive information content of our product solutions and that we are able to provide important information according to the interested parties," explains Senior Marketing Manager Jessica Bonnes in a positive mood about the successful launch. In addition to the name modification of the products and the content structure & expressiveness, the website has been adapted to the latest technical possibilities. Improved traceability via search engines and, moreover, perfectly usable on all end devices. The respective product information is also directly available as a product download or can be saved via bookmarks.



(Picture © OCS)

In so-called cases, these customer needs and benefits are explained in detail in experience reports.

OCS Optical Control Systems GmbH
www.ocsgmbh.com

New Market and Technology Report: Chemical Recycling

■ The report provides deep insights into current developments in order to assert a position in the current discussion based on clear definitions and categorisations of all technologies. More than 70 companies and research institutes, which developed and offer chemical recycling technologies, are presented in the report. Each company is listed with its technologies and status, investment and cooperation partners. Additionally, the report provides an overview of waste policy in the European Union. And finally, 10 companies and research institutes were interviewed to receive first-hand information around the topic of chemical recycling. The current life cycle of plastic products shows gaps. Overall, 30 million tonnes of plastic waste are generated annually in Europe from which about 29 million tonnes are collected. The majority of the collected plastic waste is incinerated or landfilled which are the least desirable options according the waste hierarchy. Besides conventional mechanical recycling a wide spectrum of chemical recycling technologies is moving into focus in the context of discussions on the improvement of current recycling rates. Chemical recycling technologies are presenting innovative options to deal with post-consumer waste and offer a range of alternatives that are not available in current material recycling pathways. Since these new technologies are in early development stages, developers are facing the challenge to prove their potential. Proponents of chemical recycling see

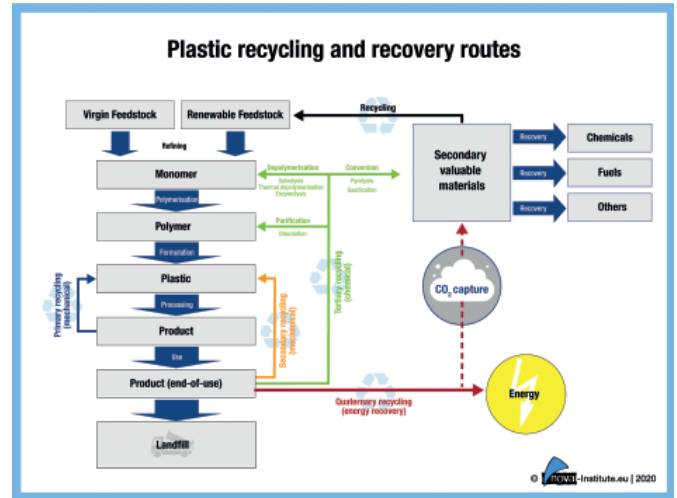

the latest technologies as core technologies of the circular economy and the European Green Deal while critics refer to the technologies' lack of maturity and the wide uncertainty ranges of existing assessments.

■ nova-Institut GmbH
www.nova-institut.eu

"The Bullet™" Extrusion Head

■ Guill Tool introduces The Bullet™, a new extrusion head with fixed center design, multi-port spiral flow design and gum space adjustment, plus the added feature of no fasten-

The Bullet, showing the absence of hardware, i.e. nuts and bolts, so disassembly, cleaning and restart are made easier

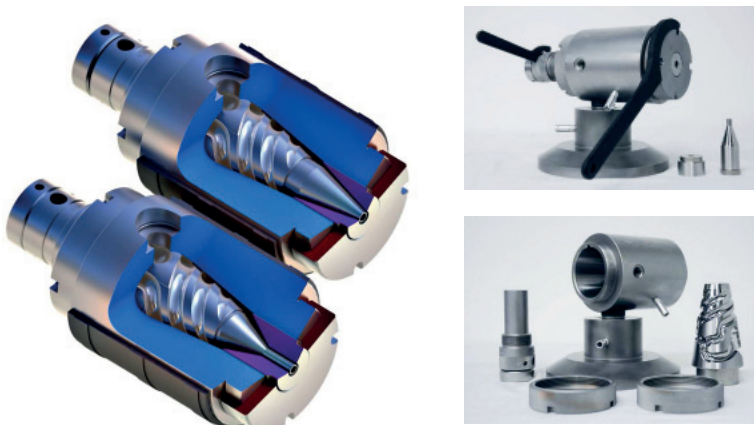

ing hardware, so cleaning and restart are easier and faster than any conventional head on the market currently, according to company sources.

The Bullet allows quick tooling changes, as the tips remove from the back and the die removes from the front of the unit. The absence of fastening hardware eliminates leaking, as does the taper body and deflector design pioneered by Guill.

High- and low-volume applications are suitable for this head and are accommodated with the simple, easy changing of just one component. A family of crosshead designs is available and users can specify the "caliber", that is, the max. die ID.

A vacuum chamber and kit for assembly and disassembly are included with the unit. Optional keyed tooling capability offers machine designers and end users quick orientation, so the overall unit design enables faster disassembly, proper cleaning and restart, allowing the line to become more profitable.

■ Guill Tool & Engineering Co., Inc.
www.guill.com

"Cable business – 2020"

■ The "Cable business – 2020" conference organized by the cable industry media leader RusCable.ru finished its work in Saint Petersburg. For over 7 hours, headliners of the conference – general directors of the leading cable producers of the country – as well as experts and guests exchanged experiences and discussed current issues of the industry.

The event was offline and online and united around 800 (up to 1,000 at the peak of online connections) representatives of the cable business, producers of cable polymers and industry experts. R&P POLYPLASTIC, the leading Russian producer of polymer compounds took part in the business session in an online format.

"Our company develops and produces compounds including materials for oil submersible cables and "Cable business – 2020" presented a great opportunity for strengthening business relations," said Ekaterina Smirnova, Head of Market Development Department of R&P POLYPLASTIC. "We had three business meetings and discussed details of further cooperation with our partners. We also had the opportunity to provide detailed information about Armlen PP-6EX and Armlen PP-9EX materials".

Compounds for oil submersible cables under Armlen PP-6EX and Armlen PP-9EX brand names are developed based on block copolymer of propylene with ethylene and is characterized with increased resistance to impact of temperatures, copper ions and petrochemicals. These thermostabilized frost



resistant materials are used in production of cable sheathings for oil submersible pumps with operating temperatures over 125°C.

■ POLYPLASTIC GROUP
www.polyplastic.ru

Recycling – Collaboration

■ Chemical Recycling Europe is pleased to welcome Recycling Technologies, a United Kingdom based company as a new member of the association. The company is a leader in the United Kingdom in developing chemical recycling. It has developed an innovative technology, the RT7000, which turns hard-to-recycle plastic such as films, bags, laminated plastics into an oil, called Plaxx®, used as a feedstock for new plastic production. The RT7000 is modular and small-scale, designed to fit easily onto existing waste treatment and recycling sites, providing a scalable solution to recycle waste plastic anywhere in the world.

ChemRecEurope Secretary General, Mohammad Hayatfar, said: "We are delighted Recycling Technologies has joined our association. It is a leader in the UK having set itself a mission to accelerate the evolution of plastic into a sustainable material. The company is already expanding its reach into Europe where it is working with Citeo, Mars and Nestlé to develop chemical recycling in France and recently announced plans to build its first European site in the Netherlands. We are looking forward to working

together with this new member to increase the circularity of plastic."

Adrian Griffiths, Founder and Chief Executive Officer said: "We are delighted to join Chemical Recycling Europe; we share its vision to close the loop for the plastics industry by offering the technology to endlessly recycle all plastic waste back into its original components. This industry body has achieved a great deal since it was founded in 2019, working with stakeholders across the plastics industry to drive the growth of recycling processes for many more plastics and to accelerate the transition to a more sustainable plastics future. Collaboration is key to addressing the goals and the challenges of advancing the plastic circular economy and moving away from incineration, export and landfill, towards making waste plastic valuable."

■ Recycling Technologies
www.recyclingtechnologies.co.uk

Chemical Recycling Europe
www.chemicalrecyclingeurope.eu

Large Die Cart with Crosshead Introduced

■ Guill Tool announced the immediate availability of its new die cart with easy disassembly and reassembly. It features a high volume, adjustable center accumulating crosshead. This crosshead is designed to produce a smooth linear bore and provide jacketing over various substrates. The crosshead's maximum thru core is 18," while its' maximum die ID is 23". Built to handle thermoplastic applications, the crosshead includes tooling and isolation sleeve design.

Additionally, the tooling section features quadrant heating. Guill's crosshead stand is equipped with an integral alignment station and concentric role guide. The stand is also an integral cleaning station, so clients don't need to remove the crosshead for cleaning. Lastly, this crosshead has "on-the fly" catenary adjustment and can be easily maintained with simple hand tools.

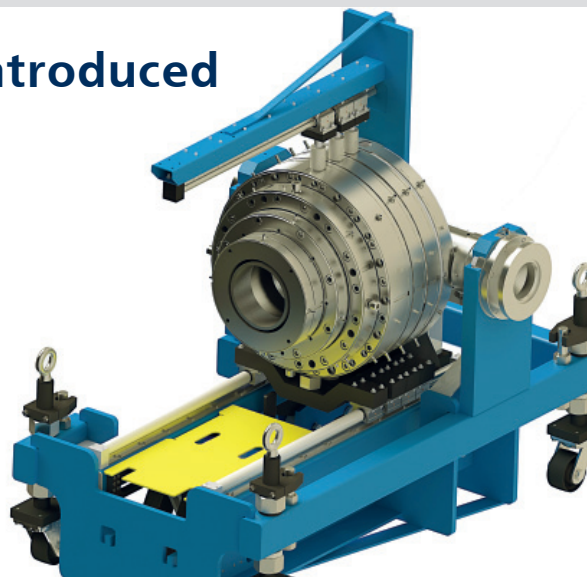

■ Guill Tool & Engineering
www.guill.com

New HDPE Recycling Plant in Mexico

■ ALPLA Group, a global specialist for packaging solutions and recycling, continues to pursue a strategy of expanding its recycling activities worldwide. The family-owned enterprise from Austria is now building a plant in Mexico for recycling HDPE. It is planned to produce 15,000 tonnes of post-consumer recycled material each year.

ALPLA has acquired a property in Toluca, capital city of the State of México in the country's centre. Construction of a state-of-the-art recycling plant commenced on it in autumn 2020, with its launch planned for the second half of 2021. The amount invested is roughly 15 million euros and 65 jobs will be created. The company will be run as a 100-per-cent subsidiary of ALPLA, while the facility will have an annual capacity of 15,000 tonnes of HDPE recycled material for non-food applications, for example for packaging solutions for personal care or household cleaning products. The target markets are primarily Mexico, neighbouring countries in Central America and the United States.

By making this investment, ALPLA is realising its global objectives for the New Plastics Economy (an initiative of the Ellen

MacArthur Foundation). Secondly, the family-run company is staying true to its regional strategy, as Georg Lässer, Head of Recycling, explains: „ALPLA has been demonstrating forward-looking action in the field of recycling for many years. We invest in regions where the demand for recycled material is not yet that high. In doing this, we give used plastics value and act as role models for the achievement of the circular economy.“ Carlos Torres, Mexico Regional Manager, adds: „This is how we generate demand among collection companies and support the development of the necessary infrastructure. In addition, we can offer our regional customers the ‚circularity‘ demanded of recyclable materials.“

ALPLA possesses many years of experience in recycling post-consumer PET in Mexico. The first bottle-to-bottle recycling plant in Latin America commenced operation back in 2005 with Industria Mexicana de Reciclaje (IMER). IMER is a joint venture between ALPLA México, Coca-Cola México and Coca-Cola Femsa. By joining forces, the partners have established the infrastructure for collecting and recycling used PET beverage bottles over the last 15 years. They produce almost 15,000 tonnes of food-grade recycled material from post-consumer PET each year. ALPLA is seeking to utilise this network and vast experience in its development of HDPE recycling within the region.

ALPLA announced its acquisition of two recycling plants in Spain in November 2019, taking its first step in the field of HDPE recycling.

Rendering of the new recycling plant for HDPE in Toluca, Mexico (Copyright: ALPLA)



■ ALPLA Group
www.alpla.com

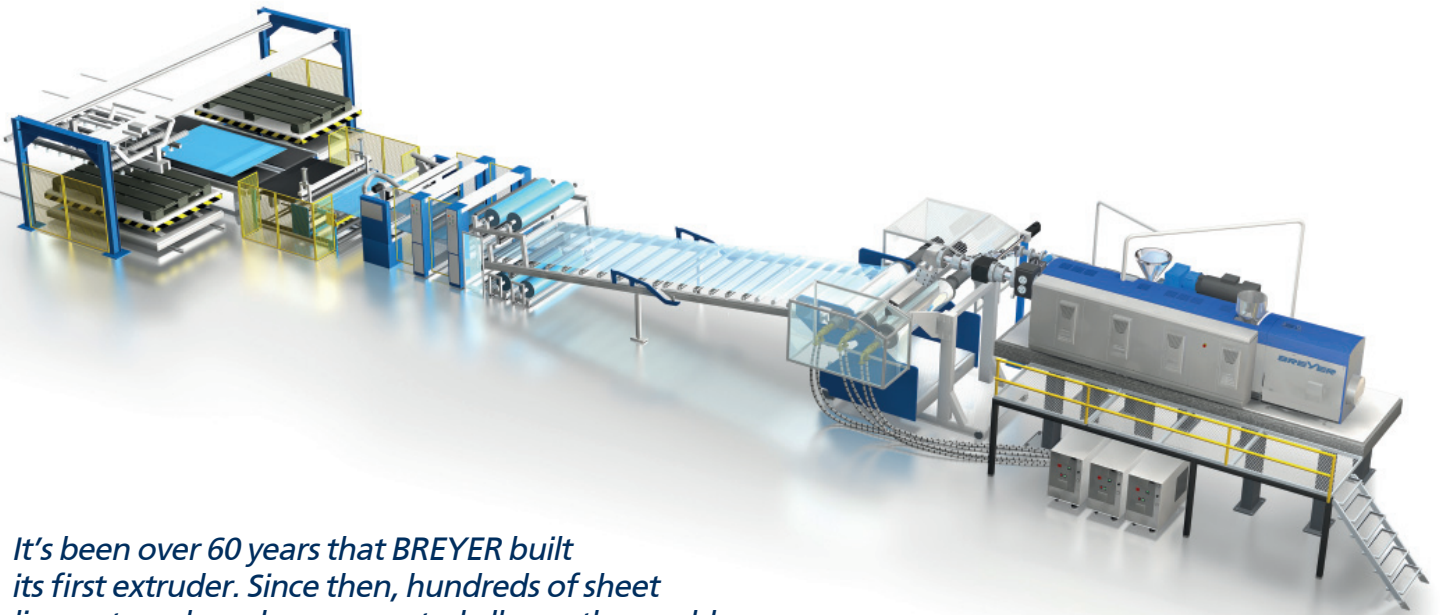

It's been over 60 years that BREYER built its first extruder. Since then, hundreds of sheet line systems have been exported all over the world. Most important to the success of BREYER Extrusion Lines was a close collaboration of machine manufacturers, raw-material suppliers and sheet manufacturers

Successful Extrusion of Clear Sheet Needs a Multi Tool

A lot of details and know-how was developed this way, inuring to the benefit of the customers' efficient and flexible production. In the range of crystal-clear sheets customers produce worldwide highest quality, capturing new markets with first-class products.

Meanwhile, the range of application for transparent sheet is huge. Architectural applications like huge buildings and giant stadiums, green house roofs and machine coverings

on the one side and high sophisticated applications like TV and computer screens, mobile phones and LED panels for illumination panels on the other side. Recently another application has been added to the picture: Sheet for the personal protection in offices, hotel receptions and supermarkets.

To produce sheet for all this different markets and requirements the extrusion line must be like a multi tool.

High performance on vented extruders
To have also a good economical production result, the line starts with a vented single screw extruder with outstanding performance.

As a pioneer on this field, BREYER even successfully managed to process hygroscopic materials at high specific throughputs without the necessity of pre-drying the material. This way the time- and energy consuming pre-drying becomes obsolete.

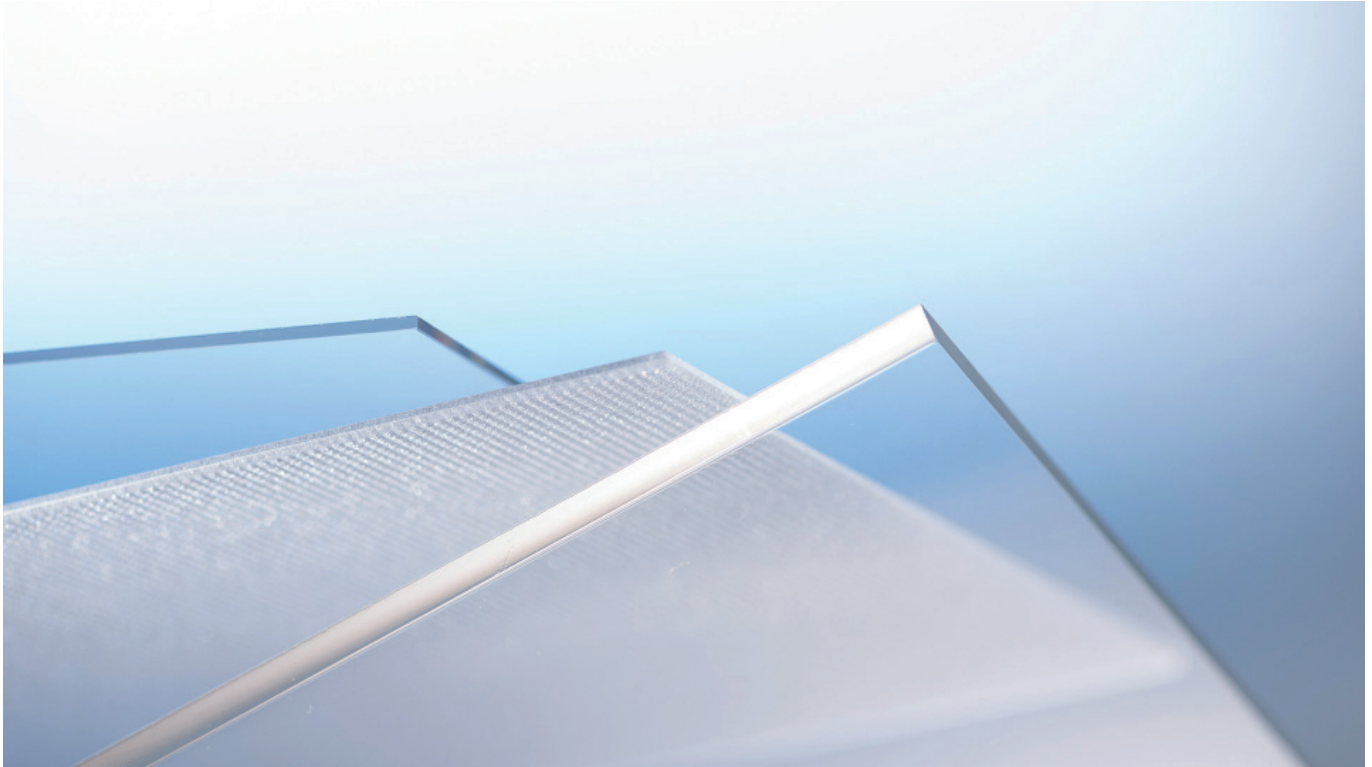

Changeover times related to material properties significantly can be reduced compared to conventional processes based on pre-drying technology; hence the entire extrusion line can get operated far more flexible and significantly more efficient. All BREYER extrusion lines processing high quality PC, PMMA and PETG sheet or even films for optical application do follow the undried and vented process. The melt will become optimally degassed, a precondition for the production of first class sheet and films meeting highest quality demands of the worldwide market.

One calender for 3 types of sheet surface

To serve to the whole market the product line is able to produce three different kinds of sheet: mat and structured sheet as well as both side polished sheet with optical properties.

Thanks of the quick-exchange-device of the first and center calender roll, the machine can be fast converted for different types of sheet. In this way the machine becomes highly flexible.

Depending from the total output (kg/h) the calenders with three and four rolls with different roll diameters are available.

Quick adjusting the flatness

Flatness of the sheet is essential. By the BREYER calender with its slewable third calender roll is not anymore a matter of many minutes. By this feature the residential time of the sheet around the center calender roll is influenced. During running condition the position of the third roll in relation to the center roll can be changed, resp. adjusted exactly to this position where top and lower side cooling is balanced and the film becomes flat.

Changing quick from one thickness to another

The BREYER gap control system allows a precise and fast adjustment of the gap, simply by changing the extrusion speed at the touchscreen (pressure control mode) especially for thinner sheet. The operator changes the speed value on the touch screen in accordance with the new product

thickness, and within a matter of seconds the product is set to the desired thickness. This is a clear advantage in terms of time and costs compared with conventional gap adjustment systems, which require the operator to adjust the speed separately, after the gap adjustments have been implemented.

BREYER offers the complete extrusion system including gravimetric dosing systems, side-trim saws and cross-cut saws as well as stacking systems.

The entire control system is according the latest standard, and the BREYER e-Portal offers different online support solutions for the operator.

All these features described make the BREYER extrusion line a real multifunctional tool and enable the operator to set up an economical and flexible sheet production.

Vietnam – Setting New Standards for Standard Blown Film Machines



The Vietnamese plastic sector has grown significantly in the past 5 years thanks to many unique advantages that the country has. The ability to produce lower cost yet good quality plastic products is ideal for export markets such as the US, Japan, Europe, Australia and Cambodia. The local market demand is also increasing in sectors such as live seafood packaging, industrial and agricultural film, in a country of large population of nearly 100 million

Since 2016, Polystar has already been working with 42 producers in Vietnam and has installed 187 sets of blown film extruders for various applications such as general packaging (garbage bags, vegetable and fruit bags, shopping bags), seafood packaging and industrial packaging.

Although many of the Polystar blown film machines installed are simply standard one-layer machines, Vietnamese producers have found major differences in many areas compared to their existing machines (mostly Chinese and locally made): Better film quality, higher output capacity,

lower power consumption, and better thickness variation control.

The upgrade in quality of the end product (film and bag) has helped the producers to create competitive advantage in the market. The improvement in efficiency reduces the production cost and gives them the advantage to grow and expand year by year.

Setting new standards in film quality

In the case of the company Volga, a producer located in Long Anh province has already set a new standard for the local market for LLDPE bags in terms of quality. "We are able to produce better quality film using the exact same materials," said Mr. Tuan, who has invested in ten more sets of Polystar in 2019, after having tried the first machine back in 2018. "This gives us a great advantage in the market, and we are able to dictate a better selling price." Volga now produces one of the best quality film products in the local market, with more than 90% of its film products coming from Polystar machines.

Higher productivity. Lower operation cost

Another bag producer located in Ho Chi Minh City – Tam Sao, has been expanding from 300 tones per month to 800 per month thanks to its ability to produce good quality yet low cost plastic bags, which are now exported to Europe, Thailand and Cambodia.



"Our goal is to expand to 1,500 tones per month, and we rely heavily on Polystar blown film extruders to stay competitive in the market." Mr. Ho, the owner of the company, has replaced all of its Chinese made blown film machines step by step with Polystar extruders since early 2016. "We were surprised that a simple machine can make such a big difference in operation. To be honest, we had doubts in the beginning to invest in more expensive machines when we saw the price, as the initial investment on machines was more than doubled from our previous machine suppliers, but we are so happy afterwards that we made the right decision 4 years ago."

Speaking about his key to success and fast growth during an onsite visit in 2019, Mr. Ho said that he calculates the overall operation cost carefully and found out that investing in better machine is actually more cost-saving. "The machine investment is, in fact, a relatively small percentage of our total operation cost which includes material, electricity, space and labor costs," he added. "If you invest in the right machines, all of these other costs come down and the investment comes back in less than one year," Mr. Ho emphasized. "I would say this is the most important factor that has put us ahead of other competitors."

Mr. Ho is satisfied that since having switched to Polystar machines, he has been able to reduce operation and labor costs significantly. "When we produce the same product on a Polystar twin head 55mm extruder, the output is almost doubled comparing to a similar spec machine we had before. We've saved so much factory space and operation cost, basically producing more with less numbers of machines and less operators."

To further cut down production cost, the company uses a very high percentage of calcium carbonate compounds



(CaCO₃) and recycled material. “We can load a high percentage of CaCO₃ in the Polystar extruders, sometimes up to 60~80% in mono layer,” he emphasized. “This was not possible before with other machines.”

Simple operation – stable operation

A fifteen-year-old company, Minh Huy Long, who recently completed its new factory putting only Polystar machines, says that simple and stable operation is the main reason why he has chosen Polystar as his long-term partner for expansion. “Our operators love to work with the POLYSTAR blown film extruders, and so do I,” said Mr. Bai, the owner of the company who has been working with machines since decades ago when he was just a technical operator. “Our operators simply need to start the machine, stabilize the film bubble, and the machine will just go on and run for hours. It’s simple and stable,” he added. “Less down time equals less maintenance cost. In our past experience with other machines, we had to constantly go back and adjust on the settings as the production was not as stable. More production waste was generated, and our operators could not manage multiple machines at one time,” Mr. Bai jokingly said. “With the Polystar machines, they can just start, sit back, relax and watch. The Polystar machines are always the first ones they

start in early morning, so they can go work on other machines after that.”

The stability of the blown film machines also ensures product stability of other machines involved in the production process, such as bag making and printing machines. The even thickness control on the Polystar extruders make sure that the film rolls produced are well-prepared for the process that follow – it makes the bag making/converting and printing process much easier. “The bag making machines can seal better, and we have less defected products as a result,” Mr. Bai added. “When our customers are happy, we are happier.”

100% export, 100% Polystar

The public-listed company located in Dong Nai province, who has invested in more than 30 sets of Polystar since 2016, has designed its new factories for 100% export purposes. It focuses on various products including draw tape garbage bags, star-sealed, bag-on-roll, T-shirt and shopping bags, exporting 100% to Europe, Australia and the US. “We are very proud to show our international buyers the machines when they visit our factory,” said Ms. Thao, marketing manager of the draw-tape garbage bag producer. “Polystar is a global brand that is also well known in the countries where we export our products to. During the factory tours, our customers recognize that we have invested in quality machines, this helps them understand our commitment in product quality and why we should be their valuable long-term partner and supplier,” she added.

“The machines cover a wide range of products that we need to produce,” said Mr. Su, technical director of the factories dedicated for export products. “HDPE, LDPE, LLDPE, virgin, recycled or CaCO₃, you name it, we use only Polystar extruders for our export products because it produces the quality our customers need,” he explained.

New standards, new thinking

The director of Vipaco, a well-known film producer located in Hanoi who has started using Polystar in 2016, has witnessed the change in the market. “In the past, you could find maybe one or two companies using machine from Taiwan in the bag production market. Now you see Polystar everywhere in Vietnam.”

“In a way,” said Mr. Tuan, who focuses on export markets for Japan and the US, “Polystar has changed the entire market and industry in Vietnam, setting new standards for standard machines,” he added. “More and more producers start to understand why they should invest more for quality machines.”

Environmentally Friendly Deep-Drawing Films – Thin and Mono-Material

Kuhne Anlagenbau GmbH, the blown film system specialist from St. Augustin, Germany, has developed innovative deep-draw thermoforming films for packaging food products such as bread, meat and cheese in collaboration with its customers. The highlight of these multi-layer films, which are produced on Triple Bubble® blown film lines, is their reduced thickness, which is up to 50% less than that of conventional cast films, and their high barrier properties despite their mono-material composition. Thus, the improved property profile of these films offers clear advantages to comparable cast films



The requirements for thermoforming films for food packaging are substantial: high barrier properties for a long shelf life of the packaged goods, sealability, printability, appealing surface properties and gloss. In addition, they should have the lowest film thickness possible and possess good thermoformability. Although cast film extrusion is an established manufacturing process for deep-draw thermoforming films, clear advantages can be obtained with the Triple Bubble® technology. Kuhne Anlagenbau has taken the first step to demonstrate this through extensive tests on their 13-layer Triple Bubble® system at their in-house R&D center. "We have succeeded in producing films that, compared to 150 to 180 µm thick cast films, are only 80 µm thick. This represents a dramatic thickness reduction of roughly 50%," says Managing Director Jürgen Schiffmann, describing the first big step on the path to more environmentally friendly thermoforming films.

Not only does the significant reduction in thickness speak in favor of these films; another plus is their ideal machinability for deep draw thermoforming. Triple Bubble® films thermoform better than comparable cast films, according to the initial feedback from customers who have already produced the films for German food companies. Jürgen Schiffmann sees the reason for this in the manufacturing process: After the film is abruptly quenched in the first film bubble, and thus has an extremely low degree of crystallinity, biaxial stretching takes place in the second bubble. This biaxial stretching improves the high barrier properties significantly. However, the relaxation and fixation that the film undergoes in the third film bubble is decisive for deep-drawability. In addition to the optimal deep-drawability, the films score with a perfect thickness distribution in the final packages. "Despite the overall reduced film thickness, the corners and curves of the thermoformed packages are just as reliable as when using conventional films. However, the wall thicknesses of the packages, though significantly thinner, are more uniform," the managing director emphasizes.

The Triple Bubble® films for deep-drawing applications that are already in the market are typically 9-layer struc-

tures with EVOH and PA barrier layers. That is why Kuhne Anlagenbau has gone one step further and, together with a European film manufacturer, has developed a 5-layer PP-based so-called "mono-material" film. This environmentally friendly film consists of 95% PP with only 5% of foreign material and is therefore recyclable. The first deep-drawing tests with the new, thin and recyclable film at the film manufacturer were absolutely convincing. This film has excellent machinability and leads to very uniform and stable packaging solutions.

With these innovative films, Kuhne Anlagenbau not only demonstrates its mechanical engineering concepts, which are perfectly tailored to the market, but also its development skills. "Deep-drawing films that are produced on our Triple Bubble® lines represent a quantum leap in terms of thickness reduction and recyclability", summarizes Jürgen Schiffmann while inviting interested customers to further development cooperation and test runs in the R&D center in Sankt Augustin.

► Kuhne Anlagenbau GmbH
Einsteinstr. 20, 53757 Sankt Augustin,
Germany
www.kuhne-ab.de



Today, plastics processors feel a responsibility toward the environment and are always looking to optimise their production processes with regard to sustainability and energy efficiency. This of course starts with careful use of the resource: plastic. Internal factory waste is seen as a valuable raw material, collected and recycled and in many cases virgin material is replaced as far as possible by secondary, repelletised material



ABS and PS Sheet for Technical Components – Melt Filtration as the Key to Increased Efficiency and Recycled Content

This also applies to the manufacture of ABS and PS sheet for technical applications. The properties of thermoplastics such as PS and ABS are particularly well suited to recycling.

Melt Filtration as the Key to Increasing the Proportion of Recycled Material

When considering the use of recycled material in a process such as ABS and PS sheet for technical applications, it is important not only to consider the effect of the recycled material on the properties of the product, which has to achieve strict and stringent quality requirements.

The process and the economics of the process itself must not be compromised by down time, variations etc. The Melt Filtration system is perhaps “the” key to enabling the use of recycled material without compromising production efficiency whilst maintaining the high-

est possible product quality. However: whilst the typical screen changers usually supplied as original equipment with extrusion lines are generally acceptable when processing only virgin material, they quickly become a bottleneck in the production process as soon as recycled material is used in any quantity.

A major German manufacturer of PS sheet for thermoforming to technical parts recognised this aspect early and equipped three extrusion lines with Gneuss RSFgenius Melt Filtration Systems. By retrofitting the extrusion lines with these systems, they were able to re-use all their internal waste: not only edge trim but also the skeletal waste and off cuts from the production of the thermoformed parts themselves.

Another well known German manufacturer of ABS and PS sheet for technical applications (e.g. for vehicle interiors) retrofitted their extrusion lines with

the Gneuss RSFgenius Melt Filtration System in place of the original equipment screen changer which was supplied with the extrusion line.

When selecting a Melt Filtration System for a given application, it is important to consider not only the ability of the system to handle the contamination load which the recycled material brings - and to achieve the required filtration fineness, but also the impact of the system on the process consistency. This is another area where the Gneuss Rotary Melt Filtration Systems offer a major advantage: The Gneuss RSFgenius system for example, can operate with a guaranteed pressure consistency of +/- 2 bar even when processing heavily contaminated recycled material. Thanks to the efficient, electronically controlled high pressure purging system, the screen packs can be regenerated in situ up to 400 times. This can mean intervals be-



Gneuss Process-constant, Fully- Automatic Self-Cleaning Screen Changer RSFgenius

designed with retrofitting to existing lines in mind.

Fast Return on Investment Thanks to Individually Engineered, Tailor Made Solutions

In addition to offering a range of highly efficient, process-constant Melt Filtration Systems, Gneuss also has a team of experienced specialists whose speciality is integrating their systems into existing extrusion lines. In close dialogue with the customer, individual solutions are worked out so that the processor can retrofit a Gneuss system into their existing extrusion line with an absolute minimum of conversion work and disruption, thereby ensuring that the customer can immediately take advantage of the efficiency improvements and a fast return on investment is ensured.

► Gneuss Kunststofftechnik GmbH
Mönichhusen 42, 32549 Bad Oeynhausen,
Germany
www.gneuss.com

tween screen pack changes of several months (during which the system operates without attention) and replacement of the screen packs takes place without production disturbances.

Most screen changers developed for recycling were developed for repelletising lines, where there are few space constrictions. The Gneuss Rotary Filtration Systems however are compact and



“We are here for our customers, even in challenging times.”

Interview with Gerhard Hehenberger, CEO ECON Group



What does ECON pride itself in as a company?

Gerhard Hehenberger: Since its foundation in 1999, ECON has recorded a steady and stable growth, which has made us a successful company. It is particularly pleasing that we were able to establish our brand on the world market in this very short period of time. The worldwide success of ECON is based on the innovative ECON-technology. Numerous patents and awards, such as the State Prize of Innovation, verify our inventive spirit.

What stands out about ECON's underwater pelletizing systems?

Hehenberger: First of all, our machines offer a high process stability. Our unique technology - the patented thermal insulation – makes a perfect production possible. To meet the needs of our target group we offer tailor-made solutions for every customer. As a development partner, we constantly implement new customer-specific solutions. Our customers especially appreciate our fast and short decision-making processes, as well as technically excellent and durable products. Our customer service department is also a very important part of the company. Fast response times and high availability of technicians characterize our customer service. The training of our employees is our focus, as we want to ensure a high service quality. Furthermore, we offer various customized service agreements to guarantee a fast delivery of spare parts. As a modern company, we ensure that we can support our customers at any time. Therefore, we are permanently improving our remote service system.

Which products/projects are you very proud of?

Hehenberger: In 2019 we introduced our innovative product ECONia – the first fully automated pelletizing system. From my point of view, we were able to set another milestone with this machine. Therefore, it is a very important product development. This special machine combines the advantages of

thermal separation and industry 4.0. An integrated robot takes over the usual operating processes, such as starting the machine, as well as changing the knife carrier. This automation step enables the operator to operate and control more than 10 lines simultaneously from his control center. The integrated artificial intelligence makes the production much more simple and efficient. An inline monitoring system measures the pellets to ensure the best quality.

How does ECON deal with the current situation?

Hehenberger: Like many other companies, we are facing new challenges due to the current situation. ECON is using this extraordinary time to build up personnel for the future and to offer employees the opportunity to expand their expertise. Thus, we are preparing for the time after the pandemic. As a reliable partner, we have even sent a service technician to the USA in order to provide our customers the best possible local support - even in challenging times.

What are some of the challenges facing the company and how are they overcome?

Hehenberger: The current international travel restrictions and the cancellation of trade fairs – as the most important communication channel – make market development a task that we had to rethink. However, the digital world offers a real possibility to be there for our customers. The challenge here is to find the right communication channels to reach our target group. It is therefore essential to stay up-to-date permanently.

What does the future hold for ECON?

Hehenberger: As in the past, ECON will continue to focus on the development of innovative products in order to meet customer needs as best as possible. We have also planned to develop new markets and thus create a positive future for ECON.

Thank you for our conversation Mr. Hehenberger.

■ ECON Head office Austria
ECON GmbH
Biergasse 9, 4616 Weißkirchen/Traun, Austria
www.econ.eu, office@econ.eu
Subsidiaries in China, USA and India

New Extrusion Equipment Standards

The patented helical screws by Hans Weber Maschinenfabrik offers both performance and economic benefits for plastics processing companies who are focusing on PVC extrusion. These companies face such challenges as new product ideas, consumer resistance to PVC products, and continuing demand for product quality; it is especially true for PVC materials with a high content of filler agents and reinforcing materials, ground products, recycled materials, wood-plastic composites, and peroxide cross-linked polyethylene (for example, PEX-a pipes)

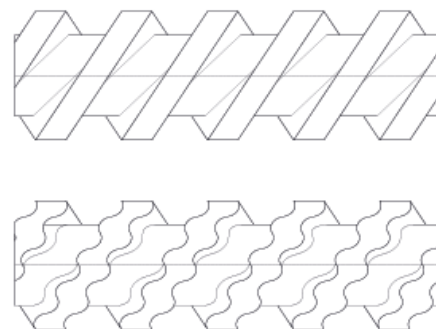

A German extruder manufacturer has optimised the extrusion Screws with a new patented geometry (IF-Screw® technology) for twin-screw extruders with counter-rotating screws bringing a new momentum to the thermoplastics industries. With the so-called helical screws or IF-screws (interference) Weber have developed a new generation of extrusion screw that provides more cost-efficient extrusion for plastics processing companies. This new screw concept is characterised by higher output, reduced raw material costs and improved product quality. The new screw technology enables processing methods that could not previously have been fully implemented and in some cases not at all using conventional twin-screw extruders with counter rotating screws. The patented screw design also provides new opportunities for pelletising of shear-sensitive materials with high requirements of homogeneity and proper dispersion. A perfect helix for high-capacity twin screw extruders as compared to conventional screw designs in twin-screw extruders, the helical screw channels feature a helical shape circumferentially. This results in a curvilinear motion of the screw PVC-filled C-chamber. Exposed to intermittent load, this plasticising effect generates additional internal friction between the PVC grains and acceler-

ates the transfer of more mechanical energy to the polymer material. The performance of this innovative method was field-proven repeatedly over the past years. "The point is that screws which are manufactured under the IF-Screw technology enable the transfer of 30% of additional energy to the material as compared to using conventional screw design" underlines Dr. Markus Weber, CEO of Hans Weber Maschinenfabrik. The critical advantages of the patented helical IF-Screw® technology are capacity increase, higher product quality, lower material costs even when materials with a high content of filler agents or recyclates are used. Besides this, the screw enables capacity increase without increasing the L/D ratio. Both very low and very high screw speeds ensure good plasticisation. Thus, the extruder utilisation and flexibility increases. "The prevailing opinion that "longer is better" can now be dispelled. The helical screw channels increase the effective length by approximately 15%, while the L/D ratio remains the same. We managed to increase capacity by 25% for PEXa processing," says Rainer Vießmann, the Senior Process Engineer responsible for innovations at Weber. Good homogenisation resulting from the screw design also provides high performance for the processing of dry cold mixtures.

This has huge potential for energy saving. In general, an extrusion company will notice the benefit of savings in terms of the mixing duration and feedstock/ energy costs. Customisation right from the start, Weber develops tailored solutions with consideration of the material properties jointly with customers. All the solutions are based on German engineering ingenuity coupled with extensive experience in the field of production process and machinery. Our family enterprise has been committed to quality and reliability since 1992. Weber offers comprehensive services and focuses on a long term partnerships with customers. Among our main advantages are a customised approach, quick response and availability of spare parts, including those for older models which are no longer in our product range. "Our modernisation service includes advising and offering optimised solutions to increase the capacity of the operating Weber machines by retrofitting. According to our vast experience, modernisation of a production line is way more efficient than replacing it. Thus, we adhere to the sustainability concept," concludes Dr. Markus Weber.

Hans Weber Maschinenfabrik GmbH
Bamberger Str. 20,
96317 Kronach, Germany
www.hansweber.de

“The most outstanding advantages of the new extruder are low melt temperature with high output” is how Fuad Dweik, Managing Partner of Palad HY Industries Ltd., domiciled in Migdal HaEmek, Israel, sums up his assessment of the recently commissioned solEX NG 75-40 from battenfeld-cincinnati GmbH, Bad Oeynhausen. He is a long-standing customer of the German machine manufacturer and was the first pipe manufacturer in Israel to opt for the single screw extruder of the latest generation, which offers many additional advantages



Next Generation Extruder solEX NG

Ideal for Large-Diameter Pipes – Less Sagging, Better Quality

Palad HY, which was founded in 1997, ranks among the leading manufacturers of HDPE and PVC pipes in Israel. The ISO 9001:2008-certified pipe producer is well known for its range of large-diameter pipes with maximum diameters of 1,200 mm for HDPE pipes and 500 mm for PVC pipes. In addition to its domestic market, Palad HY also serves customers in Eastern and Western Europe, South America and Africa, to which about 25% of its annual production volume of currently about 20,000 t is exported. The company's product range includes fresh water and sewage pipes as well as pipes for natural gas distribution systems, and protective conduits for electricity and communication lines.

Palad has been a customer of battenfeld-cincinnati right from the beginning and now operates several lines with machines from the extrusion specialist.

“In view of our positive experience with the machine technology from Germany, we have again chosen an extruder from battenfeld-cincinnati for our most recent investment, and we were not disappointed”, Rami Dweik, son of the proprietor and responsible for the production as Deputy Manager, reports. On the contrary! The solEX NG 75-40 installed at the beginning

of this year belongs to the new generation of high-performance single screw extruders from battenfeld-cincinnati.

At Palad, it has replaced an old extruder in a PE 100 pipe extrusion line. “We are particularly impressed with the lower melt temperature compared to the previously used extruder, combined with better melt homogeneity and consequently better pipe quality”, Fuad Dweik adds. Thanks to the lower melt temperature, Palad also achieves significantly more even wall thickness distributions within extremely narrow tolerances, plus less undesirable sagging. Of course, the better pipe quality also reduces material consumption and produces less scrap. “Both the material savings and the roughly 10% reduction in energy consumption due to the lower heating rates make this extruder a particularly cost-efficient alternative”, concludes the General Manager, who is already thinking about a further investment in another solEX NG extruder of the new generation for other existing lines.

The completely redesigned processing unit is responsible for the above-mentioned advantages of the new solEX NG extruders, which are available with screw diameters of 60, 75, 90 and 120 mm and cover a throughput range from

750 to 2,500 kg/h, compared to the well-established and still available predecessor series. The internally grooved barrel in combination with a matching screw and grooved

bushing geometry offers substantial improvements in process technology: a reduced axial pressure profile lessens machine wear, high specific output rates with lower screw speeds ensure high efficiency, and the gentle but highly effective and homogeneous melting performance at about 10 °C lower melt temperatures compared to conventional processing units delivers high end product quality with significant cost savings in production.

Left: Rami Dweik, Deputy Manager
Right: Fuad Dweik Managing Partner of Palad H.Y.

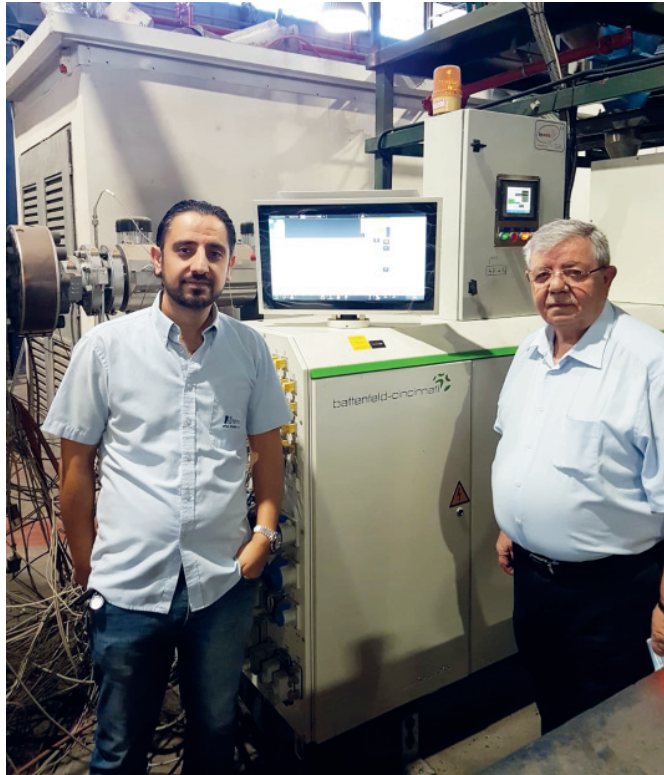

Assuming that energy costs are 0.10 EUR/kWh, about 18,000 EUR in operating costs can be saved due to the 10% lower energy consumption at full output capacity alone. Depending on the machine model compared with, savings of up to 15% are possible. Even higher cost cuts can also be achieved in production by material savings through reduced sagging as a result of low melt temperatures, especially in large-diameter pipe production.

Finally, the pipe manufacturer Palad HY appreciates the extruder's intuitively operated BCtouch UX control system which, in addition to modern functionalities also includes the possibility of individualization or personalized user interfaces. "For our staff, it is a great benefit that the equipment can now even be operated in Hebrew, and that the battenfeld-cincinnati service team is available 24/7", is the final praise for his extrusion equipment supplier expressed by Rami Dweik.

battenfeld-cincinnati
www.battenfeld-cincinnati.com

Palad H.Y. Industries
www.paladhy.com

SMART EXTRUSION

A SPECIALIZED WEB PORTAL

- ▶ News about relevant products and events
- ▶ Detailed reviews of various smart technologies
- ▶ Case studies from processors
- ▶ English, German, Russian and Chinese
- ▶ Video clips demonstrating smart equipment in live action
- ▶ Latest magazines available for reading and downloading
- ▶ Weekly e-mail newsletters

www.smart-extrusion.com

Worldwide, demand for polyolefin pipes (PO) is growing steadily thanks to their excellent physical and mechanical properties, able to outclass the performances of other materials. In this connection, they are emerging as the preferred choice for the construction of sewerage and drainage infrastructure, as well as networks for the Oil & Gas industry, eating away at the metal and cement market shares. By virtue of its role in understanding the needs of the industry for over 70 years, Bausano – international leading player in the design and production of customised extrusion lines for the transformation of plastic materials – introduces E-GO: the renewed range of single-screw extruders for the production of PO pipes, resulting from the expertise of the Bausano technical Team, which has always designed solutions that stand for reliability and quality



Concentrated Technology for Multiple Applications – Renewed Line of E-GO Single-Screw Extruders for PO Pipes presented

The E-GO single-screw technology makes it possible to obtain smooth, corrugated, multilayer or single-layer, rigid or flexible pipes, with a variable diameter from small size to large section, assuring excellent melt homogeneity of plastic materials such as PP, PP-R, PE, HDPE, LDPE, PE-X, PE-RT, PMMA, PC, PA and PU, ideal for a wide range of applications. Several sectors are concerned, namely from construction to infrastructure, laying water and electricity mains and gas pipelines, from agriculture to medical, up to the mining, oil industry and automotive. Compact, efficient and high-performance: E-GO pipe extruders stand out for the screw geometry which, in addition to featuring an ad hoc design developed on customers' requirements, also introduces innovative solutions. This design choice makes it possible to obtain a high output in terms of Kg/hr of the machine and to process poly-

olefins without excessive mechanical stress. What is more, the specific design of both the screw and the cylinder, jointly with the low-input asynchronous motors, guarantee excellent energy efficiency. In addition to that, the solution is designed to assure operating continuity and a superior life cycle of the line, owing to the low wear of the components, which contributes to significant overall savings.

In setting up the line, the head and extrusion tools are noteworthy, as they assure the best pipe processing, while maintaining high capacity. The multi-stage gearbox with ground helical gears, the cylinder heating system with ceramic heating elements and the cooling system with radial fans, the gravimetric doser or sliding hopper are also noteworthy. Plus, the Digital Extruder Control 4.0 makes it possible to monitor consumption and control the extruder and the entire line through a

single user interface. Finally, in case of special processes such as co-extrusion, the E-GO single-screw pipe extruder can also be coupled to a two-screw solution.

"Relying on Bausano means being supported by a partner capable of designing the most appropriate formula to obtain the desired product, with the best turnkey extrusion system," says Clemente Bausano, Vice President of Bausano who concludes, "In this specific case, PO pipes are required to have high properties in terms of resistance to abrasion, to corrosion, to chemical agents and impacts, as well as internal pressure and heat, which Bausano guarantees by customising the core elements of the E-GO line, designed to achieve an unequalled production capacity".

Bausano & Figli Spa
C.so Indipendenza 111, 10086 Rivarolo
Canavese (TO), Italy
www.bausano.com

Powerful and Highly Efficient – Successful Market Launch of the Four Large ZE BluePower Compounding Extruders

The sales launch of the four large ZE BluePower compounding extruders with a throughput capacity of 2,500 kg/h and more started immediately after the K 2019 exhibition. The unique combination of high throughput rates and short set-up times has been extremely well received among numerous large national and international compounding companies. The first machines of this type designed for classical compounding processes as well as for reaction and degassing applications have already been put into operation during the last few weeks

The large free volume and high specific torque enable universal application of the ZE BluePower twin-screw extruders for compounding engineering plastics and even highly filled formulations. Thanks to the 1.65 OD/ID diameter ratio and the torque density of 16 Nm/cm³, these extruders are tailored for any customer-specific application – from the production of compounds, expanded

ZE BluePower twin-screw extruder – Modular processing section equipped with side feeder unit

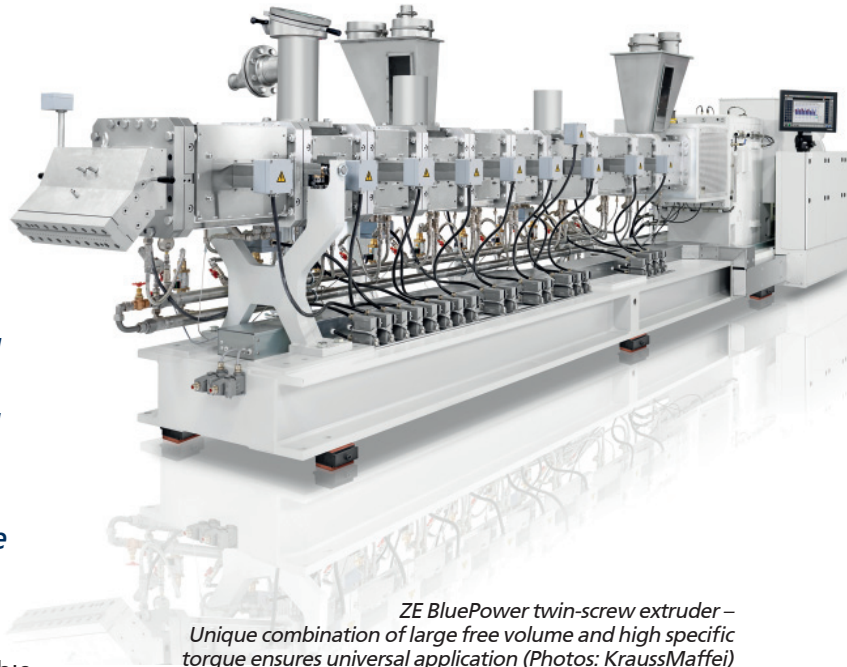

ZE BluePower twin-screw extruder – Unique combination of large free volume and high specific torque ensures universal application (Photos: KraussMaffei)

sheets, biaxially oriented film and sheets up to the processing of recycled material.

Processing section of modular design for uncompromising flexibility

The large extruder variants with screw diameters of 98, 122, 142 and 166 mm still offer the typical screw and barrel modularity. A wide range of 4D and 6D barrel housings and various side feeders and degassing units are available for the extruder configuration. The exchangeable oval liners ensure efficient wear protection of the housings – a crucial benefit in wear-intensive compounding applications in particular.

Minor design modifications have been implemented by KraussMaffei to allow for the size of the new extruders. The housing elements are connected by means of screw unions instead of clamping flanges and the cartridge heaters are replaced by ceramic heaters.

► KraussMaffei Extrusion GmbH
An der Breiten Wiese 3 – 5, 30625 Hannover, Germany
www.kraussmaffei.com

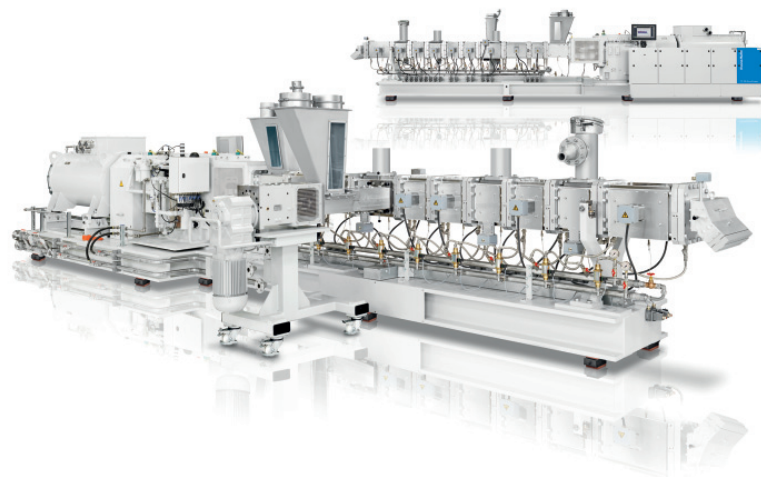

In many plastics processing industry sectors, the production-related integration of granulation technology in injection moulding, extrusion, blow moulding and thermoforming lines is advancing rapidly. The granulator manufacturer Getecha responded to this trend at an early stage and now equips the hopper and infeed granulators of its "RotoSchneider" series with numerous intelligent functionalities according to Industry 4.0 criteria. Managing director Burkhard Vogel explains in an interview what is important

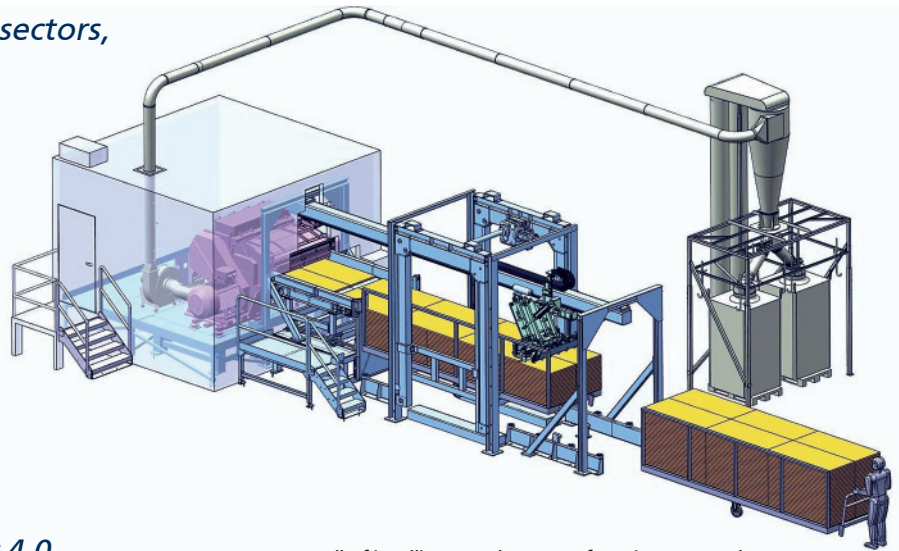

Full of intelligent Industry 4.0 functions: Complex system solutions for automated granulation technology. The picture shows a schematic view of a Getecha plant for grinding PP sheets with an infeed device, a gripper, an exhaust air system and a packaging system

“Digitisation Creates High Transparency”

Getecha Managing Director Burkhard Vogel about Industry 4.0 in Granulating Technology

Mr. Vogel, how significant is the equipping of Getecha granulators with Industry 4.0 functions currently for your development engineers?

Burkhard Vogel: In addition to the continuous innovation process for optimising the central performance components for the rotors, the cut-

ting chamber as well as the infeed and discharge systems, the development of useful Industry 4.0 functions for our granulators has gained enormously in importance, especially in the last three to four years. This applies to the series with the small and compact beside the press granulator series as well as to the large central granulators and the infeed granulators.

What do you think is the decisive factor here?

Vogel: Whether you consider the automotive industry and its suppliers, the manufacture of packaging materials or the large sector of the consumer products - in all industries the desire for further automation is pushing the digitalisation of production processes. The realisation of structures according to the standards of Industry 4.0 does not stop at the fields of ma-

Getecha Managing Director Burkhard Vogel



terial conditioning and granulation technology. Our engineers recognised this several years ago, so that we have already been able to build up a considerable know-how in this area and are now able to equip our RotoSchneider granulators with a range of intelligent information and communication features.

Are these Industry 4.0 functionalities meanwhile parts of the standard equipment of granulators?

Vogel: Not in all cases. Industry 4.0 functionality only gets into the focus of a customer when he wants to integrate granulation technology into

Everything at a glance: Control panel with touch screen on a Getecha granulator with integrated infeed and discharge technology



his mainly automated processes of plastics processing. When this occurs, the information and communication technology integration of the granulators into the production technology infrastructure plays a central role, so that their efficiency and availability can also be secured on a digital level.

Can you be more specific about this aspect?

Vogel: Imagine a plastics processor with the intention of integrating one or even several of our central or beside-the-press granulators into his material flow and automated production processes using conveyor belts, tilting devices, filling stations and other peripheral systems, in order to return residues and waste to production via a recycling circuit in a resource-saving manner. As part of such a project, various Industry 4.0 features in our granulators can provide valuable services. This is because it not only supports continuous system optimisation, but also serves quality assurance, allows process-accompanying monitoring and can significantly improve the availability of a production line.

Which Industry 4.0 functions should a granulator be equipped with in any case?

Vogel: This is decided based on the concrete requirements of a project and the customer's goals. Many things are now feasible because we use numer-

ous possibilities of modern sensor and interface technology as well as a range of established field bus systems. In this way many important process and machine data can be tapped, documented, processed, visualised and evaluated.

Do you have an illustrative example of this?

Vogel: If the signal exchange between granulator and production line is configured, all statuses, actions and error events can be recorded and assigned. Based on this, critical situations can be reported with defined warning levels to the higher-level production control system, which then initiates suitable counter and corrective measures at an early stage. In addition, it is possible to record all production-relevant performance parameters and material key figures of a granulator - such as throughput or the quality of the ground material - and to send them to the Operating Data Acquisition or Major Diagnostic Category systems of the plastics processor for further evaluation. This also applies to the runtimes, energy consumption, performance peaks and many other parameters from the operation of the granulators. We can also arrange for all system messages to be communicated to the host computer and archived there for analysis and documentation. All this creates maximum transparency about the performance of an automated system.

So the plant operator also receives data on the implementation of important process and quality improvements?

Vogel: Correct. Not least because part of the data material processed via the signal exchange between the production line and the granulating plant is also available for Industry 4.0 functions, which enable a so-called Predictive Monitoring and increase the plant availability. For example, much of the collected information can be prepared for predictive maintenance and then retrieved by the Getecha remote maintenance tool. For this purpose, the granulators can be linked and integrated into the customer's MRO infrastructure. The knowledge gained from this also flows into the troubleshooting catalogue of the integrated "manual" of the Getecha granulators. The master control system of the production machine can then display this information to the operator.

What specific industry 4.0 projects is Getecha currently working on?

Vogel: Well, these are ongoing projects with customers, and I cannot reveal too much about them. But I can tell you that whether it is about the waste from the extrusion of thick polypropylene sheets, faulty parts from the thermoforming of coffee capsules or edge trims from film production - in many places Getecha granulators with Industry 4.0 functions are now an established part of production lines. Digitalisation - in addition to the selection of the appropriate rotors, drives, hoppers and many other components - is now a major factor in the customer-oriented design of our granulators. And we firmly expect that this topic will continue to gain in importance in the future.

Mr. Vogel, thank you for this interview.

Getecha's energy consumption tool enables efficiency monitoring and performance optimisation of grinding plants (All images: Getecha)

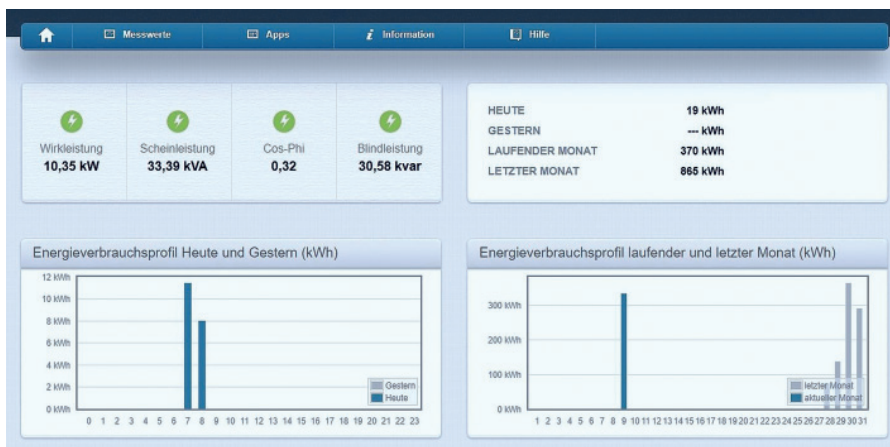

Getecha GmbH
Am Gemeindegarten 13,
63741 Aschaffenburg, Germany
www.getecha.de

Since 100 years the name KAMPF has been known for innovative slitting and winding technology. For customers all over the world machines "Made by KAMPF" mean reliability, quality and productivity. The company is very proud of this

Interdisciplinary teams developed the integrative platform the@vanced



From Pioneer to World Market Leader

100 Years of Focus on Innovation

When on October 2, 1920 Erwin Kampf with pioneering spirit starts to build slitter rewinders and winders for a wide range of web materials of the highest quality, he can hardly imagine that KAMPF – 100 years later – is the world market leader in this field.

KAMPF, since 1988 a wholly owned subsidiary of Jagenberg AG, headquartered in Krefeld, Germany, is today extremely successfully positioned with locations in Germany, subsidiaries in the USA, China and India, service branches and a worldwide network of representatives.

The modern PrimeSlitter in new machine design

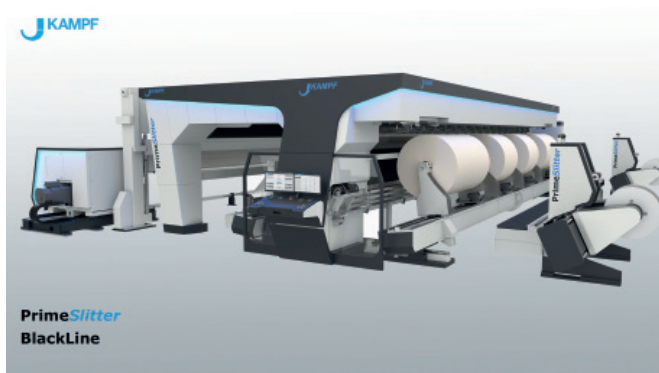

The headquarters of Kampf Schneid- und Wickeltechnik GmbH & Co



The extensive KAMPF portfolio includes slitting and winding machines, winders and special machines for the production and processing of web-shaped plastic films, composite materials, refined papers and technical films.

KAMPF also offers numerous solutions for processing new materials used in lithium-ion batteries. The company's classics include slitter rewinders and winders for up to eleven meters working width and production speeds of up to 1,500 meters per minute.

KAMPF, as the world's largest manufacturer in this segment, always faces the challenges of the markets and works continuously on the further development of its product portfolio. The two KAMPF Technical Centers can be used for tests with customer material as well as for numerous test series and developments under laboratory conditions.

In addition to new machine developments, customers benefit from the KAMPF Lifecycle Service. The experts of this worldwide service network are on duty around the clock and also offer numerous services, such as the KAMPF Academy with its comprehensive qualification measures.

However, the KAMPF anniversary year is a special year – it could have been so wonderful if the company, and the rest of the world, had not faced the SARS-CoV2 with enormous challenges. Although KAMPF had a relatively mild “corona” course and the crisis management has been successful so far, thanks to different working time models, a much higher use of digital technology and with the help of KSP (KAMPF Service Portal), the planned celebrations had to be cancelled completely.

What can we expect in the future?

KAMPF is facing further challenging tasks and is already intensively engaged in the topics of modularization, automation and digitalization. With “the@vanced”, KAMPF is developing a leading, integrative platform for networking machines and components along the value chain. KAMPF is also co-founder of the Converting 4.0 network,

The “Converting 4.0” network now counts more than 80 participating companies and associations



Installation at the Wiehler site

which connects people and forward-looking industries. The network now counts more than 80 participating companies and associations. The new technical departments “Automation” and “Industry 4.0” are supporting the transformation from a machine manufacturer to a system provider.

100 years of company history show that, in addition to courage, the competence and enthusiasm of the employees is the central success factor of the machine manufacturer. Therefore, KAMPF focuses on sustainable human resources development and the promotion of young talents. Training and the most modern teaching methods have always been a priority at KAMPF. The company is involved in support and early education measures through learning partnerships with several schools in order to inspire children and young people for the so-called MINT professions (mathematics, computer science, natural science and technology) and to give them an insight into the working world of mechanical engineering.

100 years of company history – for KAMPF both incentive and challenge. Because in today's networked and digitalized world, the demands placed on man and machine are changing rapidly. KAMPF is ideally positioned for this and will continue to develop new technologies and modern solutions for ever new challenges with expertise and passion. At KAMPF we always face change with courage and curiosity.

Clever Use of Defects – Integrated Quality and Production Monitoring

*OCS Web Inspection System
(FSP600) – Installed OCS
camera in film line*



For more than two decades now, the intensive partnership between Mondi and OCS has been cultivated for the benefit of both parties. OCS and the global Mondi Group have concluded a cooperation agreement and work on further developments has been ongoing in a continuous exchange at the management level. Mondi is a leading packaging and paper group and the plant in Gronau, Germany specialises in hygiene components, advanced technical films, label films, as well as decorative and flooring films. Mondi Gronau sees itself as a pioneer in the field of integrated process analysis and integration in film extrusion



OCS Web Inspection System (FSP600) – Process integrated control unit

Integrated Quality and Production Monitoring – Timely Prevention of Variations in Quality

From the technology for quality and production control to the self-controlling machine, Mondi already implements this with the help of OCS

OCS Pellet Scanner (PS800C) – Detects impurities in highly transparent and opaque pellets

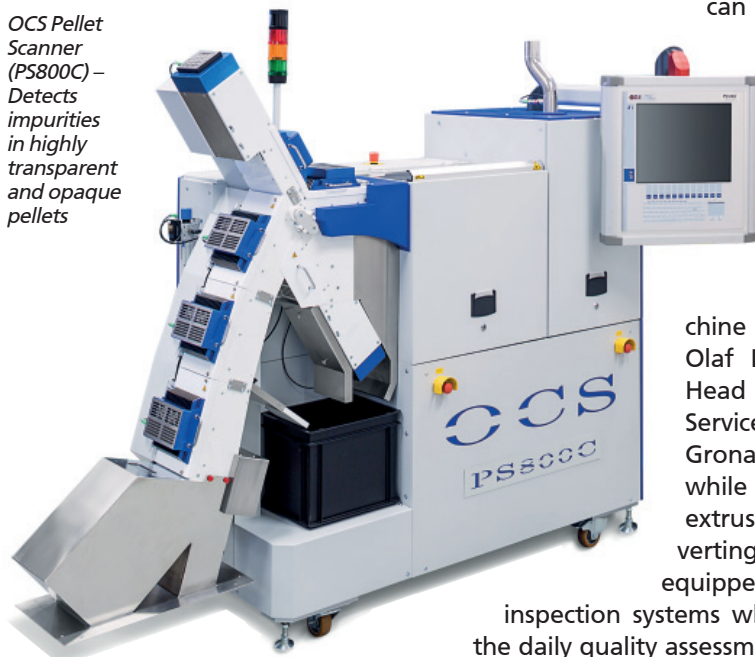

OCS Laboratory Extrusion Line – Detects optical errors in extruded films and measures for example haze, gloss, film thickness, etc.

components. The basis is provided by the sophisticated inspection technology using the OCS Web Inspection System FSP600, which detects and marks defects and immediately alarms the operator. However, a simple and user-friendly teach-in software is also essential. Defects are detected and classified accordingly. Mondi Gronau sees itself as a pioneer in the field of holistic process analysis and integration in film extrusion. “OCS Inspection Systems provide the basis for our process control. By means of the extended networking of complete data stocks from the OCS analysis software and our PDA system, we can react faster

to quality variations and assist in the reduction of scrap, rework and machine downtimes, Olaf Brauckmann, Head of Technical Service at Mondi Gronau.” Meanwhile almost all extrusion and converting lines are equipped with OCS inspection systems which support the daily quality assessment. The machine operator is informed about process variations in good time and can counteract quality changes. All inspection systems have an interface to the company’s internal production data acquisition system (PDA), so that each reel change is automatically stored with the respective roll number. The complete traceability is given and supports the acquisition of information. Film rolls can be automatically locked by the system without operator intervention. This is made possible by additional analysis software, which relates material, raw material and process parameters from the PDA system to the respective quality/film grade and leads to long-term statistical process control.

Further use of OCS systems in the production process:

- Raw materials will be inspected “inline” by an OCS Pellet Scanner (PS800C)
- Compounds will be analysed “of-line” by OCS Laboratory Extrusion Lines.

OCS Optical Control Systems GmbH
Wullener Feld 24, 58454 Witten, Germany
www.ocsgmbh.com

Mondi Gronau GmbH
Jobkesweg 11, 48599, Gronau, Germany
www.mondigroup.com

At the moment, the market situation is quite difficult, not only in Europe, but also all over the world. Due to the coronavirus epidemic, lockdowns of entire economies lead to the fact that markets practically do not grow in volume, and often stagnate or even decrease. Therefore, the main strategy is to trust the customer to the quality of the products at a competitive price.

That's why a few years ago, A-Len d.o.o., located in Koper, Slovenia, entered the European market with the goal of providing polymer processors with solutions aimed at optimizing the price-quality ratio of masterbatches



Survival Recipe for the Market of Polymer Products –

“The Best Apple from the Best Apple Trees”

Of course, in the industry of polymer products, the main components of the cost of the final product are the price of the main raw material – polymer, as well as the cost of processing. However, within the same region, these two components are usually the same for everyone. Therefore, it is necessary to find the other variants to reduce the cost of the product and increase the margin of the business.

It is known that the polymers like polypropylene or polyethylene as they are, almost never have the properties and features which allow getting the end product of a pure polymer only. All products must have a targeted geometric shape, a certain strength, and most of the products must have some color. Accordingly, various additives – masterbatches – are required for processing polymers, and the content of some of them in

the end product can reach 50 to 60%.

Masterbatches are mostly quite expensive, but they directly affect the quality. Therefore, optimization of their application is a primary task to reduce the cost of products and to adjust the financial side of a polymer production generally.

There are a lot of types of masterbatches for polymers, depending on their functions in plastic processing. One also knows that there are a huge number of masterbatch manufacturers all over the world.

Some of them can produce any masterbatches, all possible types. The own experience of A-Len company and of their customers in different countries shows that all types of masterbatches at an adequate price cannot be equally good being made by the same manufacturer. The most manufacturers are highly specialized and produce only one or, at best, 2 to 3 types of masterbatches. They make these masterbatches very professionally, at a high level and are able to produce it cheaply. But then, if the production needs several types of masterbatches (and this is almost always the case), then the task is to collect completely different types of masterbatches from many suppliers, and this often does not have enough time, efforts, and other resources.

For example: we buy a UV stabilizer from a company that produces only HALS – the active substance of the UV stabilizer – and accounts for 30 % of the world's output. This company produces a ready-made masterbatch for us using its own HALS. The same is with the dessicant masterbatch: our supplier is a company, which produces only this type of masterbatch and nothing more. Our filler masterbatch is manufactured by a company that has its own chalk pits as well as the workshops for anti-abrasive calcite treatment, and also has production facilities located near ports for optimal logistics, which price plays a major role in the cost of this type of masterbatch. Thus, each brand of A-Len masterbatch is backed by a successful professional manufac-

turer, which, as a rule, has been specializing in the production of only this type of product for many years.

Taking into consideration our sales volume – more than 1,500 tons of various masterbatches per month – we get low prices for masterbatches from suppliers, as well as the best rates from container lines and road carriers. All this allows to offer high quality at an attractive price. According to Chinese wisdom, Aleko collects "the best apples from the best apple trees" and respectfully offers a basket with these apples to the customers.

A-Len d.o.o.
www.a-len.eu

A-Len® SUPERMARKET OF MASTERBATCHES



€3500/MT

UV-stabilizer masterbatch

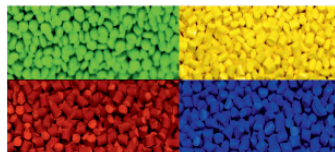

FROM €1990/MT

*Color masterbatches
Up to 70 shades*



€2,090/MT

*White masterbatch
70% TiO₂ + 0% CaCO₃*

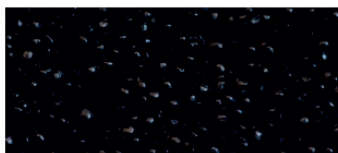

€1,190/MT

*Black masterbatch
40% C/B + 0% CaCO₃*



€429/MT

*Filler masterbatches
80% CaCO₃ +
LLDPE & Additives*



€790/MT

Dessicant masterbatch

ALL PRICES EXW KOPER, SLOVENIA

+386 31 301 615

sales@a-len.eu

www.a-len.eu

Oculavis SHARE – Remote Maintenance with Augmented Reality

Not only in times when visits to customers are suspended out of concern for the health of employees, but also for efficiently addressing a variety of small, quickly solvable challenges at the compounding line, FEDDEM GmbH & Co. KG will in future offer remote maintenance support via a smartphone app

To support customers in the maintenance of extrusion lines, the machinery builder will in future rely on Oculavis SHARE software for effective communication. The use of this browser- and cloud-based software complies with state-of-the-art security standards and enables the customer to network with a FEDDEM service technician for identifying and eliminating errors in the short-

*Image annotation at FEDDEM's service centre
(All Photos: FEDDEM)*



The customer can also use an application app on a smartphone or tablet for image-based communication

est possible time. The way it works is simple: open the app, start the video call and off you go. The networked software generates an encrypted connection. The HD video as well as audio transmission allow you to follow the technician's step-by-step instructions directly.

For more complex actions at the installation, powerful data glasses can be employed, which allow the partner on site to carry out work with both hands without disrupting the communication flow. Various functions, such as machine and sensor connections as well as superimposed documents or documentation, allow for a comprehensive solution for digital remote maintenance with the aid of augmented reality.

"We are currently still in the implementation phase", says Klaus Hojer, Business Development

Manager at FEDDEM. "It is already becoming apparent that the customer does not necessarily have to use special glasses for imaging communication, but that it will also work well in the short term via an application app on a customer's smartphone or tablet". Initial experience has already been gained with a FEDDEM LFT system that had already been commissioned. In a dialogue, the customer received further, practical information on changing the settings of the system for processing a modified product with online guidance by a FEDDEM technician. According to FEDDEM, it is also possible to communicate via annotated still images if a customer is concerned about the confidentiality of his production environment.

Direct operator guidance by means of data glasses via augmented reality projections



FEDDEM GmbH & Co. KG
Mosaikweg 19, 53489 Sinzig, Germany
www.feddem.com

New Pump Series and Retrofit Kits for Frequent Product Changes

MAAG Group is launching the new FQ series/kit for the existing pump portfolio. Another revolutionary and innovative pump version in the industrial product portfolio, the 'FQ' keeps up with the new-age fast paced production processes, lifting the capabilities of the external gear pumps to ease the extreme needs of the customer and the industry, like never before

This FQ – 'quick cleaning' version is being released for the production facilities with a constant need to clean and wash the transfer line at the end of each production batch, different colours, different additives etc.

The pump can be disassembled at the quickest without needing to dismantle the drive shaft from the drive motor and the seal.

This feature can be applied also on the existing pump series – CX, TX, FX, DX by using the FQ kit or the pump can be selected as a FQ model itself.

The FQ can change the production and maintenance style of the customers without compromising on the desired operating characteristics.

The FQ kit provides high flexibility and functionality with easy maintenance and part replacement possibilities.

MAAG Groups FQ – 'quick cleaning' version has been developed especially for production lines where product lines at the end of each production batch to are to be cleaned and sanitized

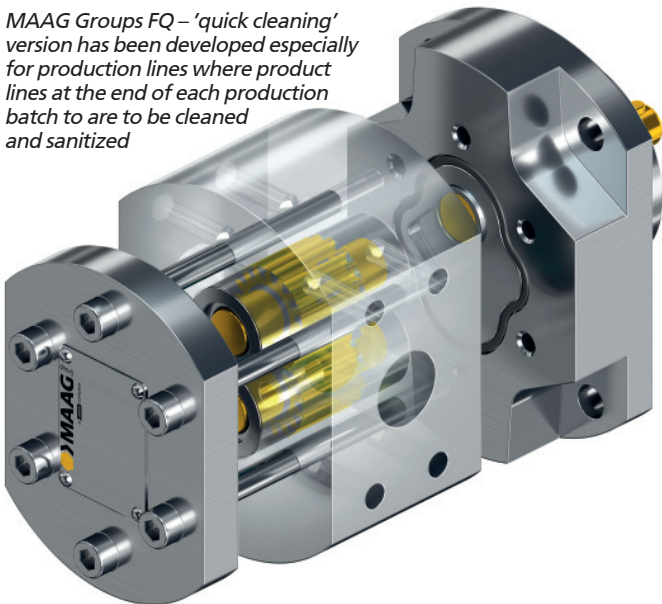

New FQ pump of MAAG Group

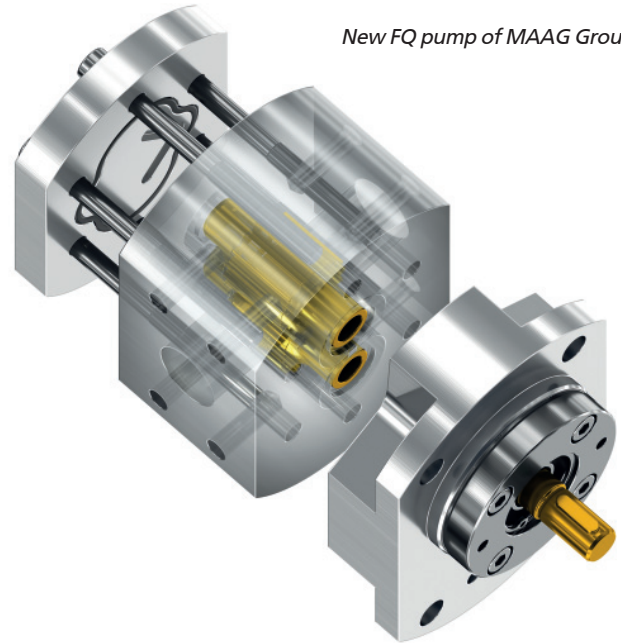

Moreover, to accommodate varied range of process fluids and flow rates, the seal flange can accommodate different pump sizes, for example, the DX 20 can be converted to DX 20/10 or 20/5 and FX 22 can be converted to FX 22/14 or FX 20/8. In this way, the drive configuration and seal flange can be retained and there can be a possibility to have variations in flow rate depending on the size of the pump that will be installed.

The FQ pump is currently available for the following sizes:

- DX 20/20 - 20/10 - 20/5
- FX 45 - 36 - 28 - 22 - 22/14 - 22/8
- CX/TX 45 - 36 - 28 - 22

Since the FQ version is unique, the feature is protected by the patent.

Maag Pump Systems AG
 Aspstr. 12, 8154 Oberglatt, Switzerland
www.maag.com
<https://maag.com/de/pump/flexinox/>

The 8th IPTF-2020 – International Polymer Technology Forum – taking place in Saint Petersburg from September 22 through September 23 has been brought to a successful conclusion. Though the situation in the world is highly affected by the COVID-19 pandemic and remains quite unsettling, the Forum was able to unite 210 participants representing both Russian and foreign companies. Despite some amendments resulted from the closed borders – some papers were presented remotely via Skype –, the forum was no less efficient than in earlier years



Yury Taperov, AtlasMash

International Polymer Technology Forum Successfully Finished

Unparalleled anti-contagious measures had been undertaken to protect the forum guests: the room was provided with a supply and exhaust ventilation system; the participants were seated sparsely with consideration of the social distance; protective masks and antiseptics were offered at the entrance; the room, furniture, and microphones were sanitized regularly. As in the previous year, certain Forum stages were implemented in parallel in two different sections.

This year such eminent companies as 3M, Moretto, and Erema were among the conference sponsors. Alexander Boyko (NCPack) shared the latest trends in the polymer packing market. Konstantin Vernigorov (SIBUR) and Dmitry Kositsky (BARS-2) presented their new branded products.

The second section was devoted to the domestic raw-material base. The reported papers were very interesting for rep-

Alexey Fedotov, Moretto

resentatives of all the polymer industry branches. Artyom Kasin and Anna Lee (Himstab) told the attendees about using calcium stearates as lubricating and stabilizing additives, Rusplast representatives shared their ideas about TEP as a preferable alternative to PVC, Svetlana Khashirova, Head of the Organic Chemistry and High-Molecular Compounds Department of KBSU, presented her paper Superengineering Polymers and Composites for 3D Printing.

Later the conference was continued in two parallel sections, one of them was devoted to extrusion and the other to injection molding. Andrey Volkov (Coperion) presented a paper on the options for the efficient operation of turn-screw extruders with unidirectional rotation in various polymer processing industries. Reifenhäuser introduced unique solutions for the cyclic economy. Alexey Chernykh (OCS) told about the innovative quality control tools for film production. Lola Ogrel, a specialist from the TEC Analytical Centre, shared her data about the plastics processing problems in Russia, as well as about certain issues of the extrusion equipment market.

On day two, the extrusion subject passed to the recycling section. Yury



*Alexander Petrov, Functional Materials
(Group of companies)*

Taperov from AtlasMash told the story of substituting shredders for crushers. The remote report of Elena Lyai (Herbold Meckesheim) was dedicated to the company's new recycling solutions. Another online paper was about domestic waste recycling for the food industry needs (Kaloyan Iliev, EREMA, Russia).

The IPTF 2020 was finalized with the digitalization and smart periphery session. Moretto, Irbistech, and Polymerphys Rus shared their novelties and best practices. Artura Gimadeyeva (Irbistech) demonstrated dry ice and its properties during the presentation on applying cryogenic blasters for removing remaining polymers from equipment.

The next IPTF 2021 will take place at May 25-26 in Saint Petersburg.

redaktion@vm-verlag.com



PLAST[®] IMAGEN

LIGHT

MEXICO 2021
MARCH 9-11

Centro Citibanamex / Mexico City

UNLIMITED OPPORTUNITIES, THE BEST WAY TO START A YEAR IS BY DOING BUSINESS

PLASTIMAGEN[®] LIGHT 2021, is a premier event that will pave the way towards the reopening and future growth of the economy. Is the international business exhibition dedicated to the plastics industry in Latin America. **PLASTIMAGEN[®] LIGHT** offers everything your business needs in terms of new business strategies, action plans, and solutions for the challenges faced by today's ever-changing global market.

Solutions for a circular economy



Promote
recycling and
standardization
infrastructures

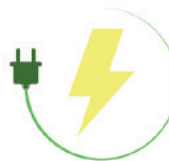

Reduce, reuse
post consumer
content



Design to
recycle and
reuse

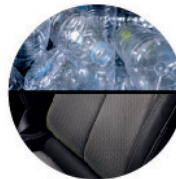

Biobased,
degradable,
compostable

ADVANCED TECHNOLOGY TO TRANSFORM YOUR PRODUCT

PLASTIMAGEN[®] LIGHT is the most complete and important plastic exhibition in Latin America to meet the needs of industries looking for sustainable solutions.

FREE ONLINE registration

PLASTIMAGEN | Plastimagen | @plastimagen | plastimagenmx

www.plastimagen.com.mx

Organized by:



Supported by:



Member of:



Certified by:



Venue:



Sponsor Registration



Silver Sponsors



The 34th International Exhibition on Plastics and Rubber Industries

New Era. New Potential. Innovation for Sustainability

2021.4.13-16

Shenzhen World Exhibition & Convention Center, PR China

Pre-register for
Admission Discount



- 350,000 sqm Exhibition Area
- 3,600+ International Exhibitors
- 3,800+ Machine Exhibits
- 90,000 sqm Plastics & Rubber Raw Materials Zone



www.ChinaplasOnline.com



Hong Kong (852) 2811 8897 | Singapore (65) 3157 3101

China: Chinaplas.PR@adsale.com.hk | www.adsale.com.hk | (852) 9602 5262

ORGANIZER



CO-ORGANIZER



SPONSOR



OFFICIAL PUBLICATIONS & ONLINE MEDIA

