

01/2019

VVA VERLAG
Cologne /Germany



EXTRUSION INTERNATIONAL

USA

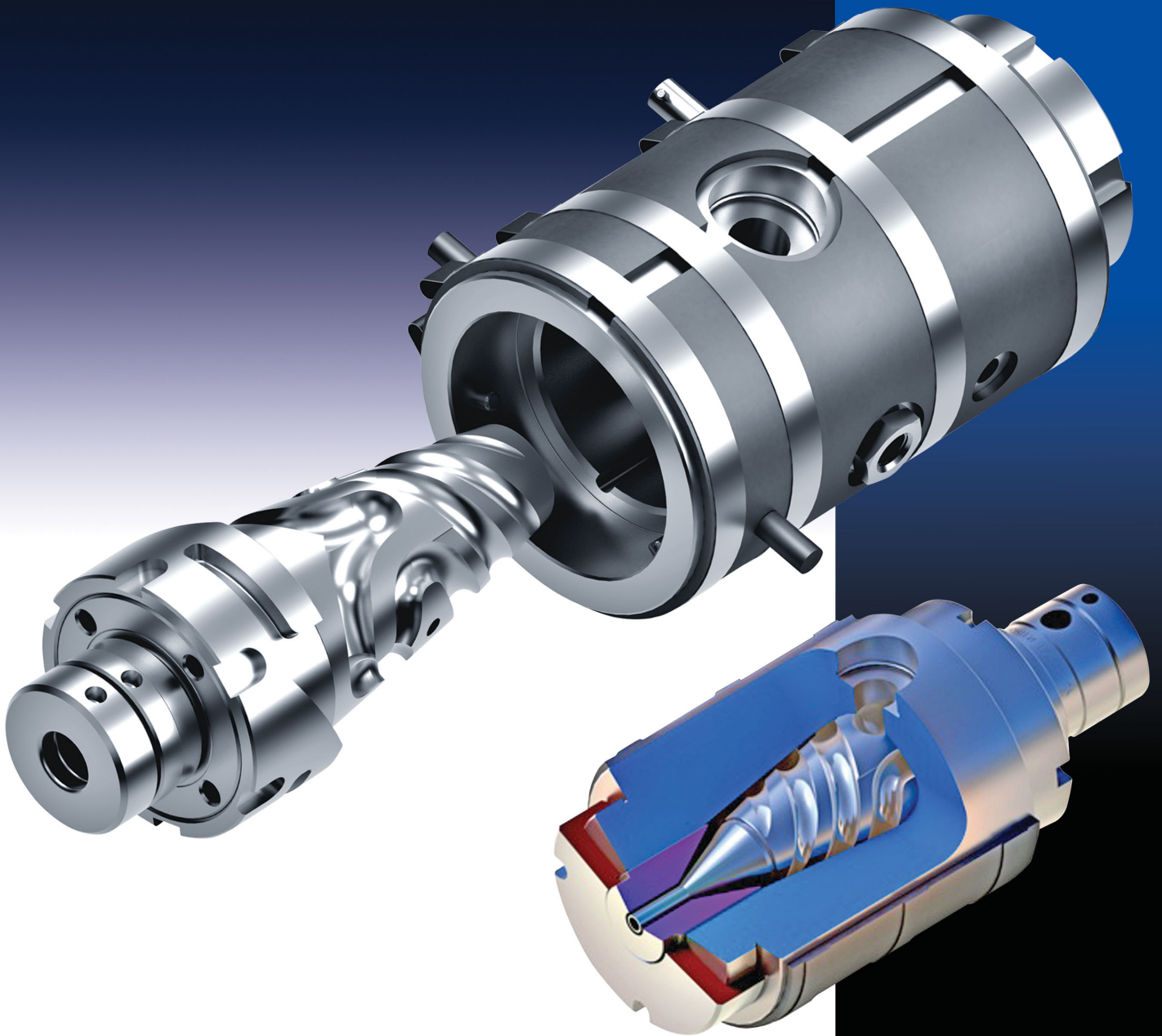

Guill
EXTRUSION TOOLING

BULLET II



Recycling problems? Not any more!



"PCL" separation combination: feeder (right), blade unit (centre) with several replaceable cutting blades, haul-off unit (left). The caterpillar pairs are fitted with standard pads like the ones generally used in profile production.

You know the problem. Cassettes of window profiles pile up with sharpened sealing lips or co-extruded top layers since recycling of this material bond has previously been very complex.

"PCL" non-cutting separation combination for unmixed RECYCLING of window profiles

This new STEIN machine generation solves the problem by moving the profile past specifically arranged stationary blades and cutting off the undesirable material components in the process. A pre-set blade block is locked in place for each profile type in order to reduce the set-up time.

You ultimately get an unmixed profile that constitutes about 80% of the original extrudate and can be 100% fed back into the production process after grinding.

Another new
and patented
innovation!

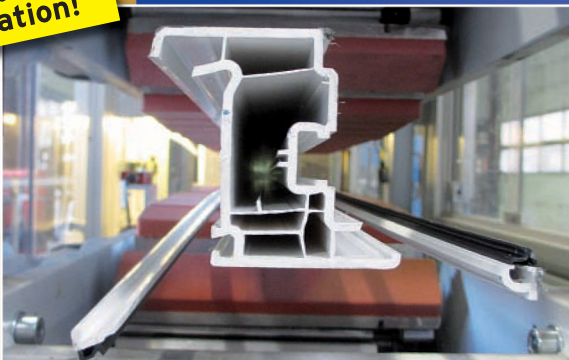

This new STEIN machine is easy on resources, saves material, storage costs and time-consuming sawing of window profiles and speeds up recycling.

A detailed description is available on request. You will be impressed with the functionality!

The non-cutting separated parts on the left and right stand out. The centre picture shows the unmixed profile that can be fed back into the production process.

in Extrusion

RAZ and RAZR caterpillar haul-off unit (pivoted)

The STEIN caterpillar haul-off units are suitable for removing a very wide variety of profiles with horizontal pads or high pads. The new patented **PIVOTED RAZR caterpillar haul-off unit**, first exhibited at the 2013 K Trade Fair, is continuously adjustable from 0-90 degrees, does not need any form pads and makes fast profile change possible.

The function of the caterpillar haul-off units with their innovative details:

- ✓ The pre-stretched double chains do not prevent any other elongation during operation. The chains are supported by high-molecular anti-friction material that can be easily changed.
- ✓ The lower caterpillar guide is permanently connected to the machine base. The upper caterpillar can be guided sturdily upwards on the infeed and discharge sides. The contact pressure is ensured by a precision controller with adjustment of the back pressure to relieve weight.
- ✓ The innovative **TILT LOCK** is designed to be supported on the next pad part, thus preventing tilting even with high pads. They can be quickly replaced via a quick-release lock.
- ✓ The caterpillar haul-off unit can be pivoted 90 degrees so that the upright extruded profile on the even surface can be removed. There is thus no need to change the pads (see image on right).
- ✓ The specific drive concept provides optimal **anti-slip control** that minimises wear and tear of pads even when critical profiles are used. No need to worry any more about pad imprints. This type of control guarantees optimum production conditions since both caterpillar speeds align.

STEIN MASCHINENBAU arrived in the future long ago! Use this innovation to give you a competitive edge.

„STEIN BLUE-LINE - for a sustainable future“ stands for sustainable and energy-efficient equipment. Nearly 100% domestic production and high vertical integration guarantee maximum demand.



Pivoted RAZR caterpillar haul-off unit

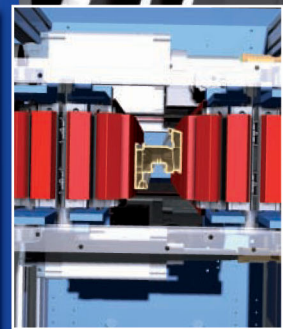

Pad with tilt lock



STEIN

Maschinenbau GmbH & Co. KG

Wartbachstr. 9 · D-66999 Hinterweidenthal/Germany
Tel. +49/63 96/92 15-0, Fax +49/63 96/92 15-25
stein@stein-maschinenbau.de · www.stein-maschinenbau.de



Made in
Germany

Firms in this issue	6	Davis-Standard: Equipment and Services tailored to Exact Needs	42
Imprint	7	Kampf LSF: New Film Converting Plant	42
Industry News	8	Dr. Collin: Pilot and Laboratory Lines for the Plastic Processing Industry	43
Calendar	8	Mahlo: Quality Control Systems	43
Industry News USA	30	Extrusion Tooling	
Biopolymer Films Market Value	30	„THE BULLET II“ Extrusion Head	44
Expansion of OPP Film Manufacturing	30	Industry 4.0	
Free Trainings Seminars at Compounding World Expo	31	Industry 4.0 Solutions for Compounding Extruders	45
Latest Highlights at PLASTECH WEST	31	Recycling – Case Study	
Blow Molding: Partnership announced	32	With the Right Choice to Success	46
2019 with Record Sales started	32	Testing Technology	
North America Masterbatch Market	33	Service over the course of the entire instruments' lifetime	50
First Quarter R&D Additions announced	33	Materials	
ICE Europe 2019	34	Launch of high active magnesium oxide production	53
Derichs: „High-Voltage“ Development	35	Materials, Recycling	
Kündig: Filmtest 3G – Offline Quality Control for Films	36	Products made with Chemically Recycled Plastics	54
Erhardt+Leimer: New edge sensor with extra wide measuring range	37	Drive Technology – Inspired by Sports	
Goebel IMS: Tailor-made Machine Concepts for Demanding Applications	38	The Benefits of Intelligent Acceleration Technology in Electric Drives	56
SML: Lamination Lines for Aseptic Packaging	38	Lamination Films	
Eltex: Innovative Electrostatic Systems for Process Optimization	39	New Tailored Blank Laminating Technology (TBL) – intelligently automated	58
Nepata: Film Separators for Faulty Self-Adhesive Films	40	Packaging	
Fraunhofer IAP: Much more than plastics	41	Liner Films for Flexible Intermediate Bulk Containers	60
Fraunhofer FEP: Evolution of Surface and Light	41	Measurement Technology	
Fraunhofer IGB: Innovations at Interfaces	41	New Barrier Layer (EVOH) Inline Thickness Measuring Device introduced	62
Emmendinger: When Power meets Precision	41		
Dienes: The Perfect Slit	42		
BST Eltromat: Quality Assurance Systems	42		



Cover

Extrusion Tooling... on the Leading Edge of Technology

Guill is the Leading Extrusion Tooling Designer & Manufacturer with over 50 years of experience. The engineers design custom plastic, rubber and TPE extrusion tooling using the latest technology. In addition, the company draw on their years of experience to help the customer develop solutions that increase efficiency and decrease the production cost, resulting in an excellent end product.

More on page 44

Guill Tool & Engineering
 10 Pike Street, West Warwick, RI 02893, USA
www.guill.com



54 BASF is breaking new ground in plastic waste recycling with its ChemCycling project.

Recycling of plastic products requires specialization to be efficient. Accordingly, the Dutch company DALY Plastics has dedicated itself entirely to the recycling of agricultural films and packaging films from transport logistics. DALY Plastics relies on the machine technology of MAS.

46



With its 5-Star Service, Brabender strives to keep downtimes as short as possible and the customers' operating costs low. The German lab equipment manufacturer is offering a number of additional benefits in the category of "Value-Added Services". **50**

From 12 - 14 March 2019, the converting industry will gather for the 11th edition of ICE Europe, the World's Leading Exhibition for Paper, Film & Foil Converting, at the Munich Trade Fair Centre in Germany. **34**



Index of Advertisers, companies and *fairs* referred in this issue

ADSALE	11	Kampf LSF	42
Amaplast	18	Kiefel	25, 58
AMUT	15, 25	KOCH-Technik	16
BASCO	13	KraussMaffei Berstorff	45
BASF	16, 54	Kündig Control	36
Borealis	23	Mack Brooks	34
Brabender	50	Macro Engineering & Techn.	32
BST Eltromat	42, 43	Mahlo	43
Chinaplas 2019	11	MAS	46
Clariant	19, 26	Mondi	60
Colines	28	Moretto	20, 31
Collin, Dr.	43	motan-colortronic	21
Compounding World Expo.....	31	Nepata	40
DALY	46	NGR	22
Davis-Standard	14, 33, 42	PlasMec	15
Derichs	35	PlasticsEurope	13
Dienes	42	Plastimagen 2019	08, Inside Back Cover
Erge	19	pmh	29
Eltex	39	R&B Plastics Machinery	32
Emmendinger	41	RIGK	20
EREMA	29	RMCC	53
Erhardt+Leimer	37	SBI Produktion techn.	62
European Bioplastics	14	Secor	32
Fraunhofer IAP	41	SIKA Machinery	32
Fraunhofer FEP	41	Songwon	22
Fraunhofer IGB	41	SML	38
Global Market Insights	30, 33	SPE	21
Global Recycling Found.	13	Starlinger	24
Goebel IMS	27, 38	Stein Maschinenbau	Inside Front Cover+3
Guill	13, 24, 44, Front Cover	Troester	23
ICE Europe 2019	34	Uth	26
ILLIG	47	Weber, Hans	9+10
IPTF 2019	Outside Back Cover	Windmüller & Hölscher	28
Jwell	7	Zumbach	17, 27
Kabel.Consult.Ing.	56		

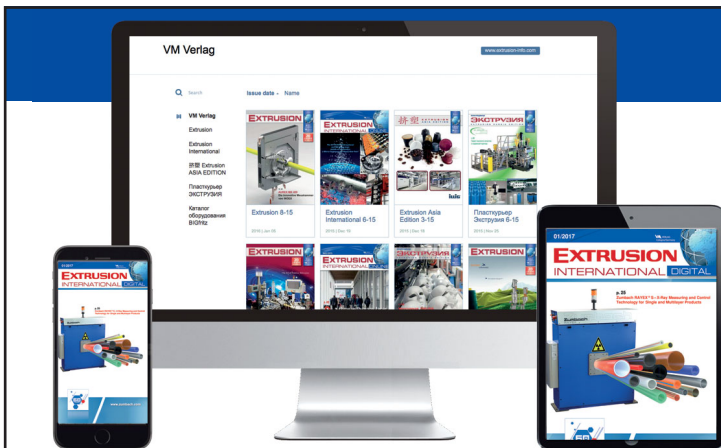

**Subscribe
for a year
free of charge!**

Annual subscription to the digital magazine

Extrusion International

- **Free of charge**
- **Just** leave your **e-mail address**. No spam. Your data is safe
- Get **immediate notifications** when new issues are published and read online

www.plastic.expert



The Extrusion International Digital/Print Magazine is published bimonthly by VM Verlag GmbH. P.O.Box 501812, D- 50879 Cologne, Germany

EDITORS

Bettina Jopp-Witt (Editor-in-chief)
Tel. +49 221 546 1539
redaktion@vm-verlag.com

Alla Kravets
Tel. +49 2233 949 8793
a.kravets@vm-verlag.com

ADVERTISING SALES

Martina Lerner
Tel.:+49 6226 971515
lerner-media@t-online.de

ADMINISTRATION

Alla Kravets
Tel. +49 2233 949 8793
a.kravets@vm-verlag.com

PRINTING

h-mailconcept e.K.
directmarketing
Venloer Str. 1271, Cologne, Germany

SALES REPRESENTATIVES

Quaini Pubblicita (Milano IT)
Tel. +39 02 39216180
grquaini@tin.it

Worldwide Services Co., Ltd.,
(TAIWAN)
Tel. +886-4-2325-1784
global@acw.com.tw

Tokyo PR Inc. (Japan)
Tel. +81 (3) 3273-2731
extrusion@tokyopr.co.jp

Reprints, Translation etc

No part of this publication may be reproduced, stored in a retrieval system, or transmitted, in any form or by any means, electronic, mechanical, photographic, recording or otherwise, without prior permission of the publisher.

www.smart-extrusion.com



PP Honeycomb Board Extrusion Line

Double Wall Corrugated Pipe Extrusion Line

SPC Calcium-plastic Environmental Floor Extrusion Line

SHANGHAI JWELL MACHINERY CO.,LTD.
Add:No.111 Chun Yi Road,Jia Ding District., Shanghai
Tel: 86-21-69591818 69591111

www.jwell.cn
sales@jwell.cn



13th BioPlastics Market

12. - 13. 03. 2019

Bangkok / Thailand

Centre for Management Technology

www.cmtevents.com

ICE Europe 2019

12. - 14. 03. 2019

Munich / Germany

Mack Brooks Exhibition

www.ice-x.de

Recycling Expo 2019

01. - 02. 04. 2019

Paris / France

Conference series llc Ltd

<https://recyclingcongress.conferenceseries.com>

Plastimagen

02. - 05. 04. 2019

Mexico City / Mexico

www.plastimagen.com.mx

Tires & Rubber

23. - 26. 04. 2019

Moscow, Russia

www.rubber-expo.ru/en/

CHINAPLAS 2019

21. - 24. 05. 2019

Guangzhou / P.R. China

Adsale Exhibition Services Ltd.

www.ChinaplasOnline.com

Plastpol 2019

28. - 31. 05. 2019

Kielce / Poland

www.plastpol.com

Biobased Coatings Europe 2019

19. - 20. 06. 2019

Dusseldorf / Germany

Active Communications International

(ACI Europe)

www.wplgroup.com/aci/event/biobased-coatings-europe

PLASTIMAGEN® MÉXICO 2019

The most important event of the plastic industry in Latin America

■ The new edition of PLASTIMAGEN® MÉXICO (April, 2-5, Mexico City) organized by Tarsus México, will showcase all trends and new technologies from the plastic industry worldwide. PLASTIMAGEN® MÉXICO 2019 will display over 870 companies representing approximately 1,600 brands from more than 27 countries, 14 International Pavilions, and the ANIPAC Pavilion (the National Association of Plastic Industries in Mexico). With more than 45,000 m² of exhibition space, PLASTIMAGEN® MÉXICO is the most complete and foremost plastics expo in Latin America; an event designed to meet the needs of more than 30,000 visitors who are seeking innovative solutions for their companies. In its 22nd edition, PLASTIMAGEN® MÉXICO is Latin America's plastics sector's most important business center for closing deals, networking, exchange of ideas, technical training, research for innovations, products, solutions, and much more; displaying the latest in technology/machinery, and exhibiting products and services that are aimed to more industries.

This event will also feature a unique International Conference Program organized jointly by the National Association of Plastic Industries (ANIPAC) and Tarsus México, which will offer visitors an excellent option to train and find solutions to problems that arise in any link in the chain of the plastic industry.

In this edition, a new sector is highlighted that corresponds to Circular Economy on the ground floor of the site. For this and many other reasons, PLASTIMAGEN® MÉXICO 2019 is considered the most important exhibition of the plastics industry in Mexico and Latin America.

Plastic in numbers

Across the globe, the plastic industry generates sales for more than \$ 22 billion a year and its market value is \$ 33 billion. If we talk about Mexico only, the plastics industry is booming. In 2017, production increased by 7.7% annual growth and by the end of this year more than 6% is expected.

Mexico imports 20 billion dollars of resins and plastics a year and it is one of the main countries in the worlds to export products along with the United States and Canada. This is due to the increase use of plastic as a raw material in many industries as they see that is becoming more useful and has a lot of potential. Many companies have become more competitive by evaluating the option of replacing parts of traditional manufacture for those with plastic in industries such as: automotive, medical devices, construction, packaging, agricultural and household appliances, among many others.



➔ For more information:
www.plastimagen.com.mx



Extruder Technology



WPS3 – the brand new “cockpit” for WEBER extruders

More structured, more intuitive, simply better: Nearly all WEBER extruders now feature the WPS3 operating unit. This new development now makes controlling the systems even easier. The 21.5" touch screen with full HD resolution (16:9) and the modern smartphone display structure make operation of the extruder easier than ever before.



Scan Code and learn more about WPS3
extrudertechnologie.de/1/features/

Features

- // Operating system on Windows 7® basis
- // Intuitive operation
- // Key pads and wheel integrated into the panel for precise setting of target values
- // Graphic display of the machine on a full HD touch screen (16:9)
- // All relevant machine data at a glance
- // Integrated analysis functions
- // Integrated SQL server for data recording and web server (PHP) for data queries
- // Integrated interfaces CAN bus and X2X bus
- // Optional: Profibus, Powerlink and OPC
- // Remote query if an internet connection is available
- // Pre-heating of the machine using timer function

Hans Weber Maschinenfabrik GmbH
Bamberger Straße 20 · 96317 Kronach · Germany
Phone +49 9261 409-0 · Fax +49 9261 409-199
info@hansweber.de · www.hansweber.de

WEBER

CHINAPLAS 2019

to present a rich assortment of concurrent events

May 21-24, 2019,
Guangzhou, PR China

■ During the past year, the operating environment for most industries became increasingly complex. It is more vital than ever for enterprising businesses to anticipate key market trends, to understand the industrial structure with a global perspective, and to master technological innovation. CHINAPLAS 2019, with its aim to promote the plastics and rubber industries' development by focusing on technology and creativity, offers an international platform for the release and exchange of information related to advanced new technologies. The show will not only feature more than 3,500 exhibitors, but also will organize a series of exciting concurrent events to address those industries' needs.

"We saw that exhibitors and visitors not only seek to secure the supply and demand of key materials, equipment and services at CHINAPLAS, but they also actively discuss hot topics, and explore industry trends and opportunities," said Ada Leung, General Manager of Adsale Exhibition Services Ltd., the show organizer. "We showcase innovative products and cutting-edge solutions together with exhibitors who are industrial leaders of the world. In addition, the show features a number of concurrent events covering the circular economy, Industry 4.0, industrial design, medical plastics, and much more. With richer content, more diversified forms, and more practical solutions than ever, CHINAPLAS offers ways for upstream and downstream members of the supply chain to collaborate and create new opportunities for growth. We aim to empower the development of the plastics and rubber industries," Leung said.

"Design x Innovation", which comprises three parts: "CMF Inspiration Walls", "Design Forum" and "CHINAPLAS Designers' Night"



CHINAPLAS 2019 will gather more than 3,500 exhibitors to bring advanced solutions for the rubber and plastics industries

Plastics Recycling & Circular Economy Conference and Showcase: China's decision to prohibit the import of solid waste from other countries, and its policies designed to promote development of renewable resources represent only the beginning of some structural changes. More sustainable development and environmental protection policies are bound to come. In this new era of the circular economy, China highly values the development of the renewable resources industry. What is more, recycling technologies are constantly evolving and improving, providing a boost to the industry. Focusing on the concerns of the industry, CHINAPLAS 2019 and CPRJ - China Plastics and Rubber Journal will jointly host the "Plastics Recycling & Circular Economy Conference and Showcase" in Guangzhou on May 20, 2019. Integrating conference and exhibition elements, the one-day, specialized event will feature more than 20 expert presenters, and is expected to attract more than 300 elite attendees from the plastics, rubber and packaging industries. The conference is built around three themes: "Material Science for Sustainability", "Recycling Technology" and "Environmental Packaging".

Industry 4.0 Factory of the Future: How to speed up the implementation of industry 4.0, which continues to sweep the globe? Industry practitioners who aspire to see in real life the operation of a future factory or to find solutions to practical problems can visit the "Industry 4.0 Factory of the Future" at CHINAPLAS 2019. The event is a product of combined force of the show's organizer and core supporters of Industry 4.0 – iPlast 4.0, EUROMAP and VDMA. What makes this conference different and stand out from previous Indus-

try 4.0 events is that visitors can personally experience the real "Industry 4.0 Factory of the Future". There will be two themed areas, "Manufacturing Intelligence Control Room" and "Smart Factory", to demonstrate implementable intelligent solutions. The control room will be located on the viewing deck of Hall 4.2 in the Exhibition Hall. It will display operational data recorded at both the on-site machines and a remote smart factory, while the "Smart Factory" located at Booth 4.2D01 in the "Smart Manufacturing Technology Zone" will simulate the production environment of the future manufacturing industry and demonstrate how engineers and the control room communicate through data. Visitors can view 15 simulation scenarios – from production, management and supply chain, including shift handover, KPI monitoring at multiple production sites, and material traceability. Moreover, CHINAPLAS 2019 also will offer customized consultation.

Design x Innovation: Industrial design continues to be a popular topic at CHINAPLAS. "Design x Innovation" comprises three parts: "CMF Inspiration Walls", "Design Forum" and "CHINAPLAS Designers' Night". The "CMF Inspiration Walls" reflect three key elements – Color, Materials and Finish – and they reveal some of the emerging technologies being developed to advance CMF design for plastics. Last year, the technicolor exhibits from Springfield CMF Technology Co. Ltd. enthralled and impressed visitors, who scrutinized and touched more than 140 samples of products made using Springfield's Differential Pressure Overlay Decoration (DOD) process. Covestro and Springfield will be repeat sponsors of this event, and the show organizer is pleased to welcome first-time participating company PolyOne. The show organizer is also increasing the number of display locations from two to three. CHINAPLAS 2019 will feature Design Forums in two locations, fashioned around two themes, including "CMF Design", a popular theme from last year, and "Design for Recycling/Sustainability" in response to the show's focus on "Green Technology".

"Medical Plastics Connect" activities include "Open Forum", "Pop-up Kiosk", "Medical Plastics Guidebook" and "Medical Plastics Guided Tour"

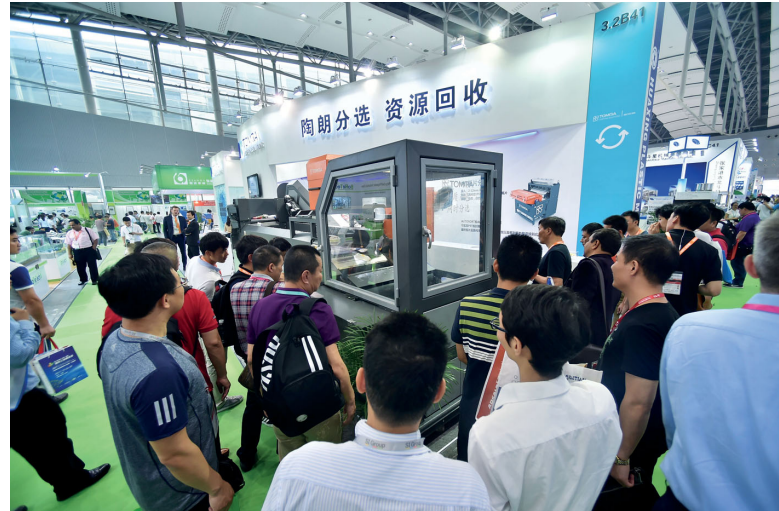

There are recycling related exhibits at CHINAPLAS

Tech Talk, celebrating its third year, has become part of the repertoire of CHINAPLAS. This year, it will be held from May 21-23, and its topics will drill deeper into the application industries and highlight practicality. It will not only showcase major technological breakthroughs of exhibitors, but also provide a platform for professional buyers to better understand the challenges currently facing the plastics and rubber industries.

By way of open forums, the event will bring together the highlights of CHINAPLAS 2019, showcase the latest and hottest product technologies of the year, and focus clearly on cutting-edge solutions in automotive, electrical and electronics, building and construction, packaging, and other industries.

Medical Plastics Connect: The medical plastics market continues to evolve and develop, with more exhibitors plunging into that field, which has great potential and value. A gem of CHINAPLAS for the past four years, "Medical Plastics Connect" actively promotes medical-grade chemical raw materials and equipment to create an efficient communication platform for medical device, consumables, and pharmaceutical packaging manufacturers. These activities aim to pinpoint for potential buyers the unique medical plastics technologies among the many exhibits active in this sector.

Over 70 not-to-be-missed technical seminars: In addition to a series of concurrent events, there are more than 70 technical seminars at CHINAPLAS 2019. The organizer will also hold a number of activities extending to multiple application industries to help the industries grasp the current situation of the market.

Robust Agenda to achieve Circularity of Plastics

■ In response to the European Plastics Strategy, the European Technology Platform for Sustainable Chemistry (SusChem) and partners issue new report: Plastics Strategic Research and Innovation Agenda in a Circular Economy. This report identifies the challenges to plastics circularity and defines the types of solutions needed to address them. Future research is required in three main areas: Circularity by design, recycling and alternative feedstock. SusChem Chairman Dr. Markus Steilemann said: "The Plastics industry is committed to increase the resource efficiency of its production processes and to face the challenge of closing the circularity loop. The new Research and Innovation Agenda gives fresh impetus on the strongest way to drive progress along plastics value chains by means of collaboration".

The analysis from this report has helped to identify priorities, projects and the level of investment needed to achieve full circularity of plastics. SusChem and its partners – Cefic, PlasticsEurope, European Plastics Converters (EuPC) and the European Composites, Plastics and Polymer Processing Platform (ECP4) – will use this report as their main input to EU innovation policy on the circularity of plastics. We hope this document will inspire an increase in number of collaborative projects as well as European and member states support for a full implementation of the solutions proposed.

■ **The European Technology Platform for Sustainable Chemistry**
suschem.org
PlasticsEurope
www.plasticseurope.org

Global Recycling Day – „Recycling into the Future“

■ With less than two months to go until the second annual Global Recycling Day on 18th March 2019, the Global Recycling Foundation is bringing cities and organisations together from across the world to encourage everyone recognise the role we can all play in improving the circular economy. In 2018, Global Recycling Day saw over 13 million people take part in recycling awareness and celebrating initiatives across the world. This year, the theme is "Recycling into the Future", focusing on the importance and power of youth, innovation and education in ensuring a brighter future for the planet. On the 18th March, official Global Recycling Day events will take place in numerous cities around the world. Organisations in these cities will work with schools and young people to raise awareness of recycling through special events and competitions, as well as asking individuals to make a pledge to change their recycling habits. Founding President of Global Recycling Foundation, Ranjit Baxi, says: "The success of the first Global Recycling Day in 2018 showed just how many millions of people across the world are willing to support recycling. We now want to spread the message further and make sure that the importance of better recycling practices is at the forefront of everyone's minds. The second Global Recycling Day will allow the Global Recycling Foundation to communicate with young people globally, ensuring they know of the positive impact they can have on the future of the planet and the preservation of our natural resources. The future is in our hands and together we can make a difference."

■ **Global Recycling Foundation**
www.globalrecyclingfoundation.org
 #GlobalRecyclingDay

Recruitment

■ "Guill announced it is actively seeking sales representatives for its extrusion tooling and rheology lab services in the global market," says Tom Baldock, manager of the sales rep organization at Guill, based in West Warwick, Rhode Island (USA). "We have seen a big increase in our sales activity in Asia and especially Europe, so we are looking to partner with sales rep groups who are skilled in the plastic and rubber extrusion markets." Guill is a recognized leader in the design, engineering and production of extrusion dies, crossheads and auxiliary equipment for extrusion processes including wire & cable, medical tubing, pipe and profiles.

■ **Guill Tool & Engineering**
tbaldock@guill.com
www.guill.com

**High quality
pigment and additive
masterbatches**

- **WHITE AND BLACK**
- **COLOUR**
- **ADDITIVES**
- **LIQUID COLOURS**
- **SPECIAL COMPOUNDS**

CONTACT US:

HEAD OFFICE: Optikov str, 4,
 Saint Petersburg, Russia
TEL: +7 812 346 78 82
E-MAIL: BAR52@BAR52.com
WWW.BASCO-MASTERBATCH.COM



We make the world colourful

*Over 25 years of experience
 in MB production*

22,000 mt annual capacity
ISO 9001 - 2015

**WE ARE LOOKING FOR THE
 PARTNERS ALL OVER THE WORLD!**

BARS-2 THE SCIENTIFIC
 AND PRODUCTION COMPANY

The Positive Trend for the Bioplastics Industry remains stable

■ The results of the European Bioplastics' annual market data update, presented at the 13th European Bioplastics Conference in Berlin, confirm a stable growth of the global bioplastics industry. "The global market for bioplastics is predicted to grow by roughly 25 percent over the next five years", says Hasso von Pogrell, Managing Director of European Bioplastics. "This trend is possible thanks to the increasing demand for sustainable products by both consumers and brands alike, stronger policy support for the bioeconomy, and the continuous efforts of the bioplastics industry to develop innovative materials with improved properties and new functionalities."

The global bioplastics production capacity is set to increase from around 2.1 million tonnes in 2018 to 2.6 million tonnes in 2023. Innovative biopolymers such as PLA (polylactic acid) and PHAs (polyhydroxyalkanoates) are driving this growth. PHAs are an important polymer family that has been in development for a while and that is entering the market at a larger commercial scale, with production capacities set to quadruple in the next five years. These polyesters are bio-based, biodegradable, and feature a wide array of physical and mechanical properties. Production capacities of PLA are set to double by 2023. PLA is a very versatile material that features excellent barrier properties. High-performance PLA grades are an ideal replacement for several conventional fossil-based plastics such as PS (polystyrene) and PP (polypropylene).

Bio-based, non-biodegradable plastics, including the drop-in solutions bio-based PE (polyethylene) and bio-based PET (poly-

ethylene terephthalate), as well as bio-based PA (polyamides), currently make up for around 50 percent (1 million tonnes) of the global bioplastics production capacities. The production of bio-based PE is predicted to continue to grow as new capacities are planned to come on line in Europe in the coming years. Intentions to increase production capacities for bio-based PET, however, have not been realised at the rate predicted in previous years. Instead, the focus has shifted to the development of PEF (polyethylene furanoate), a new polymer that is expected to enter the market in 2023. PEF is comparable to PET, but is fully bio-based and furthermore features superior barrier and thermal properties, making it an ideal material for beverage bottles. In 2023, bio-based polypropylene is expected to enter the market at commercial scale with a strong growth potential.

Packaging remains the largest field of application for bioplastics with almost 65 percent (1.2 million tonnes) of the total bioplastics market in 2018. The data also confirms that bioplastics materials are already being used in many other sectors.

The market data update 2018 has been compiled in cooperation with the research institute nova-Institute (Hürth, Germany). The data for the global production capacities of bioplastics is based on the market study "Bio-based Building Blocks and Polymers" by nova-Institute (2019). For more information on the study and full market data report, please go to:

■ European Bioplastics
www.bio-based.eu/markets

ISO Certification achieved

■ In an ongoing effort to strengthen efficiencies and customer satisfaction, Davis-Standard's Pawcatuck facility recently became ISO 9001:2015 certified. The certification validates Davis-Standard's processes across the board, internally and externally, and serves as a benchmark for the company's commitment to operational quality and process improvement.

"ISO requires the implementation of a demonstrated quality management system, promoting a holistic approach to evaluating your operation," said Mike Newhall, Davis-Standard's Vice President of Operations. "It has driven corrective action where

we've needed it, and has made every aspect of our business better. This encompasses everything from how we on-board employees and review customer specifications to our engineering and manufacturing practices. There is no stone left unturned, which results in an improved capacity to achieve customer expectations each and every time."

At the core of ISO certification is the ability to consistently provide products and services that meet customer and applicable statutory and regulatory requirements while also enhancing customer fulfillment through an effective quality management system (www.iso.org). Because of this, Newhall noted that all issues are addressed at the source.

"The ISO process is invaluable in making every department better," said Newhall. "It's also just the beginning. It is a continuous improvement process to improve our performance in all areas of the business. Being ISO certified gives our employees and customers the assurance the system is accessed and approved on a regular basis. It is a sustainable approach that holds us accountable to what we promise with the Davis-Standard brand."

ISO 9001 2018
 Certification Logo



■ Davis-Standard, LLC
www.davis-standard.com

Strategic Cooperation in Mexico for Flexible Packaging Machines

■ "For two years GEPP has been considering to start its own internal production of shrink and stretch film in order to optimize packaging costs for all its dedicated plants around Mexico. The aim of the project is to produce more than 14.000 tons/year of shrink film and more than 4.500 tons /year of stretch film. We needed to find a partner with a strong knowledge on both blown and cast technology, capable to supply Grupo Gepp with state of the art solutions to achieve this strategic goal. We made up our mind for AMUT GROUP", says Geronimo Rotundo, Director of Proplasa, the vertical integration for plastic of GRUPO GEPP, S.A.P.I. de C.V. during the acceptance test of the first blown line ready to be delivered.

"The supply includes: three co-ex lines for blown PE shrink film, one cast line for stretch film, one slitting machine, a system for the recovery of flawed rolls, chiller, piping for water distribution plus an intensive training programme for GEPP technicians", says Riccardo Castello, AMUT DOLCI EXTRUSION Division Sales Director.

With AMUT machines, GEPP will produce shrink & wrapping film for beverage items in order to bundle them.

"We've been asked to supply a turnkey project to GEPP, including a local support for the installation, training and After Sales Service in the area of Mexico City", says Alberto Rincón, Sales Manager for Latin America area.

Since 2011, GEPP is one of the largest Bottlers operations company in Mexico and it is moreover the exclusive partner in charge of bottling for PepsiCo Mexican branch. GEPP has its own water brand, Epura, and collaborates also with other important brands.

The three blown extrusion lines are identical and each one has a 3-layer shrink PE film configuration, net width of 2.400mm and capacity of 800 kg/h with 50 µ of thickness. The latest generation of "rising type" automatic ring performs an extremely precise thickness control with very low tolerance.

The cast line will produce 5-layer stretch film with net width of 1.500 mm. The line is based on 4 extruders with water cooled drives and the PROWIND 4.0 super-fast winder (speed up to 1.000 m/min) suitable for hand, machines and jumbo rolls.

The slitting machine – BVR model – has independent arms, reaches a speed up to 900 m/min and slits in-line rolls with Ø 800 mm.

All lines branded AMUT feature in-house designed and manufactured extruders suitable for every application. In this way customers are granted proven successful performances in polymers processing arising from AMUT extensive experience in this field.

AMUT DOLCI EXTRUSION
www.amutdolciextrusion.it

plasmec
 Excellence in Mixing

For over **50 years** a landmark
 in the international market
 for the **manufacturing**
 of **complete mixing plants**

PVC DRY BLEND - POWDER COATINGS
 MASTERBATCH AND PIGMENTS - THERMOPLASTIC RUBBER
 WOOD PLASTIC COMPOSITES

**PLAST
 IMAGEN**

MEXICO 2019
APRIL 2 - 5

Italy Pavilion
 Stand 431A

 **Chinaplas®**
 国际橡塑展
2019.5.21-24
 Guangzhou, PR China

Hall 4.1
 Stand T35

PLAS MEC S.R.L.

Via Europa, 79 - 21015 Lonate Pozzolo (VA) ITALY
 Tel: +39 0331 301648 - E-mail: comm@plasmec.it
www.plasmec.it

 100% MADE IN
 ITALY



Global Alliance to End Plastic Waste co-founded

■ BASF co-founded a global alliance of nearly 30 companies to advance solutions that reduce and eliminate plastic waste in the environment, especially in the ocean. The Alliance to End Plastic Waste (AEPW) has committed over \$1.0 billion with the goal of investing \$1.5 billion over the next five years to help end plastic waste in the environment. New solutions will be developed and brought to scale that will minimize and manage plastic waste. This also includes the promotion of solutions for used plastics by helping to enable a circular economy.

"We strongly support the aim to reduce plastic waste in the environment," said Dr. Martin Brudermüller, Chairman of the Board of Executive Directors and Chief Technology Officer of BASF SE, who supported setting up the Alliance from the beginning. "We are co-founding the Alliance to End Plastic Waste, because we want to drive and promote solutions that will effectively help solve the world's plastic waste problem," explained Brudermüller. "Plastics are efficient materials that can save resources and enable health, safety as well as convenience benefits for society. These benefits could be contradicted, if plastics and their waste are neither used nor disposed nor recycled in a responsible manner."

Understanding where the plastic waste originates from is key. Research by the Ocean Conservancy shows that plastics in the ocean predominantly originate from litter on land. Most of the plastic waste is spread through rivers and can be traced back to ten major rivers around the world, mainly in Asia and Africa. Many of these rivers flow through densely populated areas which have a lack of adequate waste collection and recycling infrastructure, leading to significant waste leakage. The AEPW will initiate actions where they are most needed. This will include projects that contribute to solutions in four key areas:

- Infrastructure development to collect and manage waste and increase recycling;
- Innovation to advance and scale up new technologies that make recycling and recovering plastics easier and create value from post-use plastics;
- Education and engagement of governments, businesses, and communities to mobilize action; and
- Clean-up of concentrated areas of plastic waste in the environment, particularly the major conduits of waste, such as rivers, that carry land-based waste to the ocean.

The alliance is a not-for-profit organization that includes companies from across the global plastics and consumer goods value chain: chemical and plastic manufacturers, consumer goods companies, retailers, converters, and waste management companies. The alliance will work with governments, intergovernmental organizations, academia, non-government organizations and civil society to invest in joint projects to eliminate plastic waste from the environment.

The following companies are the founding members of the Alliance to End Plastic Waste: BASF, Berry Global, Braskem, Chevron Phillips Chemical Company LLC, Clariant, Covestro, CP Group, Dow, DSM, ExxonMobil, Formosa Plastics Corporation USA, Henkel, LyondellBasell, Mitsubishi Chemical Holdings, Mitsui Chemicals, NOVA Chemicals, OxyChem, PolyOne, Procter & Gamble, Reliance Industries, SABIC, Sasol, Shell, Suez, SCG Chemicals, Sumitomo Chemical, Total, Veolia, and Versalis (Eni).

■ BASF SE
www.basf.com

Further Expansion in Mexico

■ "Given the highly positive turnover trends that we had seen in Mexico over the years, it seemed logical to invest in our sales partner GiTamsa in order to boost our growth in Central America and continue expanding our market," Carsten Koch, Managing Director of Werner Koch Maschinenteknik GmbH, reported.

Since the foundation of GiTamsa seven years ago, KOCH-Technik has been successfully cooperating with the Mexican company based in Querétaro. Now it has acquired a majority stake in GiTamsa.

Armando Feregrino, founder and Managing Director of GiTamsa, relies on a team of more than 30 employees. Of the seventeen sales and administration employees, six are responsible for the area around Querétaro. The service and installation team counts thirteen highly qualified technicians.

Many well-known customers from the automotive, packaging and medical technology sectors already rely on high-quality equipment and systems produced by KOCH-Technik.

*KOCH-Technik Managing Director Carsten Koch,
GiTamsa Managing Director Armando Feregrino and Michael
Rentschler, Sales Director for Mexico (from left)*



Apart from the desirable steady growth of its project business in Mexico in recent years, KOCH-Technik continues to lay great emphasis on strengthening customer relations. Therefore, the existing site in Terra Business Park in Querétaro is currently being expanded by 1,000 m². A new sales and training centre for up to 30 people is also under construction. KOCH-Technik thus hopes to acquaint its Mexican customers better with its range of products. Completion is scheduled for March/April 2019.

“The new sales and training centre – also known as TechCenter – is necessary in order to train our clients on site, so that they can become familiar with our equipment and systems under production conditions,” said Michael Rentschler, KOCH Sales Director for Mexico. “The new TechCenter will display our entire range of products, including a central conveying and drying system.”

Aspiring to expand its market presence in Northern Mexico, KOCH-Technik has acquired a property in Saltillo, near

Monterrey, to open up another sales office and TechCenter. Counting two regional sales agents and two service technicians, the office will start operating in early 2019. By the end of next year, KOCH-Technik will open up a second TechCenter.

“From the outset, our cooperation with KOCH-Technik has always been characterized by trust and a sense of partnership. We complement each other perfectly, making effective use of our synergies. Our amalgamation is going to strengthen our position in the Mexican market even further,” Armando Feregrino, Managing Director of GiTamsa, said with evident satisfaction.

KOCH-Technik
 Werner Koch Maschinenteknik GmbH
www.koch-technik.com

An Excellent Measurement Experience



- Precision measurement for wall thickness, eccentricity and diameter
- Quality at its highest level
- A measurement to rely on



Visit us at:



14-16 May, 2019
 Atlanta, GA, USA
 Booth # 1540

Zumbach

SWISS PRIME MEASURING SINCE 1957

www.zumbach.com • sales@zumbach.ch

Slowdown in Foreign Trade for Italian Manufacturers of Machinery, Equipment and Moulds for Plastics and Rubber

■ Imports +11.4%, exports -0.6% in the period January to September 2018 with respect to the first three quarters of 2017 according to analyses by the Amaplast Statistical Studies Centre of ISTAT foreign trade data.

The strong growth in imports, while remaining in the double digits, slowed significantly compared to +26% in March and +23% in June. Exports remained weak: toward the end of the period they dipped into negative figures and back into positive by a few decimal points on more than one occasion.

The balance of trade, well in the black at 1.62 billion euros, contracted by five percentage points. Regarding performance by machinery type, the trend is still quite positive for injection machines, extrusion lines, and blow moulding machines while dropping off for auxiliary equipment and moulds.

An analysis of exports by region shows major shifts in Asia with the Far East showing growth (+9.7%, led by India and South Korea) while things are not so bright in the Middle East (-37.1% due to falling sales in the main markets of Saudi Arabia, Iran, UAE, and Israel). As regards the New World, the NAFTA countries record positive results (+6.5%, thanks mainly to good sales performance in Mexico) while Central and South America – where Brazil holds its ground while Argentina slumps – record overall negative numbers (-12.9%).

Northern Africa has taken strong steps ahead (+13.0%), contrasting with weaker sales in the sub-Saharan markets (+0.8%). Lacklustre exports in Europe, where overall results are identical to those for the EU member states (-1.2%). The CIS countries performed poorly (-12%, mainly due to stalled sales to Russia, a market which had previously seemed to be recovering) with respect to other European countries (+14%).

“The flat trend in sales abroad comes as no great surprise given an overall economic context that is losing vigour, both in Italy and in Europe generally,” stated Amaplast president Alessandro Grassi. “Even our German competitors are coming to terms with an abrupt drop in exports, still in the double digits this past March and June, falling to +4.5% in September.”

The most recent mid-year Amaplast member survey reveals slightly less than half expecting stable turnover at the end of the



Alessandro Grassi, Amaplast president: “The flat trend in sales abroad comes as no great surprise given an overall economic context that is losing vigour, both in Italy and in Europe generally.”

current half-year, while one third expect continuing growth. As regards order books, the optimist camp makes up only one fifth of the total.

In light of these data, we expect year-end production and foreign trade results for the Italian plastics and rubber processing machinery industry roughly in line with 2017. This must be considered a positive result given that 2017 was the best in the past five years. The outlook is cautious for 2019 for two reasons:

- Uncertainties about the overall economic climate both in Italy and in Europe (with the prospect of elections in the spring), compounded by uncertainties on the global level due to tensions among the major players and the barriers – tariff and others – they have erected. Regardless of political questions, the Italian industry of plastics and rubber processing machinery has recorded an upward trend from 2010 to 2017, with the sole exception of 2013. We are now rather used to the volatility in the global economy and the current slowdown in demand has not caught anyone by surprise.

- Increasing pressure toward a more virtuous production and consumption system in keeping with the principles of the circular economy. Italian manufacturers may certainly consider themselves ready to undertake the challenge. They are able to produce systems that can handle not only virgin polymers but also recycled materials in increasingly high percentages, consuming less energy to produce items that perform. While it might be taken as a threat at first sight, the turn toward the circular economy is actually an excellent opportunity for growth for manufacturers of plastics and rubber processing machinery, equipment and moulds.

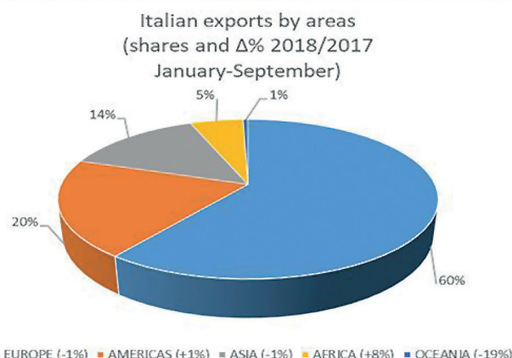

High Performance Additives and Colors for Future-Proof, Convenient Trend-Focused Coatings

■ Clariant teases the first insights into its immersive European Coatings Show 2019 (March 19-21, 2019, Nuremberg, Germany) showcase inspired by the global need for sustainable cities (Booth 7-123).

Under the theme 'Think.Do.Paint! For a new perspective', Clariant invites visitors to discover colors and additives developed to help decorative, industrial and automotive coatings make a sustainable difference to the various elements of the urbanization megatrend: homes, buildings, construction, transport and lifestyle products.

In addition, the colors of the future for automotive exteriors are ready to be explored with the launch of Clariant's new Automotive Styling Shades Trendbook 2021-2023.

People from all key industries and end market application areas for paints and coatings will be able to find added value benefits and application design freedom from the wide range of innovative Clariant products available: Safer, easier to use, sustainable solutions for homes, buildings & construction:

- New sustainable 2-in-1 dispersion additive for manufacturing safer, easier to apply, biocide-free formulations that are suitable for ecolabeled indoor paints for home and building decoration.
- New dispersant additive for waterborne organic and selective inorganic pigment and carbon black concentrates, offering enhanced colors, improved storage stability, low foaming and easier formulation.
- Sustainable wax additive based on 100% renewable resources, providing smooth touch and high scratch resistance to wood and offering enhanced pigment dispersion to increase color strength of powder coatings.
- Clariant EcoTain® certified light stabilizers for waterborne coatings, suitable for plastic, clearcoat and architectural façade coatings, bringing sustainability and performance together.
- Non-halogenated flame retardants – colorless key ingredient for transparent intumescent wood coatings, suitable on dark and light colored wood, meeting stringent fire regulations for public building applications, and ingredients for steel prolonging the shelf-life of water-based intumescent coatings and improving safety under challenging weather conditions.
- Efficient and economic production of high volume color shades for industry applications such as container ships, agricultural and construction machinery and off highway vehicles.
- Structuring of megacities with decorative roadmarkings manufactured with easy dispersible technologies.

Sustainable color boost for 'lifestyle' consumer goods, equipment & vehicles:

- Sustainable high-performance DPP (Diketopyrrolopyrrol) pigments for brilliant colors, with very high resistance to heat and UV weathering, for industrial, decorative and automotive coatings.

Think. Do. Paint!
FOR NEW PERSPECTIVES

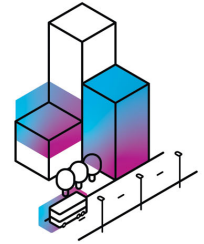

Clariant's theme at European Coatings Show 2019 (Photo: Clariant)

- Ready-to-use 'super transparent' preparations based on non-halogenated pigments for fast creation of latest designer colors and eye-catching metallic and mineral effects for consumer products needing a high quality aesthetic surface finish.
- Launch of Clariant's new Automotive Styling Shades Trendbook 2021-2023.

► Clariant
www.clariant.com

ERGE Elektrowärmetechnik
Franz Messer GmbH
91220 Schnaittach · Hersbrucker Straße 29-31
Tel. +49 9153 921-0 · Fax +49 9153 921-117-124
www.erge-elektrowaermetechnik.de

ERGE MEFLEX Ceramic Heaters
20% more heating surface
30% better heat conductance
 Together with the energy optimized ERGE WDG Heat Insulation Jacket the ultimate energy saving solution!
NEW · BETTER · FOR WINNERS ONLY

QUALITY PRODUCTS SINCE 1927

JiaXing ERGE Electric Heat Technology Co. Ltd.
 East side of bldg 4, 2299 wuyuan rd., Hai Yan, Zhejiang, China,
 Postcode: 314300, Phone +86 (573) 86 16 00 66

Effective Circular Economy for Chile

■ Around 550 farmers from the Maule region of central Chile have now joined a pilot project in the Good Agricultural Practices (GAP) campaign, organised by the Chilean Environmental Authority with support from the German disposal specialist RIGK and the environmental consultancy firm WSP. In a series of twenty workshops, the farmers received training on the management of plastic waste, before taking part in the first large recovery campaign. 35 tonnes of used mulch film, worn out irrigation hoses and empty agricultural pesticide containers were recycled or disposed of at approved disposal sites. Before this, more than half the farmers had simply burned or buried their plastic waste, making a significant contribution to the country's environmental problems.

With the GAP campaign, the Chilean Environmental Authority hopes to establish an effective circular economy in the country. To do this, it is looking to international expertise and the 25 years of experience of the German disposal specialist RIGK, who has been involved with a 100% subsidiary in Chile since 2016. The collaboration focuses on developing an effective waste management system that also works in remote regions such as Maule, which is dominated by small farms. The Chilean population has shown little awareness for environmental issues in the past. A targeted campaign of sensitisation aims to change that.

Pablo Sepúlveda, Head of the Environmental Authority for the Maule region, believes that the pilot project heralds the start of greater environmental awareness for sustainability among the population. "The Ministry for the Environment is supporting the campaign in order to reduce the plastic waste we produce every day. After all, many agricultural plastics end up



All Images: © RIGK

contaminating our fields, rivers and oceans. The project supports us in our goal of installing sustainable waste management models. It is not the end, but the beginning of a phase in which we are finding more and more concrete and effective solutions for our environmental problems."

From now on, the Chilean Environmental Authority plans to conduct regular collections of agricultural plastic waste. The pilot project will also be rolled out to other regions in Chile.

■ RIGK GmbH
www.rigk.de

New Website

■ 2019 begins with full of news for Moretto, first of all the presentation of the new website, now online and usable on all types of devices. Considering the global nature and specialization of its customers, Moretto renews his website with a communication that immediately reflects the company values.

The new graphic layout and a simple, intuitive and easy to navigate interface, allows the user to enter in Moretto's

world, to more easily explore the wide range of products and services and to stay constantly informed about the company's activities, in an increasingly connected and social perspective. Therefore, a great attention to clear and complete contents, the use of images and video to best present the technologies.

From the Home Page, the user of Moretto website selects its field of application and directly accesses to the section of products. Developed in responsive mode, it can be visited on computers, tablets and smartphones, and includes different language versions, all aligned in style and content.

The new Moretto website aims to be a new information platform able to respond immediately and effectively to the requests of an increasingly demanding clientele, which is aware of the fact that investments in automation are decisive for the competitiveness and efficiency of their business.

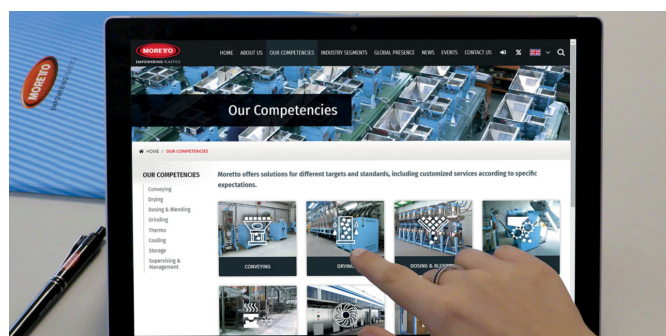

■ MORETTO S.p.A.
www.moretto.com

Call for Nominations for 'THERMOFORMER OF THE YEAR'



THERMOFORMING

■ The Society of Plastics Engineers (SPE) Thermoforming Division has announced a call for nominations for the annual Thermoformer of the Year Award. The award recognizes an individual who has made a significant contribution to the thermoforming industry in a technical, educational or managerial capacity.

The nomination deadline is March 31, 2019. Nominations will be evaluated by the SPE Thermoforming Division Board of Directors during the Spring board meeting in May.

The 2019 Thermoformer of the Year will be recognized at the awards dinner held during the 27th Annual SPE Thermoforming Conference®, which will take place September 9-11 in Milwaukee, Wisconsin. The awards dinner will take place on September 10 at the hotel and will also include the announcement of the winners of the annual Thermoforming Division parts competition.

"The Board is seeking candidates who have led exemplary careers and have contributed to and nurtured the growth of the thermoforming industry," said Juliet Goff, SPE Thermoforming Division Board Member and Recognition Committee Chair. "Over the years, the Thermoformer of the Year Award has been presented to just 36 captains of our industry."

The 2017 Thermoformer of the Year award was received by Robert Porsche of General Plastics. As a result of the cancellation of the 2017 SPE Thermoforming Conference because of a hurricane, SPE did not name a 2018 honoree so that Robert Porsche could receive the award in person during the 2018 Conference.

Guidelines for nominees and the required nomination form are posted online at: <http://thermoformingdivision.com/awards-recognitions/thermoformer-of-the-year/nomination-form/>

All materials must be emailed to Juliet Goff at juliet@kal-plastics.com by the March 31 deadline.

Full information at:

THE SPE THERMOFORMING DIVISION
<http://thermoformingdivision.com>



ATTN dries gently at a constant dew point

 think materials management

PLAST IMAGEN



MEXICO 2019
2-5 DE ABRIL

Centro Citibanamex / Ciudad de México

Please visit us:
Hall C, Stand 1214



LUXOR A

[motan-colortronic gmbh - info@motan-colortronic.de](http://motan-colortronic.com)
www.motan-colortronic.com

Co-Production of Sustainable Packaging with 50% Recycled PE

■ SONGWON Industrial announces that it has become one of the first chemical companies in the world to package its products in 20 kg PE-bags made with 50% recycled PE.

SONGWON has collaborated with the German innovative packaging specialists, RPC bpi nordfolien, to develop PE-bags for packaging 20 kg of product using recycled materials originating from different waste streams, including industrial printed bags that have already been used. All of the solvents that are required for de-inking are also recycled continuously in a closed loop process.

Sustainability is taken seriously at SONGWON and the organization embraces its responsibility to create new, more sustainable solutions in line with the United Nations 17 Sustainability Goals (SDGs). While continually striving to conserve resources, SONGWON focuses its efforts on optimizing processes and developing new opportunities to leverage combined capabilities by cooperating with other leading companies.

“With RPC bpi nordfolien, we have found an innovative partner who can support us to live SONGWON’s Vision: ‘Sound and sustainable growth for all our stakeholders in harmony with the interests of our planet and its people,’” says Maurizio Butti, Chief Executive Officer at SONGWON.



From the left: Christian Knappik, Key Account Manager / Business Unit Chemical Industry, RPC bpi nordfolien, Hwasik Jung, Ulsan Plant Manager & Cord Manegold, Global Business Manager Main AO's and Blends (Photo: SONGWON Industrial Co., Ltd.)

During the past 12 months, the recycled 20 kg bags were successfully trialed on various customers to make sure that they met SONGWON’s quality standards and those of the customers for strength, color stability and handling. SONGWON will be continuing the smooth transition to the new recyclable packaging over the next few months.

■ SONGWON Industrial Co., Ltd.
www.songwon.com
 RPC bpi nordfolien
www.nordfolien.com

Growth in Plastics Recycling Technology

■ Next Generation Group, an Austrian-based developer and manufacturer of technology and equipment for the plastics recycling industry announced a minority share investment by Ingka Group. The investment will enable the company to further develop new technology and expand its service offering in order to better serve the plastic recycling industry.

Next Generation Group is a company with more than 20 years’ experience and a leading developer and provider of equipment and technology to the plastics recycling industry. The company supports the supply growth of secondary raw plastic materials by offering a full range of post-consumer, post-industrial and PET recycling equipment. Next Generation Group is, among other things, in the forefront when it comes to the development of technology for the next dimension of PET recycling, P:REACT. Ingka Group will make a minority share investment of 24%.

Josef Hochreiter, CEO of Next Generation Group, says: “Ingka Group with their investment principles, enables Next Generation Group as a technology-provider, to in-



Headquarter Next Generation Recyclingmaschinen GmbH in Feldkirchen a.d. Donau, Austria (Image: NGR)

vest in new technologies supporting the transition from a linear to a circular economy. The shared view on our long term strategy and philosophy supports us to further grow the company”.

Next Generation Recycling was established in 1996 as a technology and equipment provider for the plastic recycling industry. The Group designs and manufactures recycling machinery mainly at their facility in Feldkirchen, Austria. The Group has 250 employees.

■ Next Generation Group
www.ngr-world.com

A New Communication Platform dedicated to Circular Economy Solutions

■ Borealis, a leading provider of innovative solutions in the fields of polyolefins, base chemicals and fertilizers, announces the launch of its new communication platform, EverMinds™. This dedicated umbrella brand has been created to heighten the visibility of plastics circularity and promote a more circular mind-set within the polyolefins industry. EverMinds serves to streamline all Borealis circular economy-related activities in order to boost their impact and engender familiarity with the topic. It aims to spark interaction and exchange between Borealis and its stakeholders. As a catalyst, it shall ultimately inspire new, high-quality and innovative polyolefins solutions based on the circular model of recycling, reuse and design for circularity.

The unique properties of plastics have been a key factor in their global success. Their malleability and versatility allow for the production of products which make daily life safer, more efficient, sustainable and convenient. Yet when insufficient effort is

made to recover and reuse plastics, and to minimise waste, the very same properties that have made them ubiquitous may have adverse effects on the environment. There is increased public awareness of the need to discard the conventional model of “take-make-dispose” in favour of a more circular one. A strictly linear way of thinking must give way to a more circular approach.



The launch of EverMinds is the most recent step in the pioneering Borealis journey to promote plastics circularity in the industry. Customers and value chain partners will now have a dynamic platform – the first of its kind in the industry – for innovation and knowledge exchange in the circular economy space. While EverMinds will be implemented across Borealis global operations, initial focus is on the European market. The platform invites Borealis partners to join together to reassess and even re-define the very nature of polyolefins applications and products. Communication focus is on four main thematic areas:

- Action is required to make the change to a circular mind-set.
- Collaboration is key to making plastics more circular.
- Customer centricity drives circularity in plastics.
- Innovation makes break-through solutions possible.

“EverMinds is a smart approach to inspire people to be more mindful of the circular economy by considering the entire life-cycle of polyolefin-based products,” says Günter Stephan, Head of Borealis Circular Economy Solutions. “Just as important, the platform will enable us to take concrete action together with our value chain partners to implement the principles of the circular economy on a wider scale in our industry.”

■ Borealis AG
www.borealiseverminds.com
www.borealisgroup.com

Standard and Custom-designed Systems for Extrusion and Calendaring of Tire Components

■ TROESTER is well known as a reliable extrusion partner and source of know-how for all major tire companies, but also a favorite choice for medium-sized and local tire producers, world wide. The company offers an extended range of standard and custom-designed systems for extrusion and calendaring of tire components. Their innovative extrusion lines for tread, sidewall, innerliner, apex and other profiles can also be offered as turn-key systems including downstream equipment and line control. The focus of TROESTER is to generate maximum benefit for their customers’ needs.

A team of specialists will be present at Tire Technology Expo 2019 to explain the latest technological developments and to answer questions.

Booth No. 7036, Hall 21

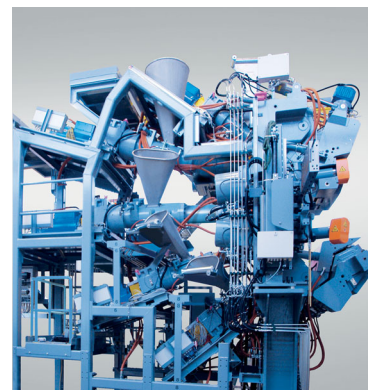

Multiple extrusion head TROESTER CoEx® 5plus1/ H500 (CoEx® is a registered trademark of TROESTER GmbH & Co. KG in Germany)

■ TROESTER GmbH & Co KG
www.troester.de

Greater Efficiency for Film Recyclers

■ Last year, Starlinger recycling technology supplemented its well-established recycling line recoSTAR dynamic with a seventh machinery size. The introduction of this new size was prompted by numerous inquiries from the area of post-consumer film, which predominantly requested a throughput of approx.

1,000 kg/h. The lines that had hitherto been available, the recoSTAR dynamic 125 and 165 (the numbers indicate the screw diameter in millimeters), were slightly under- or oversized for this capacity. The launch of the recoSTAR dynamic 145 bridges this gap: The line is designed for approx. 1 ton of regranulate and shows an optimal cost-benefit ratio that renders it very attractive also from a commercial perspective. The fields of application of the recoSTAR dynamic are manifold. Be it industrial or post-consumer waste, humid or heavily printed material – the line is extremely versatile and permits a customized setup. A central component is the SMART feeder, which on top of drying and condensing the material ensures a homogeneous mixing ratio. Recyclers of post-consumer and/or heavily printed film also operate the highly efficient degassing unit C-VAC; this module is positioned after the filter and can be controlled independently of the main extruder. In the C-VAC, the melt surface is increased by 300 %, which allows



The recoSTAR dynamic 145 with C-VAC module (©Starlinger)

the efficient removal of gases and prevents air from being trapped inside the regranulate. This is especially important for film recyclers because ink, humidity and contamination can lead to higher formation of gases during the extrusion process. Another benefit is the rECO package of the recoSTAR dynamic: It saves costs and protects the environment through a 10 % reduction in energy consumption.

■ Starlinger & Co. Gesellschaft m.b.H.
www.starlinger.com

New 800 Series Hybrid Extrusion Tooling announced

■ Guill announces the introduction of a new version of its popular 800 series, known as 800 Series Hybrid. In some extrusion applications that utilize crossheads and inlines, layers of the exact same material are applied multiple times, using a single die. This method is used to reduce the propensity for errors caused by gels breaking through a thin wall, weld lines, inconsistent wall thickness, plus material and process variations. Additional errors include difficult-to-process materials and demanding applications where there is zero fault tolerance.

Seeking to design the next generation multi-layer die to overcome these challenges, the engineers at Guill looked for a way to incorporate this technology into an updated version of the 800 Series.

This led to the creation of the 800 Series Hybrid. The inherent benefits of the 800 Series are retained, including compact design, low residence time and a common deflector bore that eliminates tolerance stack up. The challenge was to create a hybrid design that incorporates the benefits of layer overlapping, while reducing unnecessary complexity and making the technology more



cost-affordable for customers. This was achieved by overlapping layers in each semi-deflector, using a single cone. The highly efficient design of the 800 Series Hybrid reduces cost and size, as opposed to other methods of overlapping layers.

Essential benefits of the 800 Series Hybrid include eliminating weld lines in materials through patented overlapping technology, producing a more consistent finished product; reduced sensitivity to changes in viscosity; reduced sensitivity to changes in line speed; myriad material and multi-layer application possibilities; works in all tubing and jacketing applications with a wide range of materials; low residence time; compact design and a low tolerance stack-up error factor, all resulting in improved concentricity. The 800 Series Hybrid extrusion tool greatly reduces stagnation, because overlapping layers are more inherently balanced than single layers and also because each semi-deflector is “tuned to flush.” Conventional deflectors must simultaneously achieve a balance between flushing, balancing and eliminating the weld line. There is less difference between the slowest moving material and the fastest moving material in the deflector channels, thus making the viscosity more consistent in the deflector.

■ Guill Tool & Engineering
www.guill.com

Advanced Waste Collection Technologies presented to Russia

■ The ever-increasing awareness on the Russian territory of considering post-consume materials as a resource has led AMUT ECOTECH, Green Division of AMUT GROUP, to take part to the "Waste Treatment Conference" organized by INVENTRA (CREON Group) on the 22nd of October, in Moscow. Antonio Morona, AMUT ECOTECH Sales Manager, presented the topic "Waste collection integrated system – advanced sorting and recycling technologies".

AMUT ECOTECH is an Italian manufacturer of sorting and recovery plants for the following waste categories: urban, industrial, compost, recy materials, refuse derived fuel, energy, electronics, construction and demolition.

„The opportunities of doing business with Russia are growing due to the important amendments approved to the current legislation in favour of the waste recycling industry. Russia says it wants to process 80% of its waste by 2030. It is a good encouragement

for us to devote our attention to a country where the landfill and the incinerator are the most popular used method of waste disposal today" stated Morona during the Conference.

Morona showed in his speech how waste can be a real resource

if properly treated: ALUMINIUM can be reused at 100% for countless times; ORGANIC WASTE is used for biogas production if thermal valorized and for agricultural uses if processed with bio-oxidation;

GLASS can be recycled up to 80%;

WOOD is employed for the paper industry, for composting or energy recovery;

PAPER recycling ensures a 64 % energy saved compared to primary production;

PLASTIC, if well separated, can be reused at the 70% to produce other plastic and the 30% to produce RDF (Refuse Derived Fuel).

"Our R&D engineers are mainly focused on developing solutions to reduce the percentage of rejects during the sorting and recovery process. The impact of the landfills is expected to become increasingly contained". With these words Morona pointed out the commitment of machine manufacturers to preserving the environment and to supporting through advanced technology a cost-effective circular economy.

■ AMUT ECOTECH
www.amutecotech.it



Antonio Morona –
Sales Manager of AMUT
ECOTECH

Ballistic Separator



Cup forming – Focus on SPEED and performance

■ The Thermorunner KTR 5.1 Speed cup forming machine from Kiefel leaves nothing to be desired. It is at home both in mass production and in niche products; intelligent technology combines perfect forming quality with high production speeds. Whether yogurt cups, drinking cups, coffee capsules, cups for snap caps or plant pots - the quality of the products is determined by several factors.

The KTR 5.1 Speed scores highly when it comes to certain key factors, with its improved process parameters due to the implementation of innovative ideas.

A new cooling system ensures perfect temperatures in the tool. The fully automatic tool temperature regulation results in a 30% longer tool life compared to the predecessor model. Along with this comes a steady product quality with about 10% increased output.

The improved forming air system allows faster filling and venting of all cavities and thus supports an about 30% faster as well as precise forming process.

Cup Forming Machine Thermorunner KTR 5.1 Speed with PUS Stacker



The film transport system is also optimized with sophisticated film spreading and a feed table which protects the material surface.

There are also innovative developments on the software side in terms of process monitoring, intuitive forming process settings, "Smart Startup" and the "on-the-fly" feature, smooth transfer from forming to stacking.

A proven standard feature of the KTR 5.1 Speed is the optimal film heating. Therefore the pre- and main heating are equipped with efficient black HTS ceramic radiators. The film temperature is displayed and tracked by an infrared pyrometer.

The robust cast steel forming and punching station has the necessary high cutting force for high-precision forming/punching operations with increased cutting length. As a result, more cavities can be arranged, facilitating higher output of cups.

A servomotor driven pre-stretching ensures uniform material distribution all the way to the cup bottom.

In combination with the efficient PUS series stacking machines and automation solutions, from the film roll to the packaging carton, Kiefel completes the tailor-made production line with a KTR 5.1 Speed.

■ KIEFEL GmbH
www.kiefel.com

New Technology for the Economical Reworking of Material in Rubber Processing

■ At the Tire Expo 2019 (5th to 7th March, Hanover/Germany) UTH GmbH from Fulda/Germany will be presenting its extended product range at Stand 4012, Hall 20. The company will be introducing its innovative solution for reworking material generated in rubber processing: the TRP Reworker System.

UTH's core competences include roll-ex® gear pump technology and innovative fine mesh straining solutions. These technologies enable rubber and tire manufacturers worldwide to meet the challenges of rubber processing. The demand is for products of the highest quality as well as greater cost-effectiveness.

At the 2019 Show, as an extension of its innovative product range, the company will present its new TRP Reworker System which is based on the UTH Two-Roll-Plasticiser (TRP) with integrated gear pump. This new high-performance system incorporates new technology that combines gentle rubber processing, based on an open roll system, with proven methods such as cracking, homogenizing and discharging. The innovative new TRP Reworker System is designed to gently process unvulcanized material generated during tire production and return it back to the production process. In just one single step, the TRP Reworker automatically and continuously homogenises and fine mesh strains treads, sidewalls, profiles or sheets at a low temperature. With possible throughputs of up to 2,500 kg/h per system, this technology represents a breakthrough. Energy-efficient and space-saving, the TRP Reworker from UTH provides an economical alternative to existing processes.



TRP Reworker System from UTH GmbH: new technology for the economical reworking of material in rubber processing

For more than 30 years UTH has been successfully established on the international market specialising in the development of customer-specific solutions for the rubber and tire industry. These are used in the different areas of tire manufacturing, for example, in the mixing line for the final compound and master batch, complete offline straining cells and in the extrusion line and rework area. The range of intelligent upstream and downstream equipment, which enables seamless integration in mixing lines of all sizes, is just as much a part of the scope of supply as the essential after sales service.

■ UTH GmbH
<https://uth-gmbh.com>

'ColorForward 2020'

■ Clariant announced the release of ColorForward 2020, the 14th edition of the annual color forecasting guide for the plastics industry.

While consumer preferences have been trending toward warmer tones in recent years, Clariant color-trend watchers see a shift

CLARIANT

ColorForward®
SOCIETY | TRENDS | AESTHETIC
2020



what is precious to you?

*Clariant Color Forecast Says
Greens are Back in 2020
(Photo: Clariant)*

to cooler blues and greens in the palette they developed for 2020. In fact, of the twenty colors in the latest edition of ColorForward, five of them are different shades of green. Some are genuine and natural looking, while others seem more artificial or 'digital.'

That doesn't mean the 2020 trend colors don't include some warmth, says Judith van Vliet, ColorWorks® Designer and a leader of the ColorForward team. There are a range of reds, yellows and even a couple of oranges. These tend to be bright and, in many cases translucent or tuned up with special effect pigments.

"There are a lot of things going on in the world these days," van Vliet explains. "Not all of them are negative, but the sheer volume of ideas, images and information confronting us, and the speed at which it comes at us, can seem overwhelming. Instead of trying to escape, which often seems impossible, people are seeking ways to harden themselves as a sort of emotional self-defense. We see other trends springing from developments in gene modification, increasing surveillance and loss of privacy, and the potential for ultra-high-speed travel."

■ Clariant
www.clariant.com/colorworks

X-Ray Measurement Technology for Single and Multilayer Products

■ In order for a manufacturer to select the measurement and control solution with the best price-performance ratio, the suitable technology must be chosen.

ZUMBACH's static X-ray system RAYEX® S has especially been developed for any kind of foamed pipe, vulcanized products, hydraulic hoses, etc. RAYEX® S measures and controls diameter, ovality, wall thickness and eccentricity of single and multilayer products with up to four layers. It provides precise measuring values and highest reliability for pipe and hoses with an outside diameter of up to 80mm. The system features the latest X-ray technology and software solutions.



Measuring unit RAYEX® S

In combination with the data acquisition and processor system, an automatic control of the line is possible. By controlling line speed or extruder speed the parameters are controlled to the nominal value. The display shows all measurement values numerically and graphically as well as trends and statistical data. A line presentation with pictograms of the connected devices provides a clear overview to the operator. At the same time, the system reduces the wall thickness to a minimum value. Quality assurance and the reduction of material lead to a significant increase of productivity.

Key Features and Advantages:

- High stability and accuracy
- Measuring frequency up to 10 Hz (in standard mode)
- Simple concept and easy to use
- 4 wall thickness points, 2 diameters, ovality
- 2 X-ray sources positioned at a 90° angle
- No recalibration is necessary but can be done if required
- High safety level of the X-ray sources
- Unique screening concept
- Outside radiation level meets national and international standards
- X-ray sources
- Extremely robust and stable
- Easy to exchange, no realignment
- No water cooling required

■ ZUMBACH Electronic AG
www.zumbach.com

New Branch Office in India

■ GOEBEL IMS, one of the world's leading manufacturers of slitting and winding solutions, announces the opening of a new branch office in Vadodara, Gujarat/India. The globally renowned brand of the IMS TECHNOLOGIES GROUP, has been recording an increase in international orders across all industries for many years – a significant share coming from the Indian market. With its new branch, GOEBEL IMS strengthens its group's long-term go-to-market strategy while being able to better serve a broader geographic area. GOEBEL IMS and its comprehensive portfolio of versatile machines have been well-known in the Indian market for many years leading to an increasing number of local references.

The new branch office will be led by Sunil Prabhakar Ghanekar. He brings his extensive experience of 35 years in the industrial film and flexible packaging manufacturing and converting business to the table. His exceptional technical competence and market knowledge of the packaging film business adds a great value to the company.

"We are very pleased to set this new milestone in the Indian market together with our highly esteemed sales and services expert

team. Ghanekar has the know-how to represent our cutting-edge innovations, tailor-made solutions and high-quality services. With him we are looking forward to expanding our market position," states Daniele Vaglietti, Managing Director Sales and Marketing of GOEBEL IMS' parent company IMS TECHNOLOGIES GROUP.



Daniele Vaglietti
and Sunil
Prabhakar
Ghanekar

■ GOEBEL IMS' new Indian office
Mr. Sunil Prabhakar Ghanekar, Country Manager India,
sales.india@goebel-ims.com

Expansion in Far East COLINES® enters a prestigious partnership with Rieckermann

■ COLINES® announced a new partnership with the international industrial solution provider Rieckermann. The alliance will see Rieckermann representing COLINES® and providing after-sales service in six Asian countries: China, Thailand, Vietnam, Korea, Japan and the Philippines.

The agreement, which commenced on January 1, 2019, aims to strengthen the presence of COLINES® in the Far East. With decades of experience in the Asian market, Rieckermann is an ideal partner to help achieve this objective.

"We are proud of this new cooperation with a sound and successful company as Rieckermann is," explains the Chief Executive Officer of COLINES®, Eraldo Peccetti. "We are sure that the synergy between our companies will help us to further grow in the Asian countries, which are experiencing a strong development and can be a very important market for us in the future".

"We are excited to embark on our newly formed partnership with COLINES®, as our customers can certainly benefit from their innovative ideas, broad portfolio, and the unique solutions they offer," says Rieckermann's Director of Plastics & Converting Industry, Kristian Rieck. "With our mission to make the most out of industrial production and processes,



Colines company site in Novara, Italy (2016)

we are confident that COLINES® vertically integrated structure, process and application know-how will support our customers to drive their business forward".

■ COLINES®
www.colines.it

Spare Parts produced in Record Time

■ In the event of (imminent) machine downtime, machine spare parts are often required in record time. Windmüller & Hölscher has 90 percent of all required original spare parts directly available from stock. But there are also rare consumables or old machine parts that are not stored. The W&H express production closes this gap: Simple to medium complex machine components that have been manufactured to

In the Express Manufacturing Service at W&H rare machine spare parts can be produced and delivered in less than 24 hours



customer specifications (drawing parts), can be rebuilt and delivered in less than 24 hours.

"Our express service for spare parts works in a similar way to an emergency room: the most important thing is to stabilize the patient, i.e. the machine, and keep it alive. This is how we prevent production shutdowns. We get very positive feedback from our customers for the fast immediate help," says Jörg Dellbrügge, Head of W&H Service Logistics. The conventional delivery time for rare consumables that are not stored in stock is two weeks or longer. W&H's express spare parts, on the other hand, can be on their way to the customer just one day after receipt of the order. "It always depends on the urgency of the order. A spare part from us is sometimes just an interim solution until the final machine part is finished. If, for example, this still has to be refined, experience has shown that production always takes a little longer."

Express manufacturing was set up as an additional service in April last year. Since then, express production has successfully completed more than 200 rush orders.

■ WINDMÜLLER & HÖLSCHER KG
www.wuh-group.com

Extruders & extrusion lines

Made in Germany

Visit our homepage with many used machines for the plastic extrusion business:

Extrusion lines for small profiles, tubes, etc.
cooling tanks, puller, winder, etc.
used extruders and extrusion lines

www.pmh-extruder.com pmh.gmbh@t-online.de



Plastic-Maschinen-Handelsges. mbH

Broichhausener Str. 4 · D-53773 Hennef
Tel. +49-2244-83041 · +49-(0)173 150 4512



Extruder 30 mm - 28 l/d
immediately available

In-House Product Range expanded after Company Participation

■ On 1 January 2019, the Austrian EREMA Group acquired 60 percent of the recycling machine manufacturer PLASMAC Srl to further expand its range of tailor-made plastic recycling solutions for in-house applications. The remaining 40 percent of the recycling machine manufacturer is owned by SYNCRO Group, a manufacturer in Italy that makes equipment for the blown film industry.

PLASMAC has been active worldwide as a manufacturer of recycling plants since 1994 and was previously based in Aylesbury, England. In June 2018 the SYNCRO Group relocated the business to Busto Arsizio (Italy) and in January 2019 Plasmac Srl was newly established. The CEO of PLASMAC Srl is Gabriele Caccia, who is also CEO of the SYNCRO Group.

PLASMAC has comprehensive expertise in edge trim recycling and with their Alpha direct feed extruder and Omega shredder-extruder system offers easy-to-use solutions for throughputs of up to 250 kg/h. This range is supplemented by the Powerfeed edge trim transport system.



Gabriele Caccia, CEO
PLASMAC Srl



Manfred Hackl, CEO
EREMA Group GmbH
(Photo credit: EREMA)

With technological developments such as the INTAREMA® system and the founding of the subsidiary PURE LOOP, which specializes in shredder-extruder technology for the recycling of clean production waste, the EREMA Group has already successfully strengthened and expanded its presence in the in-house segment in recent years. For Manfred Hackl, CEO of the EREMA Group, the acquisition of a stake in PLASMAC is a further step towards maintaining EREMA's leading market position: "It enables us to offer in-house customers tailor-made recycling solutions with an attractive price/performance ratio so that our group of companies can reach new customer groups and markets," he explains. Gabriele Caccia is also looking forward to working together as part of the EREMA Group. He is sure that "All companies involved will benefit from the partnership with the world market leader in plastics recycling technology".

Biopolymer Films Market Value

■ The food & beverage segment led the global biopolymer films market end-user base in 2017. Escalating packaged food demand, particularly due to increasing per capita income, along with growing number of working populations across the globe will boost industry size. For instance, packaging products from biopolymers films are used in the packaging of fresh food, tetra packs, dry snacks, bakery goods, juice bottles, and meat trays along with coatings for beverage cups, films, and card stock.

Global Biopolymer Films Market will surpass USD 6.7 billion by 2025, according to a new research report by Global Market Insights, Inc. The overall market size is majorly driven by increasing demand for eco-friendly packaging among consumers. This has urged plastic manufacturers and packaging vendors to shift their focus toward biopolymer packaging and implement strategies for its branding and customer acquisition in coming years. This shift towards organic packaging of premium food items, medicines, and other consumer goods will propel the overall market growth. Furthermore, establishment of edible biopolymer films in the food market will complement the overall industry share over the estimated timeframe.

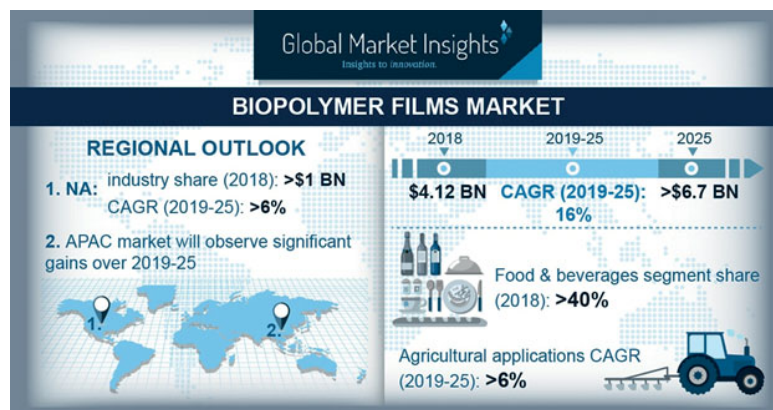

Global Market Insights
www.gminsights.com

Request for a sample of this research report
@ <https://www.gminsights.com/request-sample/detail/205>

Expansion of OPP Film Manufacturing

■ Toray Plastics (America) announced that it is investing in a new, state-of-the-art 8.7 meter polypropylene film line. The expenditure marks the next phase

Toray Plastics (America) is investing in a state-of-the-art 8.7 meter OPP film line and constructing a new building to house the equipment



of Toray's multi-year strategic plan, begun in 2016, to expand and automate production capabilities in order to meet customer demand and maintain its leadership position. The new capacity is targeted for packaging, label, medical, and industrial applications. Toray anticipates start-up in 2020.

"Toray's commitment to our customers is unwavering, and this expansion continues our path of innovation and growth," says Christopher Roy, Senior Vice President and General Manager, Torayfan® Division. Roy notes that this expansion project features the construction of a new building to house the OPP equipment. Previously completed projects include the construction of a second cogeneration system, automation throughout the plant, including a fully automated packaging line, and the construction of a 28,800-square-foot facility to house a new, high-speed 4.5-meter metallizer..

Toray Plastics (America), Inc
www.toraytpa.com/

Free Trainings Seminars at Compounding World Expo

■ 8-9 May 2019, Cleveland, Ohio, USA

Visitors to the Compounding World Expo will be able to attend a series of six free training seminars on a range of plastics compounding topics. The practical seminars will take place over both days of the exhibition. The topics being covered in the training seminars include process optimisation, compound formulation, regulatory compliance, polymer stabilisation, machine specification, and colour measurement and control. "The practical seminars will be delivered by acknowledged experts and experienced trainers," explained Andy Beevers, events director at AMI, the organiser of the exhibition. "We want to provide visitors with valuable educational content, in addition to the opportunity to meet more than 140 suppliers who will be exhibiting at the Compounding World Expo." The opening training seminar will cover the specification of twin-screw extruders for compounding. It will be given by Adam Dreiblatt, the director of process technology at CPM Extrusion Group. The second training seminar will focus on regulatory compliance. Bernie Henn, supplier development manager at Verisk 3E will speak

about modernising product stewardship for compounded, extruded or recycled plastics. The next free training seminar will focus on understanding and formulating plastics compounds and will be delivered by Chris DeArmitt, president of Phantom Plastics. The first free training seminar on the second day of the Compounding World Expo will focus on top tips for optimising twin-screw extrusion and it will be given by Bert Elliott, engineering manager at Leistritz Extrusion. The vitally important topic of evaluating and controlling colour in plastics will be covered in a seminar by Frank Koger, technical sales engineer at Konica Minolta Sensing Americas. The final training seminar will be on understanding the basics of polymer degradation and stabilisation. It will be delivered by Ronald Becker, business development manager at SI Group who speaks regularly on this fundamentally important topic for compounders.

For more information:

► <https://compoundingworldexpo.com/na/>

Latest Highlights at PLASTEC WEST

■ Moretto USA, daughter company of Moretto S.p.A., the leading Italian provider of Material Handling, Drying, Blending, Heat Transfer and Size Reduction equipment, attended PLASTEC WEST in Anaheim, California, North America's biggest annual plastics trade show.

Providing innovative standard as well as customized systems, Moretto's goal has always been to maximize process efficiency,

guarantee final quality and energy savings for their worldwide injection molding, extrusion and PET processing customers.

Moretto strengths include not only precise, innovative equipment, but in-depth pre and post-sale service targeted to measurably improve the customer's production processes, and assure easy and intuitive operation by users of all skill levels.

Moretto USA, celebrating multiple years of both commercial success in the US and their recent relocation to a new, centrally located facility in Western Pennsylvania, displayed the complete Moretto product range at Plastec West.

With explosive sales activity in the last year, Moretto's USA subsidiary is recording the fastest growth of any auxiliary supplier in North America. The USA office, established in 2015, has efficiently provided products and systems to leading companies in the PET, medical and automotive sectors. To maintain customer support and extend the sale of Moretto products, the US operation recently expanded to a bigger (30,000 Sq. Ft) facility in Western Pennsylvania, a strategic location to efficiently serve plastics processors. Included, are sales, an extensive inventory of products and spare parts, an assembly shop, and a Moretto product showroom, designed for customer examination and training.



► Moretto USA LLC
www.moretto.com

Blow Molding: Partnership announced

■ R&B Plastics Machinery, a leading manufacturer of blow molding machinery, single-screw plastic extruders, extruder process screws, and a machinery rebuilder, has announced a strategic partnership with Sika, a custom blow molding machine maker in Taiwan, and Seecor, a technology company based in South Africa, for the production of new fully electric, hybrid, and hydraulic blow molding machines.

The new shuttle and accumulator head machines, sold and engineered under the R&B Plastics Machinery brand, will expand the company's portfolio of blow molding machinery for the consumer packaging, automotive, and industrial markets, according to Fred Piercy, president of R&B Plastics Machinery. The launch of the new machinery also marks R&B's entry into the all-electric blow molding machine segment. The company is already a leading supplier of extrusion blow molding (EBM) machines including wheel and shuttle systems.

"This partnership will result in the development of a new series of machine platforms that will incorporate R&B technology, engineering, and know-how," said Piercy. "This business arrangement will significantly expand our machine portfolio and enable us to compete with larger rivals, particularly in the all-electric market."

R&B is an established technology developer and manufacturer, long known for its robust and dependable blow molding machine line and its highly trained customer support and service team. The company will combine modern and efficient blow mold technology and marketing approaches to offer the R&B Sika Shuttle line (RBS Series) and accumulator machines (RBA Series) throughout the North American market. The all-electric machines will consist of shuttle platforms ranging from 350mm to 1250mm long stroke, offered in both single- and double-sided machine configurations.

As a partner, Sika will manufacture systems and components which will be shipped to R&B's manufacturing facility in Saline, Mich. for final assembly and customer trials. R&B maintains all detailed drawings of the machinery, and will provide



all service and parts supply from its Saline, Mich. North American facility. Seecor will provide technology support including manufacturing guidance and design, primarily at SIKa in Taiwan.

Under the new partnership, R&B Plastics Machinery has already sold multiple new shuttle machines in the U.S.

■ R&B Plastics Machinery LLC
www.rbplasticsmachinery.com

SIKA Machinery Company Ltd.
www.seecor.com/sika.php

Seecor
<http://seecor.com/about.php>

2019 with Record Sales started

■ Film and sheet extrusion machinery supplier Macro Engineering & Technology (Canada) has had an excellent start to the year 2019. Following the success of launching Macro's new line Quadex (Bi-axially oriented multiple-bubble lines) in 2018 and adding two new agents in Spain, Portugal, and Mexico, Macro starts the new year of 2019 with tremendous growth on dies, air rings, and winders sales. "We are very excited to start 2019 with unprecedented growth in sales. This is right on track with the new machining capabilities we acquired last year in die manufacturing. It is a reassurance

from the industry that we are a leader in supplying extrusion systems and components," says Jim Stobie, Macro's CEO.

Many of these are repeat orders from our existing customers who are very satisfied with the equipment they received from Macro.

■ Macro Engineering & Technology Inc.
www.macroeng.com

North America Masterbatch Market

■ The masterbatch market is expected to grow from over USD 9 billion in 2017 to USD 13 billion by 2024, according to a 2019 Global Market Insights, Inc. report. Masterbatch market is most likely to witness growth in the forecast period due to rising demand for biodegradable masterbatches. These superior products help the plastic material to degrade after completing its shelf-life, are non-toxic, cost-effective, and ideal for food and drugs packaging applications. The biodegradable products are used for manufacturing environment-friendly agricultural films, popularly used by farmers to improve the crop production rate, maintain soil moisture and control different weathering conditions.

Packaging is one of the most significant end-user segments in the masterbatch market which is likely to grow by around 5.5% CAGR from 2018 to 2024. It is used in a varied range of applications such as food & beverage containers, medical bags, and boxes, security packaging, etc. Growing demand from the rigid and flexible packaging sectors will signify the segment growth over the coming years.

North America Masterbatch market is expected to reach at around USD 2 billion by 2024. Masterbatch demand in this re-

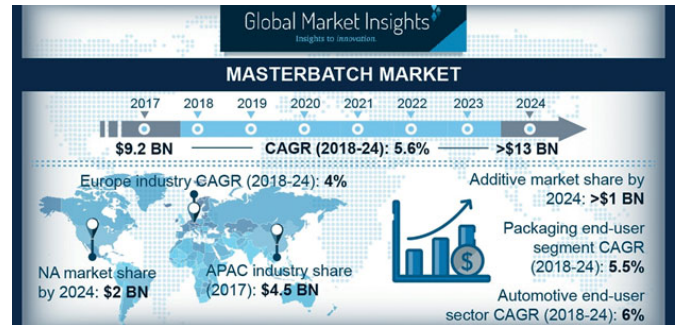

gion will witness decent growth on account of the developing construction and automotive sector.

Global Market Insights
www.gminsights.com

Request for a sample of this research report
@ <https://www.gminsights.com/request-sample/detail/2362>

First Quarter R&D Additions announced

■ The Davis-Standard Technical Center has announced two exciting additions to its lab capabilities in Pawcatuck, Conn. By the end of the first quarter, Davis-Standard will offer trials for its Davis-Standard Helibar® groove feed extruder and the DS Activ-Check control system for continuous extruder monitoring. According to John Christiano, Davis-Standard's Vice President of Extrusion Technology, both present new opportunities for customers to improve and strengthen processes.

"These technologies have been proven in the field and we're pleased to offer experimentation in our technical center," said Christiano. "We are firm believers in partnering with customers to make processes better and in maximizing their capital investments. I am eager for customers to use both the Helibar and Activ-Check in establishing performance baselines during real-world trials."

The Helibar extruder is the next generation in Davis-Standard's groove feed extruder offering. The dimensions of the extruder in the lab will be 65mm with a 36:1 L/D. With the Helibar design, helical grooves inside the barrel run along the entire barrel bore. This technology has shown to increase extruder output rates while improving energy efficiency and reducing barrel and screw wear. Other advantages include lower start-up costs, shorter residence time and the ability to process higher levels of regrind. Christiano noted this is especially beneficial for high-profile applications where speed, melt quality and efficiency are paramount.

The DS Activ-Check system will be mounted on a 4.5-inch (114mm) extruder. Using a continuous monitoring platform, the DS Activ-Check strengthens preventative and predictive maintenance for extruder operation. Operators are able to monitor key mechanical and electrical components of the extruder and gearbox and receive early notification of potential component failure to prevent unscheduled downtime. Users can obtain notifications via e-mail and text, and can remotely monitor conditions via smart devices or remote PCs. Users also benefit from the collection of operational data, leading to significant cost-cutting opportunities.

John Clemens, Davis-Standard's Director of Extrusion Controls, added: "The capability to monitor extrusion line variables such as mechanical and electrical system conditions is essential in order to bring products to market faster. I look forward to customers having the opportunity to test the many advantages of this system for both extrusion and converting processes."

Both technologies will be available to customers by the end of the first quarter.

Davis-Standard, LLC
www.davis-standard.com
John Christiano: jchristiano@davis-standard.com

ICE Europe 2017

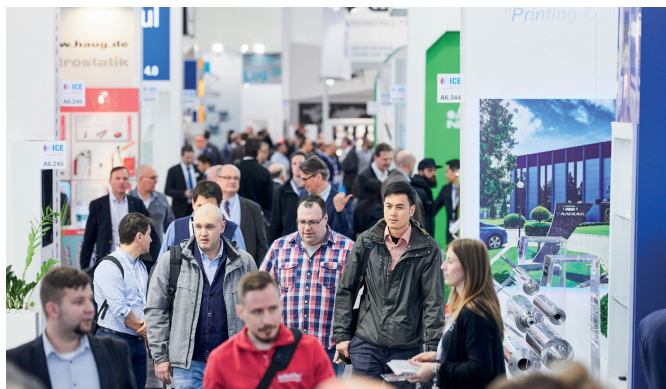

Converting Industry faces Diverse Challenges of Sustainability, Individual Customer Demands and New Technologies

From 12 – 14 March 2019, the converting industry will gather for the 11th edition of ICE Europe, the World's Leading Exhibition for Paper, Film & Foil Converting, at the Munich Trade Fair Centre in Germany. This year's ICE Europe will be bigger than ever. With 11,500 m² net floor space, the booked stand space has grown by 4% compared to figures from 2017. In addition, the number of exhibitors increased by 6%. More than 450 exhibitors will present their innovations

and latest technologies at ICE Europe 2019. The most important trends at the show will be digitalisation, individualisation and sustainability, which will also be considered at this year's ICE Awards.

The focus of this year's ICE Europe will be the digitalisation of manufacturing, the individualisation of products and the sustainability of materials and processes. Thus, the specialised trade show continues to cover the most important trends. "The converting industry faces diverse challenges: On the one hand, a growing demand for sustainable products and tighter regulatory requirements, e. g. new legislative proposals. On the other hand, the consumers' desire for individualised, high-quality products and packaging solutions as well as new developments and opportunities, that Industry 4.0 offers", explains Liljana Goszdziwski, Exhibition Director of ICE Europe, on behalf of the organisers, Mack Brooks Exhibitions.

Digitalisation and associated smart products and packaging remain an important trend in converting. Therefore, for the first time, ICE Europe

2019 will present a dedicated 'Special Film & Extrusion Area'. This new area comprises the category special films (battery films, biopolymeric films, high barrier films, optical films, weatherable films and other special films) as well as the area of extrusion (extrusion lines for blown films, extrusion lines for flat films and sheets, welding machines and calendars).

ICE Awards 2019: For the second time, best practice, excellence, innovation and extraordinary achievements will be honoured with the ICE Awards at ICE Europe 2019. Exhibitors have the chance to win an award in one of four categories, that are currently most relevant in the industry: 'Digital Converting Solutions', 'Sustainable Products and Manufacturing Processes', 'Efficient Production Solutions' and 'Special Film Innovations'. Numerous exhibitors from various countries have submitted their entries for the online voting.



Derichs at ICE Europe 2019

“High-Voltage” Development

The ICE Anniversary Award winner in the category “Industry 4.0” is not resting on his laurels from 2017. The measurement tool ED presented in 2017, which sends data in real time via Bluetooth® directly from inside the roller to an appropriate recipient (iPad, iPhone, via PC dongle to the SPS or via Ethernet directly to the server), is a product which is ready for series production today.

The ED 1, with which the temperature inside the roller can be monitored, has now been supplemented with the ED 2, which measures and monitors the working pressure on the inlet and outlet of the roller.

With the free IOS app “DERICHS Monitor”, data can be displayed and especially stored for a long period of time. Once it is programmed correctly, the user can detect deviations in target temperature and target pressure at first glance as quickly as the hugely important differential value between inlet and outlet.

The demand for the product is great also across sectors, and already 40% have been sold from the initial batch since September 2018.

Looking ahead: Next innovation is already born

Being innovative like the Krefeld/Germany, ladies, they are already starting a new development. In cooperation with the Technical University of Clausthal/Germany they are developing a contactless inline roller cleaning system. “When our clients ask us for solutions, we feel challenged”, Managing Director Stephanie Holzmann says. “When you are always curious and able to look and listen beyond your own nose, this often creates fantastic symbioses”.

“Almost any film manufacturer will be familiar with the issue of roller surface cleaning”, Managing Director Maria Barths states. “Many companies have extremely high downtime costs because the process must frequently be stopped and the rollers must be cleaned by hand. Of course there are different cleaning systems, but – as many of our clients report – manual cleaning cannot be avoided and is still used.”

Aside from downtime costs for plant shut-downs, occupational safety is also a big problem in many companies.

“Clean” cooperation

The work group around Prof. Dr. Wolfgang Maus-Friedrichs, who works on surfaces and plasma applications at the Institute for Energy Research and Physical Technologies, Technical University of Clausthal, has developed some very special electronics. These electronics control a modern plasma. “We use modern dielectric barrier discharges, in which transient plasma discharges are ignited with very short AC voltage

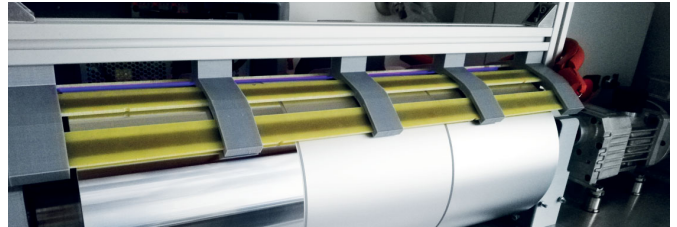

pulses. This generates a multitude of highly reactive species in these plasmas. With these species, organic contaminants can be broken down with reactions into gaseous components such as CO₂ and H₂O and be emitted into the ambient air in a safe and eco-friendly manner. The cleaning effect is highly efficient and scientifically proven.

For sizes required for roll applications, DBD's are easier and safer to handle than e.g. Corona plasmas. Compared to only point-acting corona plasmas, the DBD plasma also offers a flat and very homogeneous treatment option. Direct treatment in DBD plasma also sediments fewer by-products, especially ozone. The few that can arise is vacuumed in a controlled manner. Thus, the negative influence of ozone to the hard chrome layer of the roll surface is eliminated.

Derichs is now developing a gadget which can be placed as an angular segment on the area of the roller(s) which is not wrapped by the film, and with which this highly technological plasma will clean the roller surface in a controlled manner. The challenge here is to take into account the requirements of production and environmental parameters as well as the requirements that the plasma needs for an ignition. Fitted with different sensors, this gadget later monitors the roller from the outside. “We envisage that, along with our own function control, we can monitor the cleaning effect, the degree of contamination and – as a side benefit, so to speak – the surface temperature of the roller; so the Krefeld ladies mention unison.

First presentation planned

At ICE Europe 2019 in March in Munich, Derichs will be presenting the first results of this development. Interested visitors are invited to convince themselves of the exciting ideas of the two ladies. Stephanie Holzmann predicts: „It will definitely be ‚high-tension!’“

Hall A6, Stand 654

DERICHS GmbH
www.derichs-gmbh.de

KÜNDIG CONTROL SYSTEMS at ICE Europe 2019

Filmtest 3G – Offline Quality control for Films

The Filmtest is an offline measuring system for extruded films, used for process optimization and quality control labs. The combination of several measuring functions in an offline system makes the Filmtest a valuable tool for a professional quality control. Due to fast and easy handling it is practical to perform measurements at every roll change. Consistent measurement means you can provide your customer with more assurance that delivered production is within specification.

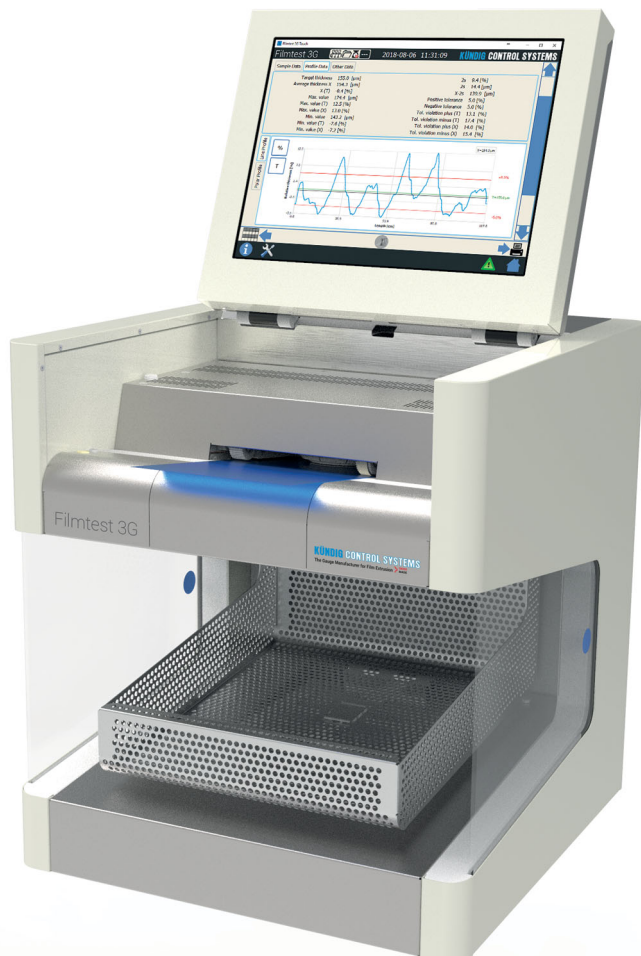

The operation of the system is easy enough that any operator can do it. The Filmtest helps to reduce the work in the laboratory. For example, in addition to the thickness measurement, the unit weight of the sample is also calculated eliminating the manual step of weighing the film.

The Working Principle

- A sample of the film is cut by means of a cutting plate, that guarantees that the exact width of the sample is 150mm.
- The „Variospeed“ sample scanner uses optical sensors to track the film edges; automatically transporting the sample through the capacitive measuring device.
- The length and the weight of the sample is measured.
- The square meter weight is determined using length, width and weight, then the average thickness is calculated based on the density.
- The thickness profile is measured by a high-resolution capacitive sensor.

Advantages

- The sample of the film does not need to be formed into a loop, it will be transported through the capacitive measuring device.
- Film samples that are cut into several pieces can be measured one after the other, the software will put the measuring data together and will create the complete profile.
- The square meter weight is determined using length, width and weight. Then the average thickness is calculated based on the density. This method allows a much more precise thickness profile measurement than other systems on the market.
- All measuring values will be registered during the same measuring operation.

Hall A5, Stand 1010

► Kündig Control Systems
 gauge.ch

The infrared wide band sensor FR 61

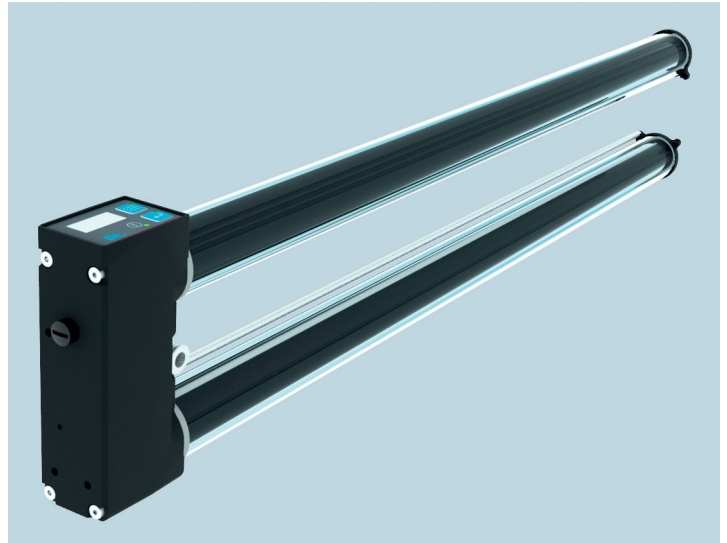

Erhardt+Leimer at ICE Europe 2019

New edge sensor with extra wide measuring range

At ICE Europe (12 to 14 March, Munich, Germany), Erhardt+Leimer will present new and proven products from the sector of measuring and automation technology for the converting industry.

Measuring range three times larger than before

The new digital infrared wide band sensor FR 61 is particularly suitable for the precise acquisition of the position of homogenous, opaque materials. Even transparent materials (transparency of up to 70 %), e.g. cloudy plastic films can be detected.

The particular advantage of the sensor is its large measuring range: 3 variants with measuring ranges of 160 mm, 320 mm and even 480 mm are available. The web can be acquired and guided in the entire sensor field of view. Format and width changes during production can be undertaken reproducibly, quickly

and cost-effectively because the manual adjustment of the sensors required in the past is no longer necessary. It is also possible to evaluate up to 4 edges simultaneously.

The actual edge position and diagnostic information are displayed on the sensor's integrated display. The Ethernet interface on the device and an integrated web server make possible servicing and access to status values, warnings and alarms as well as the complete configuration using a standard web browser.

The wide band sensor operates with the transmitted light principle. Due to the overlapping arrangement of individual infrared light paths, there is a correspondingly large measuring range with a high resolution of 0.01 mm and high linearity.

An integrated exposure controller largely compensates for effects such as external light and soiling. Optionally, the sensor is available with an air purge system.

Triggered scanning of color lines or other contrast features

With the proven FE 52, E+L will also present a color line sensor with a trigger mode such that web guiding based on a single criterion directly in the printed image is possible. This individual criterion can be a color line or a contrast feature, for example an individual letter. As such, technical orientation lines used only for web guiding and cut off after the printing process are no longer required.

Along with the sensors, Erhardt+Leimer will present at ICE its systems for web guiding, web tension control and the measurement of the weight per unit area and the thickness of coatings.

Hall A5, stand 1110

Erhardt+Leimer GmbH
www.erhardt-leimer.com

GOEBEL IMS at ICE Europe 2019

Tailor-made Machine Concepts for Demanding Applications



To ensure perfect pressure control, the XTRASLIT 2 was equipped with a rubber coated contact roller that counterbalanced higher pressures for excellent finished roll quality

GOEBEL IMS, one of the world's leading manufacturers of slitting and winding solutions, presents its broad portfolio of innovative machines for high-quality converting of film, paper and aluminum foil from March 12th to 14th at ICE Europe in Munich, Germany.

Special films, such as battery separator films, condenser and optical films, constitute a seminal market to which GOEBEL IMS has been the foremost supplier for many years with its extensive product range of customized machines.

One of them is the XTRASLIT 2, offering outstanding efficiency and winding quality in the converting of films, papers and flexible packaging materials. Thanks to its modular machine concept and many individual technical features, the XTRASLIT 2 covers almost any customer requirement and can be configured as requested.

GOEBEL IMS is a globally valued manufacturer of innovative slitting and winding solutions both for manufacturers and converters for paper and board,

film, tobacco paper, alufoil and aseptic packaging and other special materials. The range of products include slitter rewinders and winding machines as well as special machinery for web materials. Innovative technologies, highest machine availability and quality are always in focus.

Hall 6, stand 344

GOEBEL IMS
www.goebel-ims.com

SML at ICE Europe 2019

Lamination Lines for Aseptic Packaging

With the development of the new triplex extrusion lamination line for aseptic board packaging, SML takes the production of aseptic materials for beverage cartons and flexible pouches to the next level.

Precise interaction for excellent product quality: In sharp contrast to nearly all existing extrusion lamination lines for aseptic board packaging, SML's new line is suited for processing thin paper as well as paperboard at an equally high quality. "Our new line offers a very wide application area – from antiseptic materials for classical beverage car-

tons to flexible pouches. Its essential characteristic is the very precise interaction between the different unwinding units and laminators, managing very different materials like paper, board and aluminium", explains Mario Hoellsteiner, the responsible product manager of SML

Automatic drum winder for heavy loads: Another technical highlight of SML's new triplex extrusion lamination line for aseptic board packaging is the fully automatic drum winder 1800, suitable for heavy product rolls up to four tons. Finally, the lamination line is setting new standards in automation and digitalisation - providing a central control station system for all production processes, remote operation, supervision and service, as well as interconnectivity with other machines and systems.

Combine the options and gain the edge – the SML triplex lines for aseptic packaging

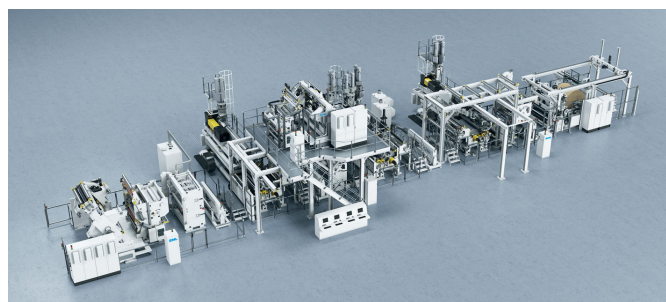

Hall A6, stand 740

SML Maschinengesellschaft mbH
www.sml.at

Eltex at ICE Europe 2019

Innovative Electrostatic Systems for Process Optimization

For more than 60 years, Eltex has been focusing on specifically targeting the use of electrostatics to optimize production processes and removing it where it has unwanted consequences. Electrostatic systems from Eltex enable higher production speeds, significantly increased quality, reduced energy consumption, fewer faults and minimized downtimes and spoilage.

Eltex POWER CHARGER – A new generation of high-voltage generators:

Higher quality, less energy consumption, faster production thanks to fewer disruptions, less downtime and less spoilage. Electrostatic charging does not always have negative consequences; when used for specific purposes it is downright useful in many areas. It is great to see that Eltex is setting new benchmarks in charging technology. User safety has been re-examined during the development of the POWER CHARGER. The generator will also be available in performance level D in the future. An entirely new plug system enables simple, secure contact with the inserted bars. Continuous refinement is bringing hardware and user protection to a higher level with each step.

Eltex flexION / flexION air discharging bar:

The newly patented AC discharging bar with a free-standing air-supported spring tip achieves a very high passive discharge effect, which enables active opera-

tion even at a low level of high voltage AC. A small amount of air can be blown through the hollow spring tip to increase the range and to continuously clean the emission tips.

The new flexION Eltex bar features excellent discharging results at low and maximum speeds. The special feature here is that the discharge performance remains constant from short distances up to large ranges. It is exactly this wide-ranging performance that characterizes the flexION as the only discharging bar in the world that can be used in different geometric situations – even in narrow, grounded machine environments.

MISTING TACKER for preventing ink mist and for the optimal particle deposit in printing and coating units:

During printing and coating processes, so-called ink mist or particle mist arise in the outlet of double-roll systems. This unwanted particle deposit results in lower product quality, high maintenance costs, increased ink consumption and the contamination of the environment. The formation of ink mist is very noticeable and annoying, particularly during coating and printing processes on substrates with non-absorbent surfaces (films, metalized substrates or composite films). A patented double-row DC plasma electrode is used to prevent this ink mist. This plasma electrode acts separately on both particle streams and ensures an optimal ink transfer. The electrode will be connected to the high voltage generator HSG61.

In addition to these novelties, Eltex also presents: Powerful Eltex Charging systems, efficient Eltex Discharging systems, Eltex ESA Printing Assist systems, and Eltex Remoistening systems.

Hall A5, Stand 1010

Eltex Elektrostatik Gesellschaft mbH
www.eltex.com

POWER CHARGER



MISTING TACKER System

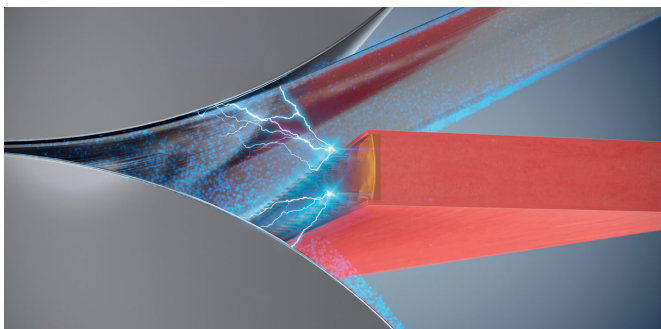

Nepata presents a world first at the ICE Europe: The Nepata DL1650 film separator allows for automatic separation of self-adhesive film on rolls (© Nepata GmbH)

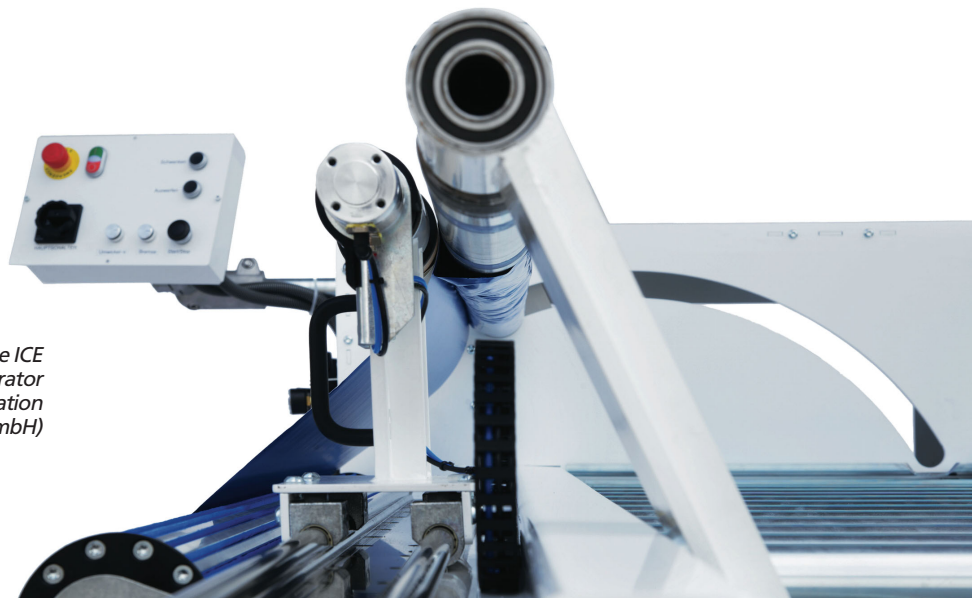

Nepata at ICE Europe 2019

Film Separators for Faulty Self-Adhesive Films

Nepata presents a world first at the ICE Europe: A machine that separates self-adhesive film from its carrier paper. This makes it possible to obtain recyclable, pure PVC from faulty film media. Furthermore, the manufacturer of specialized machinery will be displaying the current lineup of its rewinding, trimming and slitting machines, in particular its flagship: the UA 1650 ADWS precision converting center. Further improvements to the slitting head allow for even better slitting.

The Nepata DL1650 film separator is the first machine to allow for automated delamination of films. It thereby helps avoid plastic waste and expensive disposal. During the manufacture of self-adhesive films, the coating process, waste material is created. Thus far, the disposal of faulty film rolls was an costly expense.

Efficient delamination:

The newly developed machine separates a 50-meter roll in around two minutes. Rolls of up to 350 mm in diameter and 1,650 mm in width can be processed. The DL1650 separates the layers and rewinds PVC film and kraft paper individually. At the film side, this process is coreless, whereby pure material is generated. In addition, the designers paid particular attention to ergonomics and operator safety: A single machine operat-

ing around the clock can recover several thousands of tons of pure PVC each year. Like all of Nepata's film processing and converting machines, the DL1650 is 100% made in Germany. With its film separator, Nepata has applied for the ICE Award in the category of sustainability and environmental protection.

Better slitting:

In addition to this world first, Nepata will also be displaying its proven converting solutions at the ICE Europe. The UA1650 ADWS Converting Center, the 1900 ADWS slitting machine and the UA770 rewinding and trimming machine will be on display and live operation demonstrated. All Nepata slitting machines and converting centers (ADW/ADWS models) are now shipping with two new features that make them even more precise: A jaw lubrication system for the slitting head lightly lubricates the blade with silicone oil. The new line laser provided on the slitting head reliably displays the slitting blade's exact position on any film or paper surface.

Hall A5, stand 1936

■ **NEPATA GmbH**
www.nepata.de/en/rewinders/

Fraunhofer Institute for Applied Polymer Research IAP
at ICE Europe 2019

Much more than plastics

Hall A5, Stand 1174

The Fraunhofer IAP will present a new approach for inline monitoring of coating processes. Adding fluorescent dyes enables the monitoring of the thickness distribution of the entire coated area. Advantages: higher reliability, improved quality, reduced costs and process optimisation. The researchers will also present an antimicrobial food packaging film and news on flame treatment of plastics.

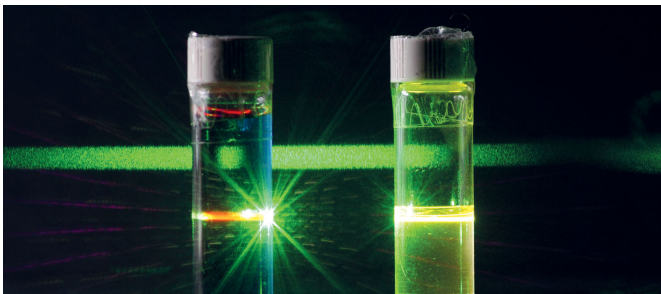

Fraunhofer Institute for Applied Polymer Research IAP
www.iap.fraunhofer.de/en/fraunhofer-iap.html

Fraunhofer Institute for Organic Electronics, Electron Beam
and Plasma Technology FEP at ICE Europe 2019

Evolution of Surface and Light

Hall A5, Stand 1174

Fraunhofer FEP's biodegradable films make it possible to connect flexible polymer films with biodegradable conductor traces. This innovation can be used to manufacture medical implants for use in pre-surgical epilepsy diagnostics. The complete dissolution of the foils including the conductor traces does not only protect the environment but also saves patients a second operation.

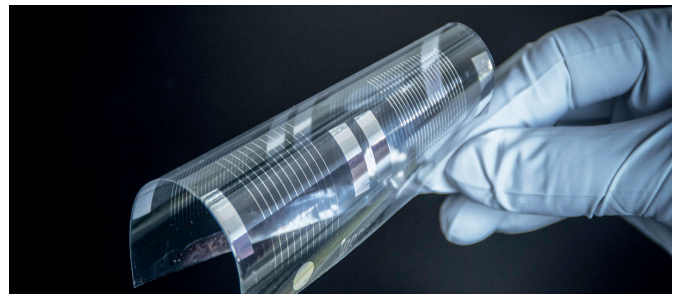

Fraunhofer Institute for Organic Electronics, Electron Beam
and Plasma Technology FEP
www.fep.fraunhofer.de/en.html

Fraunhofer Institute for Interfacial Engineering
and Biotechnology IGB at ICE Europe 2019

Innovations at Interfaces

Hall A5, Stand 1174

Fraunhofer IGB develops barrier coatings, oil, water, dirt or ice repellent coatings using gas phase processes (CVD, PVD, PECVD) and biobased formulations for multifunctional coatings, which can also be produced in roll-to-roll processes. For the control of the process steps and the characterisation of the material surfaces a variety of analytical methods are available.

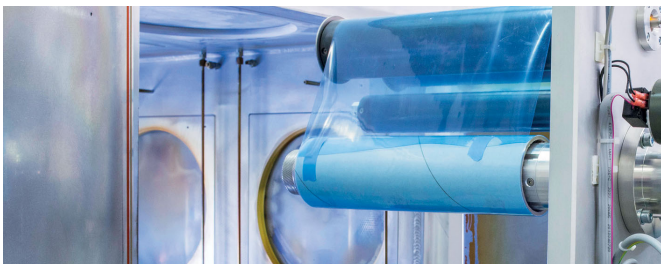

Fraunhofer Institute for Interfacial Engineering and
Biotechnology IGB
www.igb.fraunhofer.de/en.html

Emmendinger at ICE Europe 2019

When Power meets Precision

Hall A5, Stand 1154

EMB cross-cutting machines are successful all-rounders for film manufacturers and confectioners. Even at high speed, tailor-made cuts are guaranteed with the highest quality. Unwinding in various designs, web edge control, longitudinal cutting units for edge trimming and multi-purpose formats are optionally possible. Different film materials with thicknesses of 10µm to 1.500µm can be processed.



Emmendinger Maschinenbau GmbH
www.emmendinger.de/en/

Dienes at ICE Europe 2019 The Perfect Slit

Hall A6, Stand 500

DIENES, a leading supplier of industrial slitting technology presents products such as circular and straight knives, knifeholders and slitting systems next to technological innovations such as: electrically driven knifeholder for cutting widths from 70 mm, alternative drive concepts and maintenance options for automatic slitting systems, and shear cut knifeholder DS 8 with tool-free knife change.

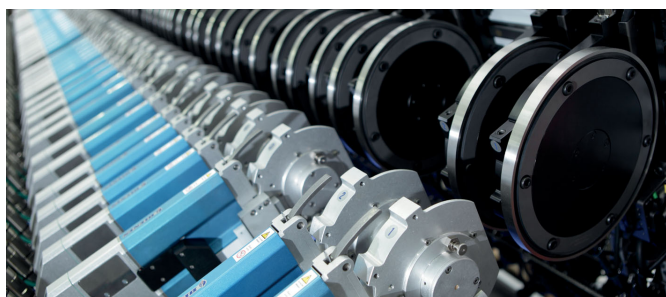

■ Dienes Werke GmbH & Co. KG at ICE Europe 2019
www.dienes.de/en/

DAVIS-STANDARD at ICE Europe 2019 Equipment and Services tailored to Exact Needs

Hall A5, Stand 1310

Davis-Standard supplies equipment for solution and extrusion coating systems using advanced extrusion, coating, winding and controls technology. This technology is available for retrofit, the company specialises in the upgrade of control and mechanical systems for web coating and converting. They have facilities in the United States, Canada, China, Germany, Finland, Switzerland and the United Kingdom.



■ DAVIS-STANDARD, LLC
www.davis-standard.com

BST Eltromat International at ICE Europe 2019 Quality Assurance Systems

Hall A6, Stand 480

BST eltromat will show quality assurance systems especially for the coating and converting industry at ICE Europe. News e.g. in the field of web guiding or register control, will be shown in Munich. Of course, visitors can get comprehensive information about the whole product range of BST eltromat and the BST ProControl business unit.



■ BST ELTROMAT INTERNATIONAL GMBH
www.bst.group

KAMPF LSF at ICE Europe 2019 New Film Converting Plant

Hall A6, Stand 710

Kampf LSF presents a new film converting plant (coating with UV curing lacquers) which is sold under the brand name UltraCoat. With this plant super matt and no finger print surfaces can be manufactured. Furthermore, the company introduces a new slitting machine for electrode coils in the Lithium Ion Technology (EvoSlit).



■ KAMPF LSF GmbH & Co. KG
<http://lsf-maschinen.com/en/>

Dr. Collin at ICE Europe 2019 Pilot and Laboratory Lines for the Plastic Processing Industry

Hall A5, Stand 1670

Collin develops intelligent, modular pilot and laboratory lines for the plastic processing industry and research institutes. Collin solutions are used for the development and production of plastic products, material tests up to pilot tests, which allow an upscale to production scale.



Dr. Collin GmbH
www.drrollin.de/en/

Mahlo at ICE Europe 2019 Quality control systems

Hall A5, Stand 1510

Mahlo is one of the worldwide leading manufacturers of measurement and control systems for the coating, film and paper sector. At ICE Europe 2019, the company showcases the quality control system Qualiscan QMS as the perfect tool to determine and manage important parameters such as thickness, basis weight, coating thickness and moisture online.

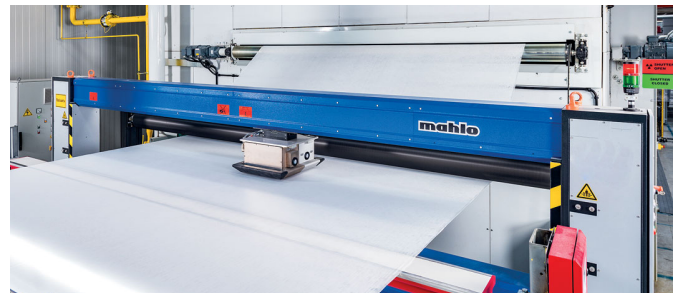

Mahlo GmbH + Co. KG
www.mahlo.com

ASSURING QUALITY FOR CONVERTING



Hall A6, Booth 480 &
Hall A5, Booth 1774



Visit us:
www.bst.group



Photos of The Bullet II, showing the absence of hardware, i.e. nuts and bolts, so disassembly, cleaning and restart are made easier



“THE BULLET II” Extrusion Head

Guill Tool introduced The Bullet® in 2015, a new extrusion head with fixed center design, multi-port spiral flow design and gum space adjustment, plus the added feature of no fastening hardware, so cleaning and restart are easier and faster than any conventional head on the market currently, according to company sources. The company announces the next generation of this unique and patented tool, The Bullet II.

The Bullet II allows quick tooling changes, as the tips remove from the back and the die removes from the front of the unit. The absence of fastening hardware eliminates leaking, as does the taper body and deflector design pioneered by Guill. Additionally, the new patent pending CAM LOCK® deflector retaining system offers these additional benefits to extruders and machine builders:

- It only takes ½ turn of the Cam Lock® to remove and install the Deflector and Tip

- No fastening hardware required
- Fast tool changes, threaded retaining ring for the die and threaded tip retainer
- Dies are removed from the front and tips from the rear
- Tooling retainers also provide gum space adjustment
- Hassle free air / vacuum connections
- Simplified cleaning
- Reduces downtime and lowers operating costs

High- and low-volume applications are suitable for this head and are accommodated with the simple, easy changing of just one component. A family of cross-head designs is available and users can specify the “caliber”, that is, the max. die ID.

A vacuum chamber and kit for assembly and disassembly are included with the unit. Optional keyed tooling capability offers machine designers and end users quick orientation, so the overall unit design enables faster disassembly, proper cleaning and re-

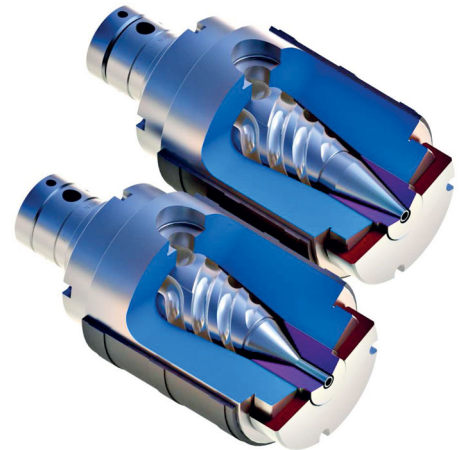

start, allowing the line to become more profitable, more quickly.

For a video demonstrating this new design, please visit: <https://www.youtube.com/watch?v=MpEdmCRtaqg>

Guill Tool & Engineering
10 Pike Street, West Warwick,
RI 02893, USA
www.guill.com

State-of-the-art data acquisition, processing and analysis can significantly simplify the daily production routines of compounding companies and provide valuable in-depth information for process optimization. This is why Hannover-based KraussMaffei Berstorff GmbH offers two highly innovative solutions for all twin-screw extruders of the new ZE BluePower generation. This enables perfect integration of advanced compounding equipment with Industry 4.0 technologies



Process data acquisition system for KraussMaffei Berstorff twin-screw extruders helps to fully utilize the optimization potential

Industry 4.0 Solutions for Compounding Extruders

Process-data acquisition provides full control at all times

In order to meet the ever increasing demand for data acquisition and analysis, KraussMaffei Berstorff has developed two new systems, which are now available as options for ZE BluePower extruders. The first of these developments is designed to synchronously collect all production data of a compounding line. It is composed of perfectly tuned hardware and software components for acquisition, recording, evaluation and further processing of all process and measured values. Data analysis provides a sound basis for process optimization, in particular when it comes to process modifications or planned quality improvements.

Thanks to its modular design and easy configuration, the system can be adapted to a wide range of different applications, scaled in size and is suited for interface-independent operation. All interfaces can be integrated into an overall system that collects and visualizes the desired process data. Pressure, temperature, speed and volume flow values of all upstream and downstream components – e.g. metering systems, melt filters, melt pumps and pelletizing systems – as well as the extruder parameters are combined in a single system.

The ZE BluePower series of KraussMaffei Berstorff is prepared for data acquisition and analysis



Color measurement gives constant melt quality

The second development for in-line process monitoring is designed to detect instantly any metering errors in order to reduce production scrap and enhance line efficiency. This in-line measuring system is based on color measurement: light is projected into the melt, reflected and then detected by a high-resolution glass fiber sensor. Upon comparison with the previously defined setpoint, any deviation in terms of brightness or color is instantly recognized and indicated. It goes without saying that the color measuring system can be integrated into the overall line control.

Highly profitable compounding extruder

The ZE BluePower twin-screw extruder series is characterized by high energy efficiency, uncompromising safety at work, simple use and low maintenance efforts. It perfectly meets the ever increasing requirements of compound processors in terms of flexibility and cost effectiveness. Thanks to the unique interaction between the 1.65 OD/ID diameter ratio and the specific torque of up to 16 Nm, volume- and throughput-limited formulations can be compounded on a single machine. The special highlights of the ZE BluePower extruders are oval liners, improved side feeders and degassing units as well as the optional energy management tool. The 4D and 6D barrel sections that can be combined with the extensive range of modular screw elements to create bespoke machinery configurations for any application are simply unique in the market.

KraussMaffei Berstorff GmbH
An der Breiten Wiese 3-5, 30625 Hannover, Deutschland
www.kraussmaffeiberstorff.com

Like plastics manufacturing and processing, the recycling of plastic products requires specialization to be efficient. Accordingly, the Dutch company DALY Plastics has dedicated itself entirely to the recycling of agricultural films and packaging films from transport logistics. Currently, the processing volume rates 35,000 tons per year. DALY Plastics when processing film-flakes relies on the machine technology of the Upper Austrian company "MAS-Maschinen- und Anlagenbau Schulz GmbH". Three extrusion lines are currently in operation, a fourth is presently being commissioned



Image 1: The Dutch plastics recycling company DALY Plastics processes 35,000 t of agricultural films and pallet shrink films per year into gray, black and tea-colored polyethylene re-granulates for the reuse in blow film production (All images: TECHNOKOMM)

With the Right Choice to Success

The Daalder family in Zutphen in the Dutch province of Gelderland is already in the second generation in the collection of recyclables. It all started with Simon Daalder B.V., who

professionally collected waste paper and cardboard boxes and sold them to paper mills. At the age of sixteen, Peter Daalder, the practical oriented son of the founders of the company,

recognized the potential of plastic collection in 1985 as an opportunity for founding his own company. That same year, he urged his parents to drop out of school and set up his own

Image 2: The Daly Plastics collection system ensures the continuous supply of raw materials with agricultural films and commercial films largely separated by type and quality



Image 3: The film bales are dissolved at DALY Plastics. They then go through a sorting process that eliminates foreign material and separates the films into color classes or material quality. This is used to produce unmixed bales, which are processed into granules in the recycle plant

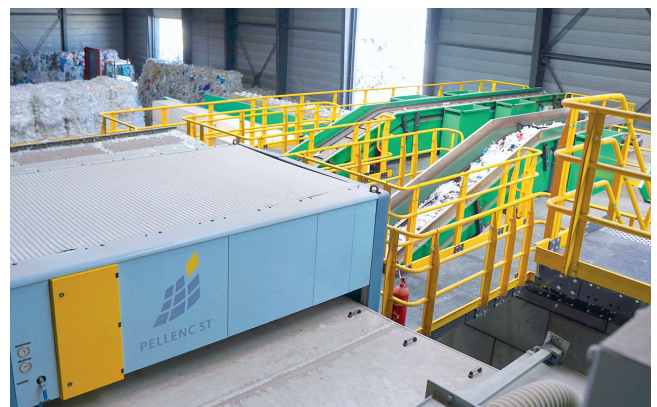

business. With the promise of completing his degree at evening school, he was hired in his parents' company. Since some of his parents' customers had in addition to cardboard to dispose films, and the youngster was able to offer the related collection service, his business under the name „Daly Plastics“ was well received. For the next 25 years, it remained in collecting plastic films, compacting them to bales and selling them. In this context, selling meant generally speaking exporting, especially to China. The export business developed very well, because processing to regranulates was a welcome new industry there. Accordingly, during these 25 years the PRC has become the largest recycling center in the world. To take those dimensions into account: In 2016, the PRC imported around 7.3 million tons of plastic waste worth US \$ 3.7 billion, which corresponds with 87% of all plastic waste from the EU. (Source: NTV online from 09.01.2018)

From the plastic collector to the recycler
 Asked about the motivation to change the company strategy after 25 successful years as a plastic-waste collection company and exporter, company founder Peter Daalder looks back: "For a long time, like most of our competitors, we simply followed

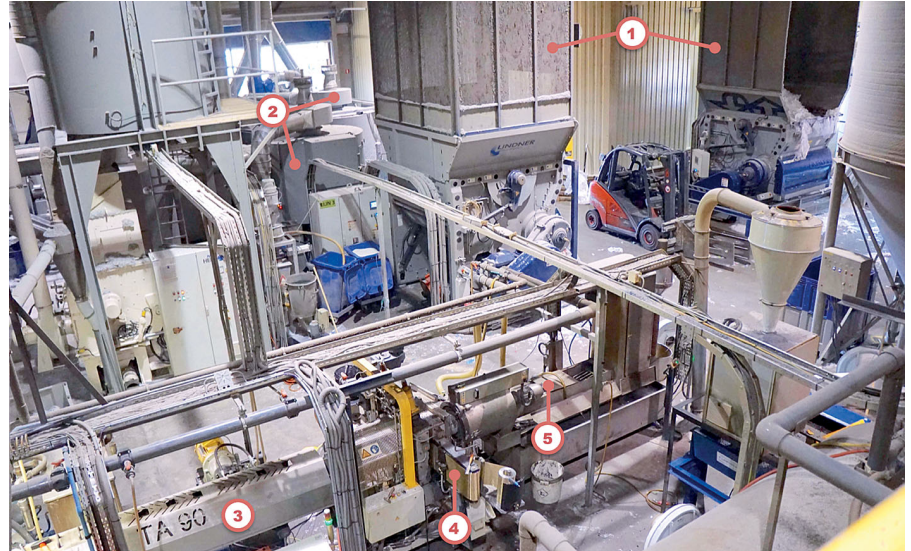

Image 5: The cleaned and dried film flakes pass through buffer storage to the MAS cascade extruders (1 = bale shredder, 2 = DRD double rotary disc dry cleaner, 3 = extruder 2 of a cascade extrusion line, 4 = fine filtration, 5 = granulation)

the market. Unrivalled low labor costs in China made recycling in Europe uneconomic. On the other hand, our location near Europe's most important seaports provided favorable conditions for cost-saving transport to Asia. Thus, a large part of the post-consumer plastic collected by us was exported. Doubts about this business model then came up in 2011 when one of our customers decided not to export everything anymore, but to start with an own processing of old agri-

cultural films and in this connection carried out processing trials at MAS-Austria. This made us aware of MAS. As a result, one day the opportunity arose to spend an evening with MAS founder founder Helmuth Schulz. We philosophized about the future of the recycling industry. He warned against an unwavering belief in the wage cost advantage in combination with low environmental requirements. If the next 5-year plan would define changes, the boom would be

Image 4: The un-mixed film-bales are processed into film flakes in granulators, which are then fed batch wise to MAS DRD dry cleaners where granular soiling and moisture are removed



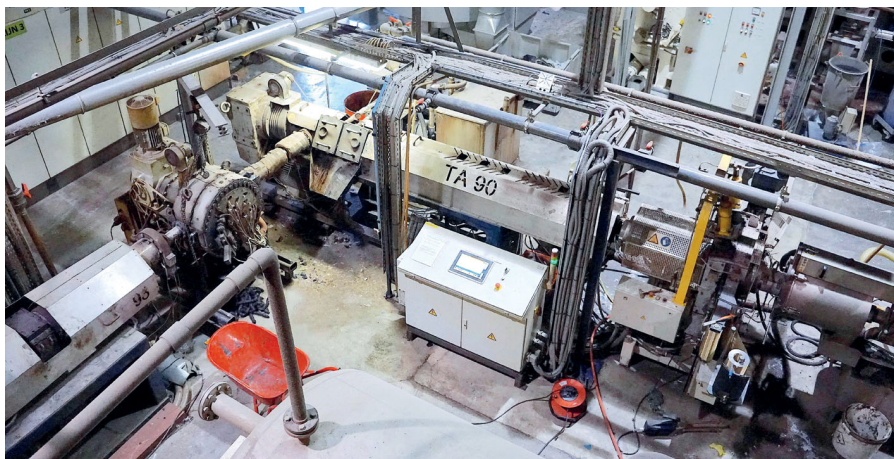

Image 6: Partial view of one of the three operating MAS cascade extruders. From left to right: MAS 93 extruder, MAS disc filter, MAS TA90 extruder with subsequent fine filtration system and granulation

over. The consequence for Europe must be a turnaround to higher plastic recycling rates. Looking back, I am glad that I was impressed by his arguments. From that day on, I prepared myself mentally for self-processing and started it in 2013. The prophecy of Helmuth Schulz, who died in September 2017, came true on January 1, 2018, when China closed its borders for used plastics with more than 0,5% impurities closed. This has torn deep holes in the balance sheets of plastic exporters with no in-house processing. Since we were already processing a large part of our collected plastic volume ourselves at that time, we were only marginally affected.”

Errors drive you smart

However, before the concept was up and production could begin, a number of opportunities had to be taken and technical points set. A major argument for contacting MAS was the waterless DRD (Double Rotary Disc) dry cleaning system. Because Daly Plastics intended to get along without a wet-washing process and the related expensive sewage sludge disposal when processing agricultural films. Since mainly granular soil particles and moisture had to be removed, attempts were made with the waterless DRD (Double Rotary Disc) dry cleaning system of MAS, which proceeded satisfactorily. In the meantime, Daly

Plastics relies entirely on MAS machine technology when processing pre-sorted and flake-finished films. The cleaned film-flakes can be processed on the MAS cascade extrusion line, consisting of the conical co-rotating twin-screw extruder MAS 93 (Image 1), a TA-90 single-screw extruder and a continuous disc filter between the two extruders to high-quality granules.

But a short time after the plant went into operation a Daly Plastics customer for plastic waste changed his strategy. Instead of continuing with processing agricultural films on his MAS recycling system, starting in 2013

food packaging films should be processed, as this promised higher sales revenues. However, it turned out that the DRD-dry cleaning process can only separate a small proportion of food fats adhering to the films. This limited the throughput at the extruder, whose degassing system managed to “degrease” the plastic melt only up to a throughput of 350 kg/h – one third of the maximum output. The conclusion was that it would not work without changing the concept.

Specialization as a success factor

Now – it was the year 2013 – struck the hour of Peter Daalder. He bought the two DRD and after a call to MAS boss Schulz, who acted as a middleman, the cascade extruder and accessories. Thus, the technical conditions for the founding Daly Plastics sister company Caroda Polymer Recovery (named after Peter Daalder’s daughter Caroline) were given. The commercial basis was the decision to specialize in the future on the processing of agricultural and industrial films (= pallet over-packaging, with a high proportion of LLDPE shrink films) (Images 2 and 3).

The Caroda polymer plant after some optimizations and with the support of MAS hit the ground running very well. Above all, the filter technology had to be optimized: Finally between the extruders of the cascade a contin-

Image 7: MAS sales engineer Gerald Badegruber and DALY Plastics shareholder Peter Daalder, visibly satisfied with the long-term performance of the MAS systems, the first of which has been running for more than 30,000 hours in 4-shift operation



uously working disc filter (type: MAS CDF 500-D) separates particles down to 250 µm and a second filter after the second extruder all impurities down to 90 µm. In this constellation, the system, supplied by two DRDs, reaches an output of up to 1300 kg/h (Images 4, 5 and 6 and Factbox MAS recycling technology).

When an English recycling company ceased operations due to economic problems, Daalder acquired a second MAS-93 cascade line and purchased two more DRD dryers. A short time later, he invested in the third MAS-line, achieving a total annual production capacity of 33,500 t of polyethylene granules with an MFI of 0.4 to 1.4 g/10 min (190°C and 2.16 kg) for blow molding applications in the colors gray, black and light brown, referred to as "tea color". The recycled materials have a high tensile strength and are suitable for the production of tear-resistant garbage bags and drawstring bags.

Expectations fully met!

Looking back on three years of practical experience, MAS technology has fully met the expectations set in it. Peter Daalder again: "Not only the output and the stability of the production system has met our expectations, but also the long-term performance, after all, our systems are operated around the clock in a 4-shift system. Our first line has now completed more than 30,000 hours without major problems (Image 7). That motivated us to invest in the fourth plant, which has gone into full operation by the end of 2018. Overall we see an approval of our approach to rely on the local production of recycled granules. We want to continue on our path by expanding our offer to recycling natural-based plastics as well as PP, PS or PS impact-resistant. By 2020, we want to expand production capacity to 100,000 tons per year. Because in Europe the recycling-future has just begun."

Author:
Reinhard Bauer - TECHNOKOMM
office@technokomm.at

MAS recycling technology

Cleaning principle

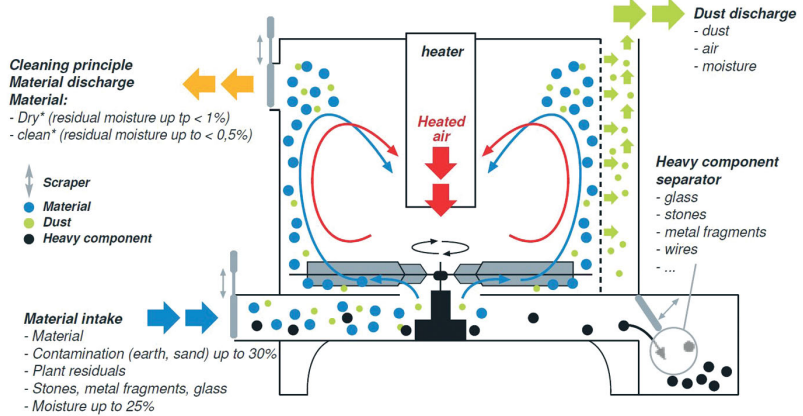

Image 1: The functional principle of the MAS dry cleaning system for film flakes: The batch-wise processed film flakes are forced through a 2-stage rotor into a turbulent warm air flow. In the process, moisture is separated off and dirt particles are detached and separated by centrifugal force due to the resulting frictional heat

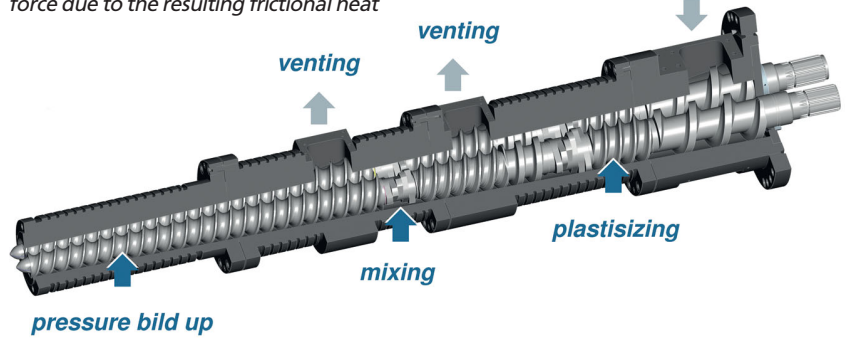

Image 2: At the heart of the MAS extrusion technology is the conical twin-screw extruder with co-rotating screws developed by its founder Helmuth Schulz. Advantages of this type of extruder are the large feed opening, which allows the efficient intake of raw materials with low bulk density, as well as the low-pressure plasticization – both prerequisites for gentle recycling

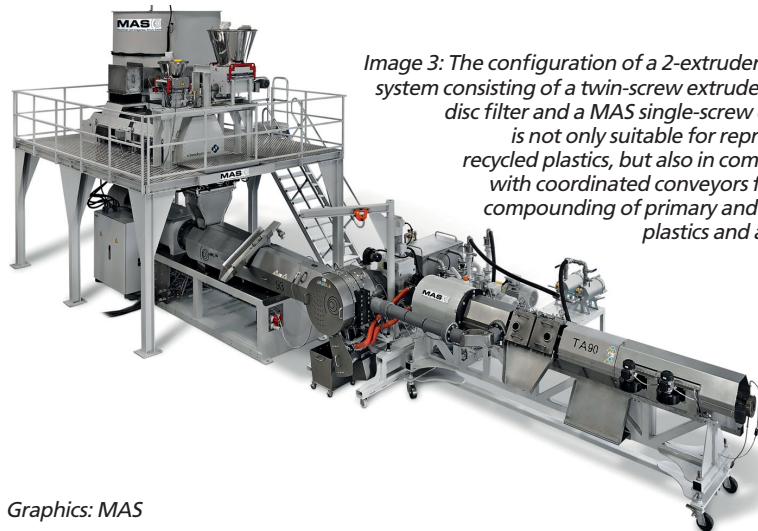

Image 3: The configuration of a 2-extruder cascade system consisting of a twin-screw extruder, a MAS disc filter and a MAS single-screw extruder is not only suitable for reprocessing recycled plastics, but also in combination with coordinated conveyors for direct compounding of primary and recycled plastics and additives

Graphics: MAS

MAS Maschinen- und Anlagenbau Schulz GmbH
A-4055 Pucking, Austria
www.mas-austria.com

DALY Plastics Plasticrecycling BV
Industrieweg 101a, NL-7202 CA Zutphen, The Netherlands
www.dalyplastics.nl

Five Stars for Brabender

With its 5-Star Service, Brabender strives to keep downtimes as short as possible and the customers' operating costs low. The German lab equipment manufacturer, based in Duisburg, is offering a number of additional benefits in the category of "Value-Added Services". The company's principle, "where quality is measured", not only fits perfectly to the material testing equipment but also to Brabender's services

Whether laboratory mill, rheometer, viscometer or extruder: Brabender ensures the operability of its equipment for well over 10 years through the right spare parts.



Service over the course of the entire instruments' lifetime

"We deliver more than just devices," jokes Kai Kunicke with the humor that is typical for the Ruhr region. With a wink, the Director of International Service at Brabender refers to the extensive service area of the highly traditional company. "With our customer service, we want to be able to guarantee that our customers will get measurably high availability of their Brabender equipment. To this end, we feature various offers and are also develop-

ing new ones, partly with our customers." The Brabender 5-Star Service includes five service areas that are all closely intertwined.

Star 1: On-site service – prevention instead of standstill

Inspection, maintenance and repair – Brabender offers these services at its customers' locations. Kai Kunicke clarifies: „The worst case is when the device won't work at all or no longer works flawlessly. This results in a standstill, necessary replacement parts have to be procured and the device must be repaired. This is why we take the precaution of replacing components when they are close to the end of their lifecycle. Sometimes this depends on the condition, but we also do this according to plan. That is how we avoid or minimize possible downtimes which might result in significant follow-up costs for the customer. If you make well-considered provisions, you can avoid a standstill."

After every inspection, maintenance or repair, Brabender service technicians write a detailed maintenance report that can be archived 1:1 in the equipment log kept for the test equipment management. "We have over 60 partners worldwide, most of whom also have their own service personnel with workshops. All in all, our 5-Star Service spans a tight net across the globe," says Kai Kunicke.



*Kai Kunicke, Brabender
Customer Service
Director*

Star 2: Replacement parts – using devices for the long-term

Brabender has continued to improve the logistics of its replacement part division over the years. „Our customer service represents a replacement part supply that goes far beyond the ten years expected on the market. Our customers also get replacement parts for devices that are 20 years old or more,” Kunicke says proudly, for good reason.

Customers of the lab equipment specialist can trust in professional consultations as well as the quick selection and delivery of the required part. As the central contact point, the employees of the 24/7 service line help with the organization of original replacement parts and consumables from the start.

To expand a device’s range of functions or bring it technically up to date, Brabender offers upgrade kits. „They are a solution for staying operational when suppliers have canceled replacement parts,” Kai Kunicke adds. “With our replacement part service, our customers benefit from the long-term usability of their device and a predictable parts supply over many years.”

Star 3: Service line – 24/7, always available

To keep the downtimes of devices as short as possible, the customer service can always be reached – 24 hours, seven days a week. If there is a problem, the service line employees get all the gears moving to solve it for the customer quickly and conveniently.

As personal representatives, they support customers with the diagnosis and finding a solution, as well as in the selection and procurement of the required original replacement parts and consumables. The employees of the 24/7 line are also involved in the coordination with the Brabender experts in Research and Development and in the organization of service assignments – whether this is through remote maintenance or personally at the customer’s site. “Of course there is also the option to schedule a guaranteed response time with us,” Kai Kunicke explains. “This happens as part of a service agreement. It clarifies that we can only implement this if the accessibility is given.”

Star 4: Factory service – sophisticated rejuvenation

Every device must be overhauled at some point. Then employees of the factory service at Brabender’s service shop repair the defective parts. They use original parts from Brabender in this process to extend the lifespan of the devices while also maintaining their value.

„When we complete the services on our premises, the customers won’t have to



The Brabender 5-Star Service embraces the areas On-Site Service, Spare Parts, Factory Service 24/7 Service Line and Value Added Services

pay the sometimes significant travel costs of a service technician. Wherever possible, we provide a loaner device so that work can continue without interference during that time,” the Service Manager Kunicke says about the Brabender Factory Service. “We’re not just speaking about a repair but also a sophisticated rejuvenation of the devices. If needed, our specialized department will also install new wiring and, if desired, apply a new finish.”

If customers have older devices for which Brabender no longer has replacement parts in stock, Brabender offers a production according to the original drawings. Kai Kunicke adds: “In the end, we hand the customer an overhauled and operational device with a functionality and measurement ranges that largely meet the specifications of its construction year.” This is extremely invaluable: all the data collected on the device by the customer with measuring methods that have been customized over the years can be used just like before.

For measuring devices that are no longer needed but still functional, Brabender has set up the free sales platform Brabender Marketplace. All you have to do is register. This way the company wants to contribute to sustainability (see info box).

Brabender Marketplace

Online exchange for used devices

Purchases and sales exclusively of used laboratory measuring devices made by Brabender and other manufacturers: Buyers can browse all the clearly arranged offers without obligation and at their leisure. If there is interest, the Marketplace provides the seller’s contact information. There is no commission. The purchase agreement is executed only between the seller and buyer.

Sellers use the entry screen on the Marketplace to conveniently set up their device. The sale through the Brabender Marketplace is free.

Learn more:
<https://bit.ly/2SFwsaF>

Star 5: Value-added services

With a series of other benefits, Brabender offers added services that are truly special. Customers who want to go easy on their budgets and still test the condition of their devices within the defined timeframe can utilize Brabender's inspection and maintenance contracts. "A regular check-up ensures constantly correct measurements that are necessary for a flawless, continuous production process," is how the Brabender Service Director describes the high benefit of the maintenance contracts. "In the end, the customers can then avoid partially significant expenditures for handling complaints, not to mention damage to their reputation and image."

Individual or standard – reliability is what counts

Brabender customers can decide individually in which scope and how often the maintenance and inspections should take place. „We generally provide solutions that follow the needs of the customers. The smallest service we can offer is an inspection. This can be upgraded to the Standard Preventive Service (SPS). In this process we replace parts, calibrate and perform control measurements. This package in turn can be expanded to include emergency responses with the Premium Service (PS), and with a guaranteed replacement device and short response time to the Full Premium Service (FPS). Everything can be combined – exactly as the customer wishes. For new devices, of course, this also includes an extension of the guarantee with an optional warranty extension," the Service Director Kunicke explains.

In the cycles for preventive maintenance, the Brabender 5-Star Service also shows flexibility: whether on a quarterly, semi-annual or annual basis – in addition to these customary repetitions, agreements with a two-year interval are available. Kai Kunicke knows the benefits: „If you have a maintenance contract, you can specifically plan the costs for each budget year. Many customers often have separate budgets for such expenses. The budget for repairs can then be freed up. "

As part of a maintenance contract, customers can get updates for the Brabender application software. The benefit is obvious: this avoids incompatibilities and the device's evaluation possibilities are improved. As an add-on for preventive maintenance, the Brabender service team offers emergency responses and remote maintenance. Both can be added to a maintenance contract for a fee.

Calibration Kit – reference material for food and chemistry

The so-called Brabender Calibration Kit is a special "service". Brabender customers can use it to compare the projected and actual values on their devices by themselves. It consists of reference material, procedural instructions and the measurement result of this material as a reference that was obtained on master machines. They are used only

To ensure functionality, Brabender offers reference material for its various devices



for this material and must always deliver the same results. This means that anywhere in the world, devices that are tested with this reference material correspond with the master device, the "original meter". If this is ever not the case, the customer can discuss possible solutions directly with the customer service. From the measurement results, in turn, the Brabender service employees can draw important conclusions about the condition of the device. At the same time they receive a catalog of procedures to return the device to the required condition. Regular checks with the Calibration Kit are possible for various devices in the food and chemical business areas and are easy to perform. It's worthwhile: if it goes well, the control measurements prevent expensive complaints, unnecessary waste or even damage to the company's reputation. In the end, we understand the sentence "We deliver more than just devices" very well. The Brabender 5-Star Service offers comprehensive services throughout the entire lifecycle of the devices. Even in case of complex problems, the experienced and competent service technicians always strive to help as quickly as possible. This deserves five stars, in the truest sense of the word.

Learn more about the Brabender 5-Star Service:
<https://bit.ly/2QO1sla>

Watch the Brabender 5-Star-Service video:
<https://youtu.be/Lmige5IAGw>

Brabender® GmbH & Co. KG
 Kulturstr. 49-51, 47055 Duisburg, Germany
www.brabender.com

Russian Mining Chemical Company LLC (RMCC) is expanding its range of high grade magnesium compounds and announces the launch of high active magnesium oxide production. The product is manufactured at the recently opened third processing plant in Vyazma, Smolensk region, Russia, and is marketed under the MagPro® trade name



Launch of high active magnesium oxide production

MagPro® is manufactured on a new calcination line constructed in Germany. The line designed according to the latest innovative technologies ensures a consistently high quality end product.

Micronized grades of magnesium oxide are most widely used in the production of halogen-containing synthetic rubbers. In particular, MagPro® is used as an inhibitor of premature polymerization, an acid acceptor (HCl) during the production of synthetic rubber. In SMC and BMC production it acts as a thickener in premixes and prepregs.

Using MagPro® in rubber products manufacture has many advantages, as MagPro® is a natural product obtained by indirect calcination of high quality brucite from the company's mining operation site in Kuldur. This technology helps to avoid contamination of the magnesium oxide with the residues of fuel combustion and also prevents overheating of the product which would have caused its activity decrease.

MagPro® has a precisely defined particle size distribution and a specific surface area of more than 140 m²/g. Thanks

to the state-of-the-art technology for selecting raw materials by X-ray radiometric separation of ore, MagPro® has a very stable chemical composition. Moreover, due to its mineral source it does not contain any volatiles like chlorides and sulphates. All these features help MagPro® to provide the same or even better performance than the much more expensive synthetic grades of magnesium oxide.

Thus, taking into account the state-of-the-art technology and properties of the product, MagPro® has the best price-quality ratio in comparison with the alternative grades of magnesium oxide.

The line has a capacity of 7,500 tons per year. The final commissioning took place in November 2018.

Dr. Andreas Kicherer and Dr. Stefan Gräter talk about the different types of plastic waste and their recycling



Products made with Chemically Recycled Plastics

BASF is breaking new ground in plastic waste recycling with its ChemCycling project

Chemical recycling provides an innovative way to reutilize plastic waste that is currently not recycled, such as mixed or uncleaned plastics. Depending on the region, such waste is usually sent to landfill or burned with energy recovery. But chemical recycling offers another alternative: Using thermochemical processes, these plastics can be utilized to produce syngas or oils. The resulting recycled raw materials can be used as inputs in BASF's production, thereby partially replacing fossil resources.

BASF has for the first time manufactured products based on chemically recycled plastic waste and is thus one of the global pioneers in the industry. "A responsible use

of plastics is crucial to solve the world's waste problem. This applies to companies as well as to institutions and consumers. With chemical recycling we want to make a significant contribution in reducing the amount of plastic waste," said Dr. Martin Bruder Müller, Chairman of the Board of Executive Directors and Chief Technology Officer (CTO) of BASF SE. "With our ChemCycling project, we are using plastic waste as a resource. In this way, we create value for the environment, society and the economy. We have joined forces with partners throughout the value chain to establish a working circular model," said Bruder Müller. BASF is collaborating closely with its customers and partners, which range from waste management companies to technology providers and packaging producers, to build a circular value chain.

From waste to cheese packaging and fridge components

BASF is already developing pilot products, including mozzarella packaging, refrigerator components and insulation panels, with 10 customers from various industries. Manufacturing products that meet high quality and hygiene standards – which are specifically required for food packaging for example – is possible because the ChemCycling products supplied by BASF have exactly the same properties as products made from fossil resources. Stefan Gräter, head of the ChemCycling project at BASF, sees great potential: "This new way of recycling offers opportunities for innovative business models for us and our customers, who already place great value on products and packaging made from recycled materials but who cannot or do not want to make any com-

promises when it comes to quality.” As a next step, BASF plans to make the first products from the ChemCycling project commercially available.

BASF Verbund offers ideal conditions for ChemCycling

At the beginning of the production chain, BASF feeds oil derived from plastic waste by an oiling process into the Production Verbund. BASF gets this feedstock for the pilot products from the partner Recenso GmbH, Germany. As an alternative, syngas made from plastic waste can also be used. The first batch of this oil was fed into the steam cracker at BASF’s site in Ludwigshafen in October. The steam cracker is the starting point for Verbund production. It breaks down or “cracks” this raw material at temperatures of around 850 degrees Celsius. The primary outputs of the process are ethylene and propylene. These basic chemicals are used in the Verbund to make numerous chemical products. Under the mass balance approach, the share of recycled raw material can be mathematically allocated to the final certified product. Each customer can select the allocated percentage of recycled material.

Technological and regulatory challenges

Both the market and society expect industry to come up with constructive solutions to deal with plastic waste. Chemical recycling is an innovative complement to other recycling and waste management processes. “We need a wide range of recovery options for plastic waste, since not every solution is



suitable for each type of waste or possible for each product application. The first choice should always be the solution that performs best in a life cycle assessment,” explained Andreas Kicherer, sustainability expert at BASF.

However, technological and regulatory conditions must be met before the project is market-ready. For one thing, the existing technologies to transform plastic waste into recycled raw materials such as pyrolysis oil or syngas must be further developed and adapted so that consistently high quality is assured. Furthermore, regional regulatory frameworks will considerably influence to what extent this approach can be established in each market. For example, it is essential that chemical recycling and the mass balance approach are recognized as contributing to the fulfillment of product and application-specific recycling targets.

Responsible handling of plastic waste is crucial

Plastics offer many benefits in technical applications, medicine and everyday life and they are often a better alternative to other

materials. The challenge lies in responsibly managing post-consumer plastics. Functioning waste management systems and responsible consumer behavior with regard to plastics are crucial to solving problems such as pollution from plastic litter. To this end, BASF is involved in various projects at the association level and internationally. For example, the company is member of the World Plastics Council and participates in two programs of the Ellen MacArthur Foundation. Furthermore, BASF has implemented Operation Clean Sweep®, an international initiative of the plastics industry to prevent the loss of plastic pellets, flakes and powder in the environment. BASF’s new ChemCycling project is another milestone in the responsible use of resources.

Electric drive technology continues to have potential for energy savings, and not just in deceleration and braking processes, but during acceleration as well. Track cycling and its hand-sling maneuver provides a good example for how it works. With the hand-sling as inspiration, Kabel.Consult.Ing has developed a drive system that produces acceleration in a comparable way

Picture 1: The hand-sling in Madison racing (Source: Roth Photo)



The Benefits of Intelligent Acceleration Technology in Electric Drives

According to a study conducted by an automotive vendor, in year 2030 approximately 50 million e-vehicles – equipped with various types of drive systems – could be on the road. So it's reasonable to expect that e-mobility solutions that most efficiently exploit deceleration and braking processes (KERS, flywheel, range extenders) and thereby extend the vehicle's range will dominate the future of e-mobility. And we see a parallel to machines, robots, and trains that are continuously in braking or deceleration mode and are equipped with a feedback power module or an intermediate circuit coupling. Investigations by researchers at TH Zürich in Switzerland have shown that e-vehicles require a large portion of the energy just to accelerate the net weight (about two-thirds for e-buses). But if we expand our horizons – to track cycling for instance – we see that the acceleration side has potential for improvement as well. To be competitive in international track cycling, having the right equipment and knowing how to use it are critical factors

alongside things like training, nutrition, and mental preparedness. Today, just having power, talent, and endurance are not enough to excel as an athlete. You also need cutting edge equipment, which is often developed at great expense. In fact, new technology continually shapes how sports are performed.

The hand-sling in Madison racing

Madison racing is a style of indoor track cycling with two-man teams. It gets its name from Madison Square Garden where it was practiced for the first time in 1899 and became a nightly sensation. One of the two racers on each team is always in the race, while his partner rides at a more relaxed pace for a few minutes above the racing track. They use a method called the "hand sling" to switch positions. The rider who is currently in the race propels his partner with his arm. Riders who master this technique (Picture 1) can save a great deal of energy. This technique is a reflection of the rules of two-man racing. Of the two riders on

the track, only one of them is in the race at a time. The other rider can fall back to a slower pace (about 25-35 km/h) for one or two laps before being overtaken by his teammate. The sudden acceleration from the hand sling allows the rider to reach the same speed as the field (about 45-55 km/h) and take his partner's place in the race without making a major effort. From a technical perspective, the hand sling requires great skill. Both riders must hold the handlebars with one hand throughout the entire process. The rider approaching from behind keeps his left hand on the handlebars, holding them on the top bar near the stem. The forward rider holds the handlebars with his right hand in the field drop bars and then uses his left arm to pull his partner's outstretched hand. The hand-sling method is very demanding on the competitors because riders approaching from behind must keep a large distance between themselves and the other riders who are performing the switch in order to avoid riding into their hand-sling and causing an accident.

Application to drive technology

Central winders are used to retain endless materials before or after handling,

Picture 2: The Archimedes spiral and e-vehicle with similar load torque characteristics (Source: Kabel.Consult.Ing)

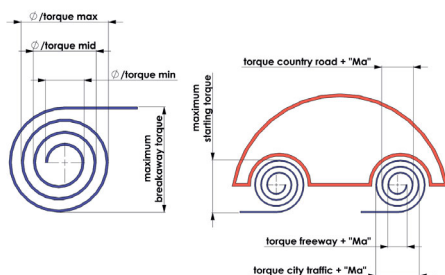

Picture 3: Modular drive with three acceleration modes (»Ma1«, »Ma2«, »IMa1I±IMa2I«) (Source: Kabel.Consult.Ing)



Picture 4: Formula matrix with two power splits and seven acceleration modes (Source: Kabel.Consult.Ing)

$$\sum |P| < ; \sum |T| < ; \sum |n| <$$

	rotor adjustment range / Motor 1 46 ... 100%	rotor adjustment range / Motor 2 46 ... 100%	rotor adjustment range / Motor 3 46 ... 100%
n output	n Motor 1 11	(1 - 11) x n Motor 2 11 x toothed belt 1 x 12	(1 - 11) x (1 - 12) x n Motor 3 11 x 12R1 x 12 x 12R2 x 13
field weakening range / Motor 1 100 ... 133%	field weakening range / Motor 2 100 ... 133%	field weakening range / Motor 3 100 ... 133%	
n output	n Motor 1 11	(1 - 11) x n Motor 2 11 x toothed belt 1 x 12	(1 - 11) x (1 - 12) x n Motor 3 11 x 12R1 x 12 x 12R2 x 13
field weakening range / Motor 1 153 ... 166%	field weakening range / Motor 2 153 ... 166%	field weakening range / Motor 3 153 ... 166%	
n output	n Motor 1 11	(1 - 11) x n Motor 2 11 x toothed belt 1 x 12	(1 - 11) x (1 - 12) x n Motor 3 11 x 12R1 x 12 x 12R2 x 13
field weakening range / Motor 1 166 ... 200%	field weakening range / Motor 2 166 ... 200%	field weakening range / Motor 3 166 ... 200%	
n output	n Motor 1 11	(1 - 11) x n Motor 2 11 x toothed belt 1 x 12	(1 - 11) x (1 - 12) x n Motor 3 11 x 12R1 x 12 x 12R2 x 13

wrapping, or lengthening processes. Mathematically, wound material forms an Archimedes spiral (Picture 2). The material is wound or unwound with a specific tensile force that depends on the material properties, thickness, or diameter. Every wound material places different and sometimes very high demands on the winding drive. So it is very important that the material not be damaged at any time during the winding process. To make things even more difficult, the weight and diameter of the wound material becomes continually larger as the diameter increases. Frictional forces of the bearing and the moment of inertia of the wound mass increase as well.

On central winders, the drive acts on the center of the wound material. The motor torque is transferred through the drive train, drive shaft, and a core to the material web. The web then transfers the torque from the inner layers to the outer layers. The size of the motor is determined by its torque. For central winders, the maximum torque occurs at the largest winding diameter, which coincides with the slowest speed. For this reason, the installed type output (corner power) of central winder drive systems must be significantly greater than the process output. Although high speeds and high torques do not occur simultaneously, the drive must be able to produce both; in this context drive engineers refer to applications with a constant output curve or applications with a linear reciprocally decreasing load torque curve. Electric motors with a high drive output are used in these situations, but their power cannot be fully exploited. The use of converters permits operation of motors in the field weakening range and expands the winding drive's speed range.

Central winders with defined material tractive forces are dimensioned predominantly for stationary operating conditions. In most cases, the dynamic reserves of the converter are adequate to brake the drive, even in emergency situations. However, when torque is very high and braking paths are short, it may be necessary to use braking torque as the relevant variable for dimensioning. On winders with intermittent operating modes, the dynamic drive torque determines proper dimensions. When winding/unwinding

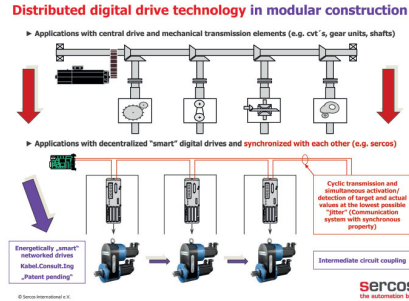

Picture 5: The Madison method (two-man teams) – the future of drive engineering? (Source: Sercos e.V.)

thicker material sheets, bending moment must also be considered for deformation.

The hand-sling principle – the future of drive engineering?

Picture 3 shows the mechanical drive train of a patent-applied drive system from Kabel.Consult.Ing, which includes a planetary gearbox whose sun gear and annulus gear are each driven by identical rotary-current servo motors. The output sides of the drives pass through the bearings of the planetary gears. The mechanical portion of the drive system is characterized by the planetary gearbox's annulus gear, which is driven by a high-performance toothed belt with Kevlar/carbon fiber drawing elements. The toothed belt attaches firmly to the outside of the annulus gear and provides for a zero-clearance draw/slack connection. Using the same principle, the entire system may be coupled modularly to additional drive units of the same type. Picture 4 shows a formula matrix with two power splits and three drive motors with variables for rotor adjustment range, field weakening range, torque, speed, and output.

The drive speed of the modularly coupled drive system is calculated according to the expanded Willis formula. According to the formula, motors are operated in the field weakening range when requirements are low. As torque requirements increase within the "classic rotor adjustment range", the motors operate preferably as single drives. If even higher output or a higher torque is required, this is achieved by connecting additional motors (using a principle exemplified by the hand-sling) that had been blocked. Picture 5 shows a block diagram of a complete drive system for a constant-speed application.

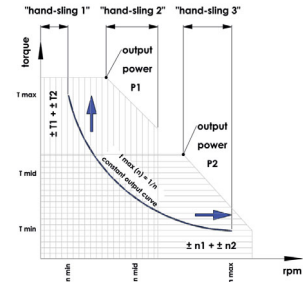

Picture 6: Telescoping L-output with two drives and three "hand-slings" (Source: Kabel.Consult.Ing)

Each of the drive trains shown on the diagram has two drive motors. Depending on the purpose of the application, the individual driveshafts may be subject to various speeds/torques or performance curves. In contrast to a conventional "one-motor" design, this new drive concept consists of at least two servo amplifiers (double module) and rotary current servo motors plus a planetary gearbox comprised of high-performance toothed belts. It has the advantage of significantly higher overall efficiency and allows installation of smaller-output motors with lower operating costs. The complete drive system has the general benefits associated with modularity:

- For designers: lower development costs, economical production with unit-price degression, several series of identical design, and consistent and straightforward assembly processes.
- For users: exchangeable modules make repairs fast and economical. Compatibility and use of shared parts reduce the need to hold spare parts to a minimum. Consistent modularity greatly expands the benefits for both the manufacturer (sales, assembly, spare parts service) and users (purchasing, operation, repairs). The new drive system is SIGNO-funded and is also part of a funding initiative by Germany's Ministry of Economic Affairs and Energy.

Author: Juan Carlos González Villar, development engineer and process optimizer at Kabel.Consult.Ing in Mönchengladbach (Germany)

Kabel.Consult.Ing
 Reststrauch 55 , 41199
 Mönchengladbach, Germany
 www.kabelconsulting.de

The new highly automated modular Kiefel vacuum lamination system utilizing the TBL process (Tailored-Blank-Laminating)



New Tailored Blank Laminating Technology (TBL) – intelligently automated

Cost pressure in the automotive industry is a constant. The OEM's are expecting interior products like door-uppers, armrests or even entire door panels and instrument panels to have excellent quality at a very economic price. Vacuum laminating is the key to this success utilizing high automation to insure the best product quality at the lowest price level. Kiefel's answer to this high customer demand is the newly designed and developed "Tailored Blank Laminating" Technology and Machine

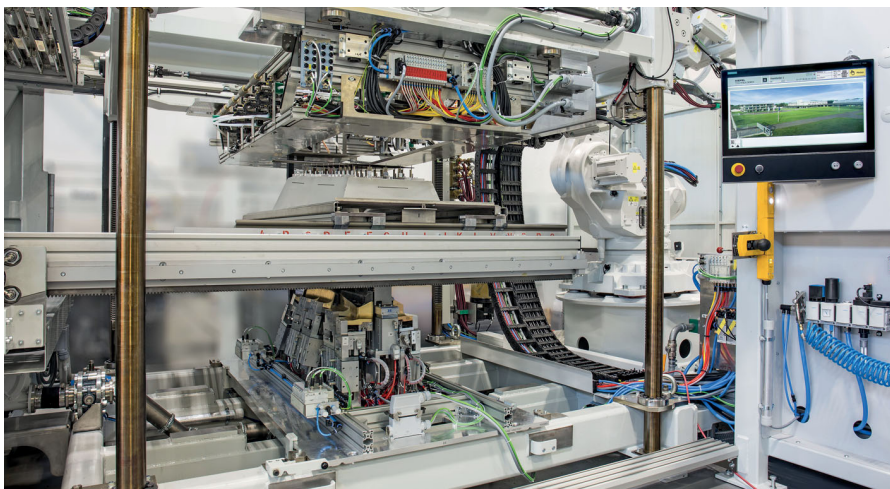

Laminating station of the TBL vacuum lamination system

The innovated Kiefel TBL vacuum laminating machine operates completely automatic, without any operators. Operators are substituted by robots. The unique feature: Tailored blanked exact foil precuts will be used. Thus how the name of this new technology was derived.

By utilizing a uniquely designed servo motor gripper system, the Tailored blank foil precut will be positioned and aligned on the substrate without any foil pre-stretch before the TBL-tool will be closed and the vacuum laminating process takes place. Cutting knives, integrated in the TBL-tool are responsible for exact foil overlap length for the subsequent edge-folding process.

For this application Kiefel developed a completely new highly automated vacuum laminating machine. Robots which are integrated components of the machine are not responsible for movement of tool components and parts only. These robots will also be used to transfer the TBL-laminated parts to the subsequent process, e.g. edge-folding or punching. It means that the automation solution is integrated in the machine and more or less free of charge.

The TBL machines new innovative design reduces the overall machine footprint by 50% in comparison with traditional vacuum-laminating machines with the same

Tailored-Blank precision cut blank in the new Tailored-Blank-3D servo gripper frame

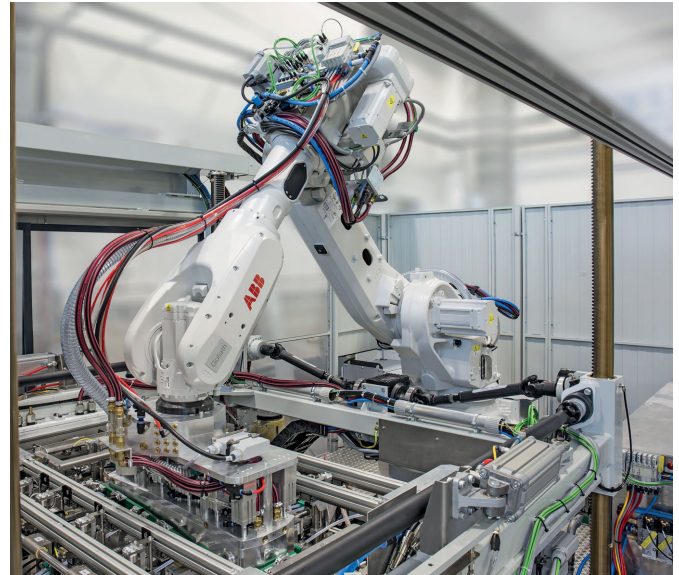
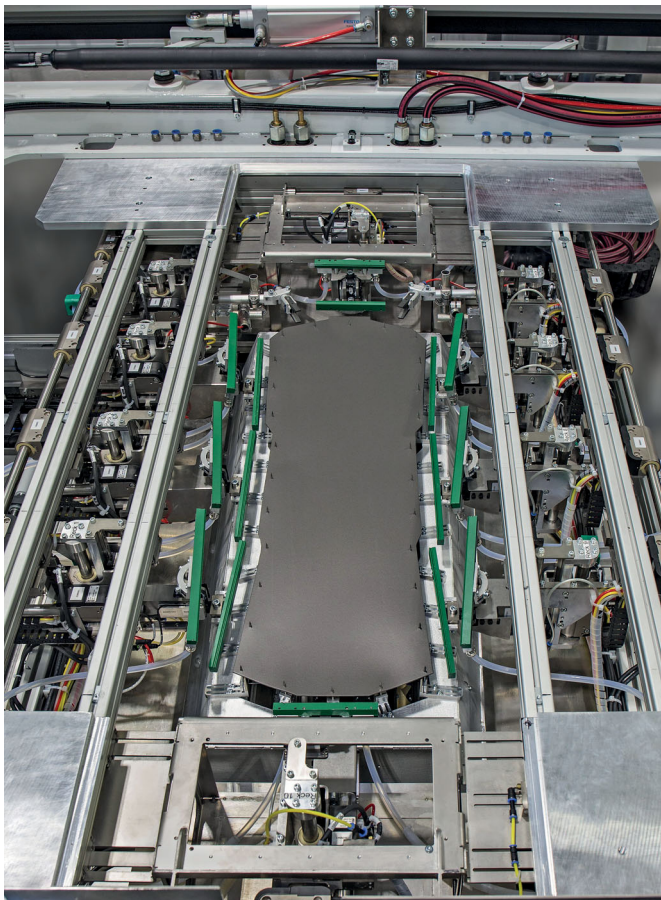

Forming station with robots for lamination process and parts handling of the vacuum lamination system

output, which is another big advantage of this new TBL-machine.

Based on using the tailored blanks foil exact-precuts the entire foil consumption can be reduced up to 40% in comparison to traditional vacuum-laminating technology. The TBL technology interior parts will be produced at a more cost effective rate offering savings over the production period of 5 years in the range of millions of Euro.

Simultaneously, the foil stretch and the grain wash-out, the main quality factor of interior parts, will be significantly reduced to a range of 10 to 15 %. The remaining constant foil thickness and the overall soft-touch of TBL parts offer another quality advantage of the parts produced by TBL-Technology. This allows repeatable and pre-determined gap conditions to neighboring parts. Sharp corners and sharp flanges are also possible based to the exact alignment of the foil before vacuum lamination process.

Main Benefits at a glance:

- Improvement of product quality
- Reduced foil consumption
- Reduced machine footprint
- Full flexibility
- High level of automation
- Integrated robot automation
- Smart and better alternative to In-Mold-Graining

Liner Films for Flexible Intermediate Bulk Containers



Not only do Mondi's FIBC liners advance customers' processes and logistics, but their superior quality reduces the amount of raw materials used and offers an environmentally friendly alternative to aluminium barriers

Mondi is investing in its Styria, Austria, plant to further boost its ability to offer safe, clean, environmentally friendly liners for Flexible Intermediate Bulk Containers

“Mondi’s FIBC liners ensure clean food processing and are ideal for milk powder, other foods, pharmaceuticals and additional applications,” notes Stefan Pfundner, Business Solution Manager, Mondi Technical Films. “Not only do Mondi’s FIBC liners advance customers’ processes and logistics,” he explains, “but their superior quality reduces the amount of raw materials used and offers an environmentally friendly alternative to traditional liners.”

The Mondi Styria film extruding plant already is well known for its outstanding hygiene standards and innovative sustainable product development. The site has extensive experience in developing more environmentally friendly products, including thinner, downgauged films and ply constructions ready for recycling. Now, with its latest innovation, Styria is enabling the elimination of aluminium inner layers in FIBC liner films.

Mondi is installing new equipment at Styria to make high-barrier, side-gusseted tubes for FIBCs.

This latest equipment upgrade will make Mondi Styria the only plant of its kind able to produce these types of tubes in such food-clean conditions. That facility has earned three straight “AA” certifications per the British Retail Consortium (BRC) global

standard for packaging and packaging materials. That certification gives qualifying brands an internationally recognised mark of quality, safety and responsibility.

The new side-gusseting device will enable Mondi to provide converters with tubes up 4,400 mm in total circumference. It will come equipped with a special HEPA air filter to clean the air within the blown-film bubble to remove bacteria and particulates, yielding nearly sterile conditions, Pfundner said.

Mondi makes the high-barrier tubes and supplies them to customers who then produce the actual FIBC bags. By adding permanent antistatic additives to both the inside and outside of the film, Mondi can greatly reduce the dust-explosion hazards in combination with a Typ B Big Bag associated with filling or discharging of bulk powders.

“Ensuring appropriate levels of hygiene during production and packaging is vital for suppliers of foods and other products,” Pfundner said.

“Due to our well-established relationships with some of the leading multinational brands, as well as with the leading producers of such demanding products, we decided to extend our bulk-packaging portfolio by adding production in Styria of high-barrier, side-gusseted tubes.”

Liners produced from high-barrier, side-gusseted tubes minimise the risk of contamination on the inside, compared with liners produced from flat film or foil, such as aluminium liners, he said. Mondi also can adapt the barrier properties according to the needs of the product, to protect against odours, moisture and the like. With such tubes offering a viable alternative to aluminium liners and other kinds of laminate structures, FIBC packagers potentially can not only save money, but also reduce their carbon footprint.

Mondi additionally can tailor-make multilayer films using a variety of structures, from PE to PE/PA and PE/EVOH to seven layer PE/PA/EVOH structures, additives and colours to provide solutions for all kinds of industries, from food to chemicals, minerals or pharma.

The outstanding properties of Mondi’s FIBC liner films make them ideal for food, pharmaceutical and other critical applications, while also helping to advance bag manufacturers’ processes and logistics. These films boast stringent certifications that document their excellent performance related to oxygen and moisture barriers, anti-static properties and overall mechanical strength.

“We see this as an excellent time to boost our presence in the growing milk powder market and related bulk-packaging sectors by leveraging our expertise in customisable barrier-film technology in conjunction with Mondi Styria’s superb hygiene-related packaging,” said Pfundner. “When it comes to our vast portfolio of technical films, Mondi continues to be all about advancement, with the aim of reducing cost and complexity, and enhancing properties and functionality for our customers worldwide.”



SBI is a popular producer of inline thickness measuring devices for film and sheet extrusion. The new developed gauge (KAPA-IR) contains the capacitive measurement process and in addition to it also a special infrared (IR) which is a sensor system that determines the EVOH (Ethylene vinyl alcohol) layer thickness

KAPA-IR thickness measuring device for detecting the EVOH barrier layer



New Barrier Layer (EVOH) Inline Thickness Measuring Device introduced

This additional measurement system makes it possible to detect the EVOH layer of transparent and opaque multi-layer plastics. To determine the EVOH layer thickness, a wide infrared

spectrum of the plastic is recorded and the resulting absorption of the EVOH polymer molecules is evaluated by using our modern analytical methods.

SBI mainly focuses with this measuring system on measuring PP/EVOH/PP sheets, but it is also possible to gauge other EVOH-polymer compounds with the help of extended analysis-algorithms.

The new gauge measures the total thickness of multi-layer sheets in microns (see diagram 1), the die bolts over the measuring width (see diagram 2), and in addition to it the EVOH layer distribution which is shown in diagram 3.

The infrared measuring system is a relative measurement and yields the absolute EVOH layer thickness by the means of calibration.

Nowadays it is essential to determine the EVOH layer distribution to deliver a consistent quality. In most case of applications, the EVOH thickness is determined in laboratories by microscopes.

SBI delivers an in-line, non-contact and user-friendly thickness measurement to control the EVOH barrier layer during the production process.

Display for total thickness, bolt and EVOH thickness



SBI Produktion techn.
Anlagen GmbH & Co KG
Kaplanstr. 12, 2020 Hollabrunn, Austria
www.sbi.at



PLASTIMAGEN



MEXICO 2019 APRIL 2 - 5

Centro Citibanamex / Mexico City

EXHIBITION FLOOR
REGISTRATION IS FREE
FOR INDUSTRY
PROFESSIONALS

Sponsor Registration

Wittmann Battenfeld

INNOVATION NEVER STOPS!

The implementation of Industry 4.0 is revolutionizing the plastics sector with innovative applications to generate business that ranges from production control and efficiency to strategic planning, with the main objective of optimizing processes through the use of data technologies, systems, and devices.

DATA COLLECTION AND CONTROL OF STATISTICAL PROCESSES IN REAL TIME

PLASTIMAGEN MÉXICO® a first class exhibition, offers a highly attractive alternative for all visitors.

Find solutions developed using the latest technology that drive the growth of ever increasing number of industries.

The exhibition floor covers more than **45,000 m2**, showcasing over **870 exhibitors** representing more than **1600 brands**, **14 international pavilions**, and the **ANIPAC Pavilion** (National Association of Plastic Industries in Mexico).



MEET WITH MANUFACTURERS AND SUPPLIERS
presenting solutions in: Machinery / Equipment, Raw Materials, Transformers, and Various Products/Services for the Plastic Industry.



and many others...

Connect with the world's top companies at Mexico and Latin America's most important and comprehensive plastics expo

www.plastimagen.com.mx

PLASTIMAGEN | Plastimagen | @plastimagen | plastimagenmx

Gold Sponsor

Braskem Idesa

Silver Sponsors



Organized by:



Certified by:



Member of:



Supported by:



Venue:



MORE INFORMATION TO EXHIBIT:
Ed Park
International Sales Manager
E.J. Krause & Associates, Inc.
Direct: 301-844-6864
ed.park@ekrause.com



IPTF 2019

7th INTERNATIONAL POLYMER TECHNOLOGY FORUM

June, 4-5, 2019
AZIMUT Hotel
St. Petersburg,
Russia

PRACTICAL SOLUTIONS FOR PLASTICS PROCESSING



More than **60** plastics processing companies

More than **180** participants



KEY ISSUES

- Reduction of unplanned downtime and repairs - online diagnostics, monitoring and service.
- Digital transformation of a polymer industry enterprise - how to start?
- Modernization of equipment: from idea to implementation. How to avoid mistakes?
- What are the reserves for optimization at each stage of production (transportation, dosing, mixing, heating or cooling, extrusion or injection moulding, quality control, etc.)?
- "Lean" in the processing of plastics

SEPARATE PARALLEL SESSIONS for polymer processors by the methods of EXTRUSION and CASTING – producers of films, pipes, PVC profiles, plastic containers and other polymer products – for each group of manufacturers - the subtleties of technologies and processes, raw materials and additives, equipment and individual components, discussions, experience and exchange of views. We know that you are interested.

Organizers

F PR.EVENTS

EXTRUSION



Contacts

IPTF.RU

in Germany +49 2233 949 8793
a.kravets@vm-verlag.com

in Ukraine +38 098 1226234
info@fprevents.com

in Russia +7 499 346 68 47, info@iptf.ru
+7 917 011 45 47
russia@vm-verlag.com
+7 846 276 40 45
reklama@plastics.ru