

01/2021

VVA VERLAG  
Cologne /Germany



# EXTRUSION INTERNATIONAL

USA

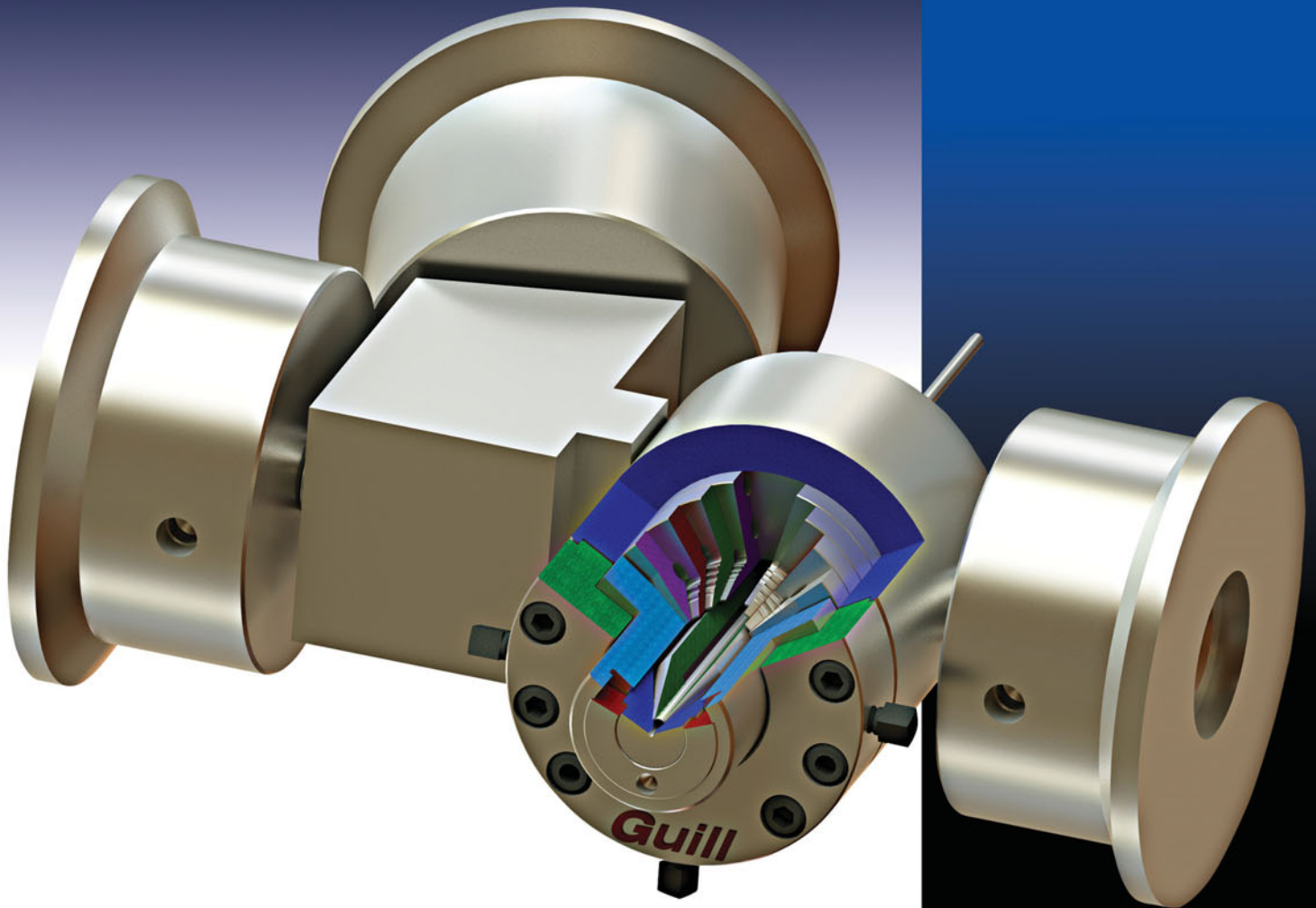

**Guill**  
EXTRUSION TOOLING

3-layer Medical Tube Die

## Profile guillotine PTT-200

INNOVATION



- Especially for complex as well massive profiles.
- Basic construction consists a frame in solid Aluminum construction in which the controls are integrated.
- Through large sliding windows fast and comfortable access to the cutting unit.

### Particularities:

- For this special version of the cutting knife head the cutting knife can be set in any position. This allows the slope of the knife to the respective profile geometry optimally adapted become.
- A new clamping system, which fix the knife at 4 points. It allows more pulling force on the blade to cut more massive profiles.
- The new clamping system result in a much higher angular accuracy of the cut.

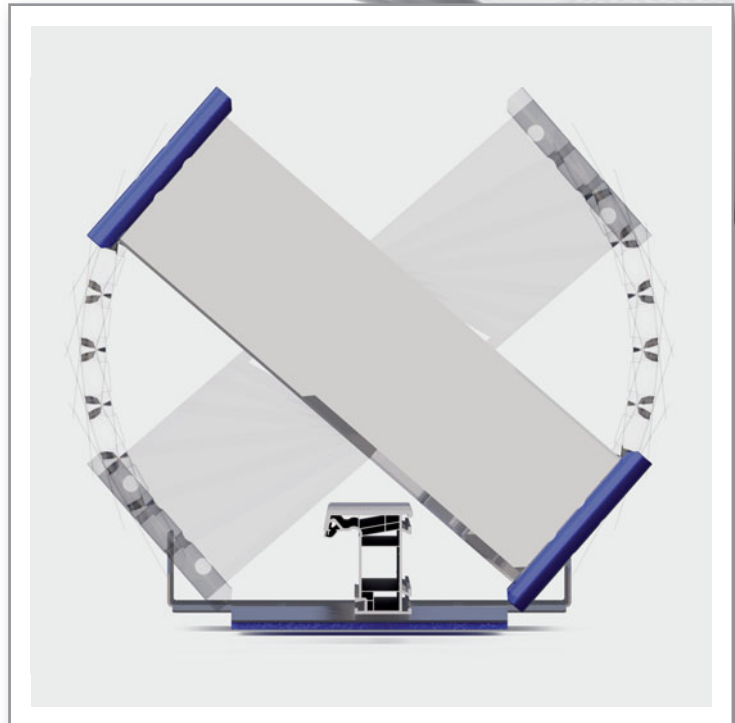

Made in  
Germany

## PCL Profile separating machine



When profiles are extruded, start-up profiles occur again and again. They are representing a high material value. It is very labour intensive to recycle this profiles.

With the PCL profile separating machine from Stein Maschinenbau, this process is greatly facilitated and accelerated many times over.

Thanks to its quickly exchangeable cutting units, as well as the two powerful caterpillars, the PCL can cope with any profile and allows you to recycle your profiles in the best possible way. By non-cutting separators, the profile is split into individual Material fractions which are optimally recyclable. Smaller sections are sorted and granulated directly in the machine.

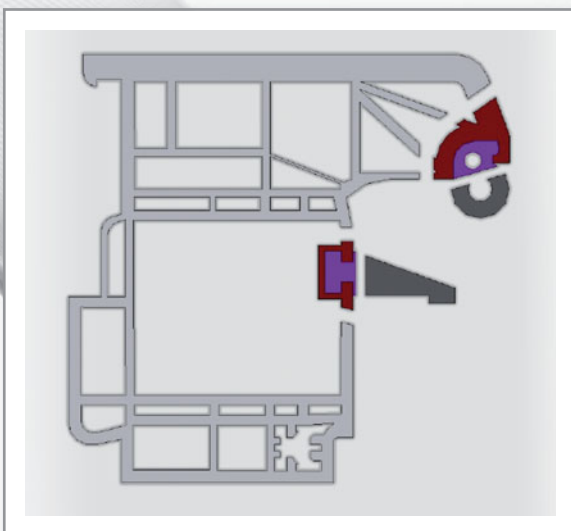

### Your advantages

- + High throughput
- + Short changeover times
- + Highest possible Recycling degree
- + Unmixed material separation



**STEIN Maschinenbau  
GmbH & Co.KG**

Wartbachstr. 9  
D-66999 Hinterweidenthal/Germany  
Tel. +49/63 96/92 15-0  
Fax +49/63 96/92 15-25  
stein@stein-maschinenbau.de  
www.stein-maschinenbau.de

**The PCL from Stein Maschinenbau  
separates YOUR profiles!**

Firms in this issue	6	Compostable Paper Laminate for Flexible Packaging	24
Imprint	7		
<b>Industry News</b>	8	<b>Industry News USA</b>	26
Calendar	8	Extrusion Coating Line Installed	26
The Date for interpack 2023 is Set	8	50 Years of Global Leadership in Polymer Extrusion and Fluid Coating Dies Celebrated	27
ICE Europe 2021 Postponed	8		
PLAST Postponed	9	Expands Global Gate Portfolio for Plastics and Rubber	27
Wire and Tube – Terms for 2022 are set	9	Acquisition	28
NPE2021 Cancelled	9	Collaboration on First Paving Project Using Recycled Plastic	28
CHINAPLAS 2021 – Igniting New Momentum during Challenging Times	10	Weatherable Capstocks for WPC Decking	29
New Shrink Film Line for an Enhanced Product Portfolio	11	Newly Installed Lines Address Swab Stick Demand	30
Fakuma 2021 – The Course is Set for Circular Economy	12	Expansion of Color Concentrate Capabilities in Vietnam	30
Difficult Year for Italian Manufacturers of Plastics and Rubber Processing Machinery	12	Market Development Manager for Pelletizing Systems Appointed	31
System Components and Controls for Plastics Production	14	Vice President Appointed	31
Acquisition	14	<b>Extrusion Tooling</b>	
High International Rating Received	15	Reciprocating Head introduced – Automated Extrusion Process Drastically changes the Extruded Profile	32
Seamless Commissioning of Systems Thanks to Optimal Preparation on the Digital Twin	16		
New Managing Director	16	<b>Film Extrusion</b>	
Changes in the Board of Executive Directors	17	Silage Film for Bale Wrap	34
Construction of an Extrusion System in Italy – Bottle Cycle Expediting	17	<b>Film Coating</b>	
Investment into Expansion of Production	18	BOPP and BOPE Inline Coating – Perfect Barrier, Improved Recyclability	35
New Sales Area Manager	18	<b>Extrusion Technology</b>	
New Exclusive Distributor for PVC Additives in India	19	Next Generation Lines of Twin-screw Extruders Introduced in the U.S. and Canada	36
Even Closer to Customers	19	<b>Recycling</b>	
The Trend is Towards Big Plants and the Highest Quality Recyclate	20	Investment in Austrian Recycling Technology	38
PLA Compounds – Contribution to the EU Green Deal 2030	20	<b>Quality Control</b>	
Maximising Production Capacity with a Minimal Investment	21	External Inspection Solution for Highest Polymer Quality	40
PP Additive for Thermoforming	22	<b>Circular Economy</b>	
„Closed The Loop“ Pilot Project Eliminates Single-Use Cups	22	Oil from Plastic Waste	41
State-of-the-Art Plant for Post-Consumer Plastic Waste Sorting and Advanced Mechanical Recycling Opened	23	<b>Recycling</b>	
ColorForwardTM	23	Reliable, Trouble-Free Melt Filtration as a Decisive Factor for the Economical Use of Reclaim in Plastics Processing	42
Extrusion Tooling – New Crosshead	24	<b>Recycling</b>	
Divestiture of Screws and Barrels Product Line	24	First Fully Recyclable Packaging Tube	44
		<b>Recycling</b>	
		Raffia Producer Now Recycles in One Step	46



**34** Newly developed formulations from SML make it possible to manufacture high-quality silage film on its cast stretch film lines. Compared with the manufacturing of blown silage film, this new approach offers some key advantages

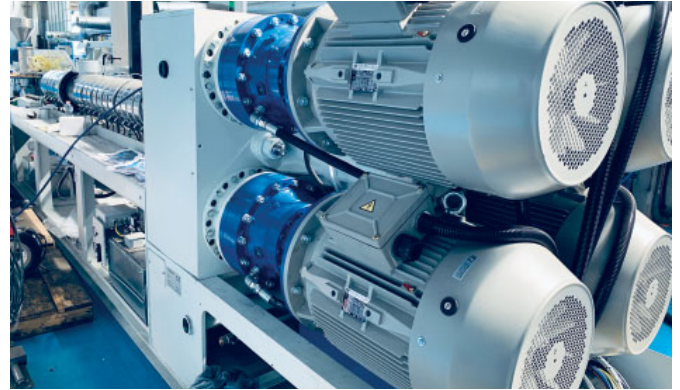

**36** Bausano announced the introduction of its next generation lines of twin-screw plastic extruders in the U.S. and Canadian markets. The two renewed product lines are best suited for several types of extrusion, pipes, granules, wood plastic composites (WPC), profiles and materials used in the medical industry



**38** The Pan Era Group is progressing on one of its most ambitious growth steps so far, which is the establishment of yet another plastic recycling plant in Cikande, Indonesian. It is at this new location that Pan Era Group relies on Austrian recycling competence and has ordered an ES-compound extrusion line with an output of 1000 kg PE per hour from MAS



**42** If inhouse waste and heavily contaminated post-consumer waste are added to the production process, foreign particles are introduced into the melt flow. These have to be filtered out efficiently. Several filtration systems require a production interruption when changing screens. With the Gneuss Rotary Technology, the conditions in the melt flow are permanently constant

Post-industrial recycling of PP raffia, woven sacks, tapes, non-woven/woven could be challenging at times for some producers. It's difficult to process in one single step due to size and strength of the material waste. Polystar's Repro-One recycling machine provides solutions to many problems

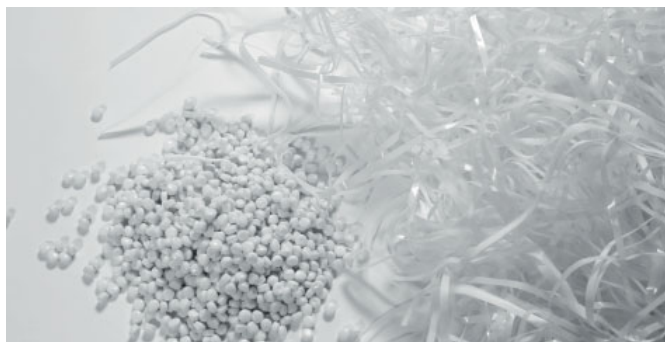

The inline coating technology offers decisive advantages for BOPP and BOPE applications. Brückner's newly developed technology is installed between the machine film orientation (MDO) and the transverse film orientation (TDO) process



**36**

**38**

**42**

**46**

**35**

## Index of Advertisers, companies and *fairs* referred in this issue

AdEx Home 2021 .....	25	Kautex .....	16
Adsale .....	10, Outside Back Cover	KraussMaffei .....	16
ALPLA .....	17	<b>Liansu</b> .....	19
Altair .....	24	Maag .....	14
AMAPLAST .....	12	Mack-Brooks .....	8
Association of Plastic Recyclers .....	44	Maguire .....	28
Atlas .....	14	Makwell Plastisizers .....	19
Avient .....	23, 30	MAS .....	33, 38
BASF .....	17, 24	Messe Düsseldorf .....	8, 9, 27
battenfeld-cincinnati .....	41	Milliken .....	22
Bausano .....	21, 36	<b>motan-colortronic</b> .....	7
BillerudKorsnas .....	24	Nordson Corporation .....	24, 31
BIO-FED .....	20	Nordson Polymer Processing .....	27, 31
Blue Alp .....	41	<i>NPE2021-02-05</i> .....	9
Borealis .....	22, 23	O.A. Newton .....	28
Brückner .....	11, 35	OCS .....	40
<b>CHINAPLAS</b> .....	10, Outside Back Cover	<i>PLAST 2021</i> .....	9
COLINES .....	18	PLASTICS .....	9, 28
Davis-Standard .....	26, 30	POLYPLASTIC .....	15, 18
EPL .....	44	POLYSTAR .....	44
EREMA .....	13, 20	<b>POWERFIL</b> .....	13
Fakuma .....	12	Promaplast .....	9
Gneuss .....	42	Schall, P.E. ....	12
Guill .....	Outside Cover, 24, 32	<b>Smart-Extrusion</b> .....	11, 45, Inside Back Cover
<i>ICE Europe</i> .....	8	SML .....	17, 34
ILLIG .....	19	Songwon .....	19
<i>interpack</i> .....	8	<b>Stein Maschinenbau</b> .....	Inside Front Cover+3
<i>IPTF</i> .....	43	Teknor Apex .....	29
Jagenberg .....	14	TOMRA .....	23
Kampf .....	14	Zumbach .....	15

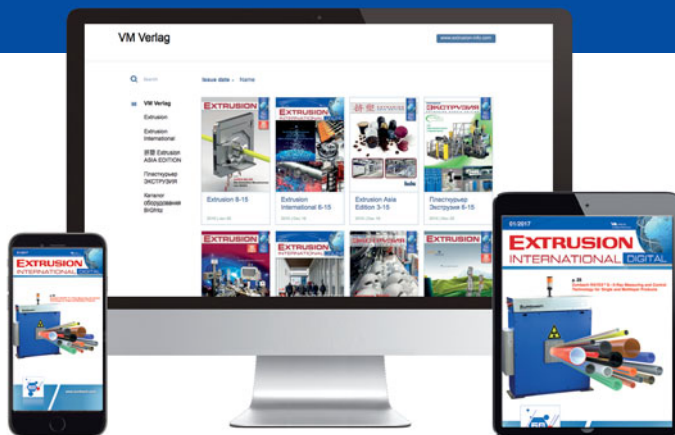

**Follow the news  
in the world  
of extrusion!**

Subscribe to digital magazines  
and Smart Extrusion weekly newsletter

- **Just** submit your **e-mail address**.
- Digital magazines and news updates **free of charge**
- No spam. Your data is safe



[www.extrusion-info.com/subscription](http://www.extrusion-info.com/subscription)



The Extrusion International Magazine is published bimonthly by VM Verlag GmbH. P.O.Box 501812, D- 50879 Cologne, Germany

**EDITORS**

Bettina Jopp-Witt (Editor-in-chief)  
Tel. +49 221 546 1539  
redaktion@vm-verlag.com

Dmitry Kosuch  
Tel. +7 996 730 0113  
d.kosuch@vm-verlag.com

**ADVERTISING SALES**

Martina Lerner  
Tel.+49 6226 971515  
lerner-media@t-online.de

Bella Eidlin  
Tel. +49 152 29907895  
b.eidlin@vm-verlag.com

Olga Kirchner  
Tel. +49 152 05626122  
o.kirchner@vm-verlag.com

**ADMINISTRATION**

Alla Kravets  
Tel. +49 2233 949 8793  
a.kravets@vm-verlag.com

**PRINTING**

maincontor GmbH  
Dr.-Gammert-Str. 13a, 63906 Erlenbach, Germany  
T.: +49 937294810811  
www.maincontor.de, info@frankhohmann.com

**SALES REPRESENTATIVES**

Quaini Pubblicita (Milano IT)  
Tel. +39 02 39216180  
info@quaini-pubblicita.it

China & Asia  
octavia@ringier.com.hk, Tel. +852-9648-2561  
maggieliu@ringiertrade.com, Tel. +86-13602785446

Tokyo PR Inc. (Japan)  
Tel. +81 (3) 3273-2731  
extrusion@tokyopr.co.jp

**Reprints, Translation etc**

No part of this publication may be reproduced, stored in a retrieval system, or transmitted, in any form or by any means, electronic, mechanical, photographic, recording or otherwise, without prior permission of the publisher.



[www.smart-extrusion.com](http://www.smart-extrusion.com)

**motan®**   
**colortronic®**

**ATTN dries gently at a constant dew point**

 think materials management

**LUXOR A**

ATTN brings more security in your drying processes. That protects your material, ensures quality and saves you energy.

motan-colortronic gmbh - [info@motan-colortronic.de](mailto:info@motan-colortronic.de)  
[www.motan-colortronic.com](http://www.motan-colortronic.com)



#### CHINAPLAS

13. - 16. 04. 2021  
Shenzhen / P.R. China  
[www.ChinaplasOnline.com](http://www.ChinaplasOnline.com)

#### Plastics Extrusion World Expo Europe

01. - 02. 06. 2021  
Essen, Germany  
<https://eu.extrusion-expo.com/>

#### wire Russia, Tube Russia

08. - 10. 06. 2021  
Moscow, Russia  
[www.wire-russia.com](http://www.wire-russia.com), [www.Tube-russia.com](http://www.Tube-russia.com)

#### rosplast

15. - 17. 06. 2021  
Moscow, Russia  
[rosmould.ru.messefrankfurt.com/](http://rosmould.ru.messefrankfurt.com/)

#### Solids Dortmund

16. - 17. 06. 2021  
Dortmund / Germany  
[www.solids-dortmund.de](http://www.solids-dortmund.de)

#### Plastics & Rubber Vietnam

16. - 18. 06. 2021  
Ho Chi Minh City, Vietnam  
[www.k-globalgate.com/prv](http://www.k-globalgate.com/prv)

#### COLOMBIAPLAST

22. - 25. 06. 2021  
Bogotá, Colombia  
[www.colombiaplast.org](http://www.colombiaplast.org)

#### SCHWEISSEN & SCHNEIDEN

13. - 17. 09. 2021  
Essen, Germany  
[www.schweissen-schneiden.com](http://www.schweissen-schneiden.com)

#### Equiplast

14. - 18. 09. 2021  
Barcelona, Spain  
[www.equiplast.com/en](http://www.equiplast.com/en)

## The Date for interpack 2023 is Set

■ The next interpack will take place from 4 to 10 May 2023 at the Düsseldorf Trade Fair Centre. Messe Düsseldorf set this date in agreement with its partners and committees. Interested companies from the packaging sector and the associated processing industry will be able to register online at from the end of March/beginning of April provided all goes to plan. Exhibitors who were approved for interpack 2021, which was cancelled due to the pandemic, have already been able to reserve their stand positions for 2023 and will now be able to rebook when they register.

► Messe Düsseldorf GmbH  
[www.interpack.com](http://www.interpack.com)

## ICE Europe 2021 Postponed



■ Mack-Brooks Exhibitions has announced the postponement of ICE Europe, CCE International and InPrint Munich 2021, which were scheduled to take place at the Munich Trade Fair Centre in Germany from 9 to 11 March 2021. Instead, the collective of converting, paper and print exhibitions will run from 22 to 24 June 2021. This decision was taken in light of the ongoing Covid-19 pandemic and continued uncertainties regarding travel restrictions and event planning by the authorities. Commenting on the announcement, Patrick Herman, Event Director of the Converting, Paper and Print Events at Mack-Brooks Exhibitions said: "Following careful consideration of various options we have come to the decision to hold the shows in June 2021. (...) The combination of three dedicated trade events evolving around converting and printing in the manufacturing process creates a multifaceted experience with increased opportunities and synergies. However, our main focus is to ensure a successful participation for our visitors and exhibitors. And in order to do that we need to get the conditions right."

(Picture: Mack Brooks Exhibitions)



► Mack-Brooks Exhibitions Ltd  
[www.ice-x.com/europe](http://www.ice-x.com/europe)



## PLAST Postponed



■ In light of the ongoing pandemic and uncertainties regarding the timeline and methods of the vaccination campaign – elements that continue to condition activities in the plastics and rubber industry and, most importantly, strongly limit travel by Italian and foreign operators – and as urged

by exhibitors, the organizers of PLAST has decided to postpone the event to a future date to be determined, but certainly after the end of 2021.

The difficult decision to postpone has been taken regretfully but responsibly, the prime objective being to ensure the safety of all parties involved. The organizers look forward to being able to schedule the next PLAST under the best conditions possible and with in-person attendance.

The previous edition of the trade fair took place in Milan from 29 May to 1 June 2018. It featured 1,510 exhibitors from 55 countries, occupied a net area of 55,000 m<sup>2</sup> in six halls of Fiera Milano in Rho-Pero, and drew in 63,000 visitors from 117 countries.

► PROMAPLAST srl  
www.plastonline.org

## wire and Tube – Terms for 2022 are Set

■ After the cancellation of the leading international trade fairs wire and Tube 2020 due to the current COVID-19 infection situation, the next editions will take place from May 9 to 13, 2022.

“We look forward to welcoming exhibitors and visitors to Düsseldorf in person again,” says Daniel Ryfisch, Project Director wire / Tube & Flow Technologies. “Corona has shown that digitalization brings many advantages. But it cannot replace personal meetings, conversations and contacts”.

wire and Tube, which were originally planned for March 30 to April 3, 2020, were on a record course until the COVID-19 related postponement. The number of registrations from exhibitors and visitors in spring exceeded all expectations.

“For us this was a further signal and renewed confirmation that we have the No. 1 trade fairs for the wire, cable and tube industry here in Düsseldorf”, explains Daniel Ryfisch. “This is where the international top decision-makers of the exhibitor and visitor sectors come together.”

Companies wishing to exhibit at wire and Tube 2022 can already register starting at the end of March 2021. The official registration deadline is summer 2021, and the exact dates will be announced by Messe Düsseldorf at a later date.

► Messe Düsseldorf GmbH  
wire.com, Tube.com

## NPE2021 Cancelled

■ The Plastics Industry Association (PLASTICS) places the health and safety of their members, exhibitors, staff, and the attendees as its highest priority. After consultation with medical and legal experts, the Officers of the Board, the NPE executive committee, exhibitors, and the association membership, the PLASTICS Board of Directors decided to cancel the NPE2021 planned for May 17-21, 2021 due to the ongoing coronavirus pandemic.

While disappointed by the circumstances that led to this decision, they know that the plastics industry is strong and

resilient. Over the past ten months, it has been leading the transformation of manufacturing processes and supply chain operations that deliver medical equipment and supplies to pharmaceutical companies, medical supply manufacturers, and healthcare workers, protecting first responders and frontline workers against the coronavirus. By bringing companies at the forefront of plastics manufacturing together in other ways, the organizer PLASTICS will continue to provide opportunities for the industry to unite to solve today’s needs and reimagine how to meet tomorrow’s challenges.

► The Plastics Industry Association (PLASTICS)  
plasticsindustry.org, npe.org

## CHINAPLAS 2021 – Igniting New Momentum during Challenging Times

13 to 16 April 2021, Shenzhen, P.R. China

■ In today's unprecedented turbulent times, the global manufacturing industry is undergoing profound and complex changes, facing uncertainties and challenges, while opening up new opportunities under the new normal. CHINAPLAS 2021 themed "New Era • New Potential • Innovation for Sustainability", will not only stimulate development in the industries, but also keep the momentum going in the exploration of business opportunities in the new era.

In a special period when COVID-19 has brought a lot of uncertainties to the global economy, China has been taking actions to contribute more certainties to the world. China's economy recovered strongly following the COVID-19 pandemic. After a sharp V-shaped rebound in the first six months of the year, China's GDP expanded 4.9% in the third quarter. It is predicted that China will be the only major economy in the world achieving positive growth in 2020. When the economy is rapidly recovering, China is leading consumption upgrade, enhancing self-innovation capacity to push forward the high level opening up to the world, and hastening the establishment of a new development model featuring dual circulation in the domestic and international markets where the former plays a leading role.

An unimpeded domestic circulation is the key. The main focuses are reconstruction of the industrial foundation and upgrade of the production chain. China has a fully equipped industrial system and a complete industrial chain, providing huge room for technological innovation and application.

In the post-pandemic era, demands for healthcare, smart-tech, eco-friendliness, convenience and comfort have increased sharply. The sales and exports of household products like kitchen appliances and fitness equipment have

*A lot of green and recycling solutions will be found at CHINAPLAS*



*Demands on fresh food distribution and household electronic appliances are igniting new momentum in the market*

risen. Demands on fresh food distribution, express delivery and convenience food products have increased in adverse market conditions. A surge in diversified, personalized and high-quality demands will give rise to more new consumption patterns and forms of business.

Technological innovation is the key for China's domestic demand expansion, new infrastructure, domestic substitution and realization of plastics recycling. It is necessary for enterprises to speed up technology innovation, business upgrade and transformation to boost their competitiveness. CHINAPLAS is located in China with strong influence over the Asian region and the world. The upcoming edition of show will be held in Shenzhen, the city of innovation and creativity. CHINAPLAS embraces the changing times actively, responds to the new demands of the market rapidly, and explores the development of the dual circulation together with the industry stakeholders.

Space reservation of CHINAPLAS 2021 is overwhelming. More than 3,600 exhibitors have confirmed their participation, including 10 country/region pavilions from Austria, France, Germany, Italy, Japan, Korea, Switzerland, United Kingdom, United States and Taiwan region. This shows that the enterprises are with full confidence in the prospect of the plastics and rubber industries. Many forward-looking technologies and practical solutions will be introduced at CHINAPLAS, including cutting-edge technologies from all over the world and strong-rising Chinese technologies.

## New Shrink Film Line for an Enhanced Product Portfolio

■ Etimag is a leading Turkish printer, converter and manufacturer that specializes in shrink sleeve applications. To complement their product portfolio, the daughter company PlasMag Plastik Film Ambalaj Sanayi A.Ş. was newly founded this year. As first strategic action PlasMag now teamed up with Brückner Maschinenbau and ordered a state-of-the-art shrink film line.

The 3-layer MOPET-G line is 4.2 m wide, has a yearly capacity of 6,600 tons and is able to produce shrink films within a thickness range of 20 to 70 µm. According to the plan of PlasMag it will go into production late 2022 at the company’s top-modern premises near Istanbul.

Founder Mehmet Hilmi Okur says: “This investment is a milestone not only for us but for the entire Turkish film and packaging industry and of course also for our region, as this project provides jobs for 80 to 100 people. With this meaning it was clear for us that our project partner has to be experienced and successful in the shrink film business. So, we came together with Brückner and we now see our high expectations completely fulfilled. We are really looking forward to the next project steps.”



Brückner’s shrink film technology for various high-class applications

Helmut Huber, COO Brückner Maschinenbau, adds: “We have been in talks with Etimag for a long time. Now we are very happy and proud that our relationship culminates in this first MOPET-G project for Turkey.”

Brückner Maschinenbau GmbH & Co. KG  
www.brueckner.com

# SMART EXTRUSION

The only website collecting information about smart technologies of extrusion

**34 600 + average monthly visits**

Geographic distribution of Smart\_Extrusion readers, %

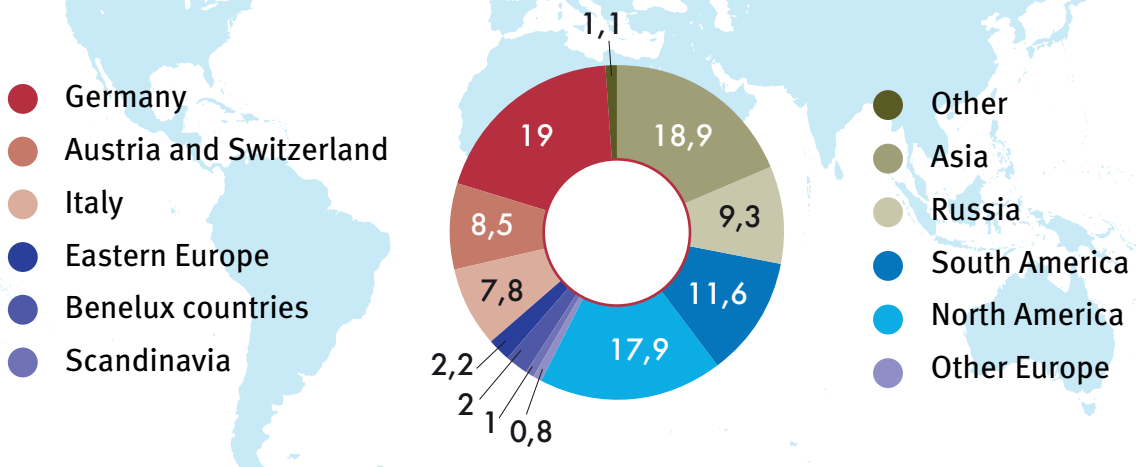

[www.smart-extrusion.com](http://www.smart-extrusion.com)

## Fakuma 2021 – The Course is Set for Circular Economy



■ The next Fakuma international trade fair for plastics processing will take place from the 12th through the 16th of October, 2021. The 27th edition of the event, regarded internationally as the first port of call for injection moulding, extrusion technology, thermoforming and 3D printing, is being eagerly awaited by manufacturers and customers from the plastics industry as a live platform. Amongst others topics, attention will be focused on the issues of sustainability, efficient use of resources and circular economy.

The plastics industry, comprising plastics producers, plastics processors and manufacturers of plastics processing machines, accounts for roughly 6% of all German industrial production. According to the current bvse market report (German Federal Association for Secondary Raw Materials and Waste Management), roughly 421,000 people had jobs in about 3500 companies in the plastics industry with sales amounting to 97 billion Euro in 2019. Key market figures declined during the course of 2020. Above all the recycling market, which serves as an essential basis for successful circular economy, has suffered a noticeable slump.

“Disruptions within the markets have made it plainly apparent that pricing for new materials and recyclates differ,” says Dr. Thomas Probst of the German Federal Association for Secondary Raw Materials and Waste Management (bvse), speaker of the professional association for plastics recycling. “New materials are ultimately linked to the price of crude oil, which is unbeatably cheap at the moment. However, recycled plastics run through the entire recycling sequence including collection, sorting, conditioning and reuse. Through the beginning of 2019, the cost of recyclates and that of virgin material was roughly the same. The gap between prices for new materials and recyclates has widened to an ever greater extent as a result of falling crude oil prices, which have dropped even further due to corona. Plastics recyclers are also suffering from the fact that sorting quality is for the most part in-

adequate, on top of which it continues to deteriorate. The effort required to produce marketable recyclates is increasing as a result.”

Plastics manufacturers and processors are suffering from ongoing disruptions – in particular sales problems, plastics bashing and littering. All of these aspects are linked to each other. “The corona pandemic has further aggravated the situation.” But Thomas Probst knows that a crisis also offers opportunities for reorientation: “Transformation of the plastics industry towards more sustainability has begun.” Probst contends that plastics recycling is a positive factor which generates opportunities and markets worldwide and should be actively communicated.

The next trend identified by Thomas Probst is “Design for Recycling” – D4R for short: Insoluble composites are being used to an ever greater extent in the packaging sector, for example labels and packaging which are fused together. In the case of hollow bodies, for example, a hot paper component is applied to the plastic and the paper fibres are thus included in the regrind. This is where D4R comes in as a favourable trend: D4R is an important instrument for taking the recyclers’ specifications into account.

Meanwhile, many companies have elaborated and advanced their production concepts with regard to automation, digitalisation, networking and efficiency. And thus Fakuma 2021 is being awaited as an outstanding trade fair experience with forward-looking issues and sustainable solutions. Until then, Fakuma-Virtual is proving itself a useful instrument for keeping the professional exchange of ideas and experience up to date with regard to materials, machines, peripherals, processes, simulation, procedures, technologies and tools for plastics processing. But the value of personal contact amongst suppliers and users remains unparalleled.

► P. E. Schall GmbH & Co. KG  
[www.fakuma-messe.de](http://www.fakuma-messe.de)  
[www.fakuma-messe.de/fakuma-virtuell/](http://www.fakuma-messe.de/fakuma-virtuell/)

## Difficult Year for Italian Manufacturers of Plastics and Rubber Processing Machinery

■ The double-digit dip in the import-export markets for the entire period January to September 2020 and the complex economic context due to the world health crisis prompt the trade association AMAPLAST to predict a rather negative year-end result for the Italian plastics and rubber processing machinery, equipment, and moulds industry.

ISTAT foreign trade data for the first nine months of last year, compared to the same period in 2019, show imports and ex-

ports falling by 17% and 14% respectively. The balance of trade, while still amply positive at over 1.3 billion euros, has shrunk by thirteen points.

While improving somewhat after the trough in May, these indicators – combined with the drop in orders among member companies, especially in the first half of the year and particularly in the domestic market – lead the AMAPLAST Statistical Studies Centre to estimate total production for

2020 at 3.6 billion euros, representing approximately -18% with respect to the 4.4 billion in 2019. An analogous result is expected in the consolidated year-end results for foreign trade.

An analysis of export markets by macro-area in the three quarters in question shows strengthening in Europe, especially in extra-EU markets, while Asia and North America have lost ground.

Naturally, these numbers are not surprising given the global economic impact of the pandemic, which does not appear likely to cease in the short term. The new wave of Covid-19 infections in the autumn and winter has incited machinery manufacturers to develop and implement new operating modalities: many Italian companies have successfully introduced complex remote installation and maintenance procedures, ensuring their customers production continuity, particularly in sectors – such as packaging and medical – that have suffered less from the crisis. Moreover, the cost savings deriving from reduced in-person technical service may be an important innovation for the future.

These new work modalities are possible thanks also to the ongoing research and development by the Italian manufacturers in an Industry 4.0 perspective, which makes it possible to offer interconnected machinery for increasingly

sophisticated, custom-fitted production systems. Additionally, increasing computerization makes it possible to collect an enormous quantity of data that will contribute significantly to optimizing production line performance.

While the pandemic has temporarily distracted public opinion and softened negative criticism of plastics, technology suppliers have continued their research into energy-saving solutions for efficient processing of recycled materials within a vision of circular economy. At the same time, the enactment of the so-called “plastic tax”, which has been so worrisome for businesses in the sector, has not been abrogated but only postponed to 1 July 2021.

It is difficult to make forecasts for the new year, mainly because of the uncertainty that continues to surround the pandemic, which conditions markets and companies’ investment planning. A rebound is likely, once again thanks to the impulse from exports, which have always been the mainstay of the Italian plastics and rubber industry, but it is not likely that it will be of such magnitude that we will soon see figures similar to those in the pre-crisis period.

AMAPLAST  
www.amaplast.org



**PLUG IN PERFORMANCE**  
→ POWERFUL FILTRATION



**STRONG STAND-ALONE FILTERS FROM EREMA**

EREMA has been the innovation leader for highly efficient plastics recycling systems for 35 years. Our melt filters are at the heart of them. Robust, safe and with high throughput – even with high degrees of contamination. Filters made by EREMA have proven their reliability for decades in the toughest recycling conditions. With our new brand POWERFIL you can now use our high-performance filters for your existing extrusion system. Plug in experience. Plug in performance.

 EFFICIENT

 ECONOMICAL

 RELIABLE

[www.powerfil.com](http://www.powerfil.com)

## System Components and Controls for Plastics Production



Control and digitalization capabilities from MAAG Group

■ The Swiss-based MAAG Group has been contracted by Belgian company Ravago to install a new line for the recycling of polyolefins. MAAG Group is supplying the line as a complete plant system, all from a single source – including the control technology. The control system comes from XANTEC Steuerungs- und EDV-Technik GmbH, which MAAG Group acquired in 2020. The Ravago contract affirms the Group's strategy of boosting its activities in the field of digitalization and Industry 4.0, offering customers intelligent, agile and competitive solutions.

Founded in 1961, Belgian company Ravago is today a full-service provider to the petrochemical industry, committed to continuous advancement in plastics applications. The focus of the company's diverse operations is on plastics produc-

tion, especially recycling and compounding. Ravago produces 1,000,000 metric tons of plastics annually, at 30 locations.

Various MAAG Group system components form part of the new line: The ERF 500 high-performance melt filter from filtration and recycling systems specialist ETTLINGER is suitable for processing materials with up to 16% impurity levels while guaranteeing long operating times with no filter changing. ERF melt filters can process a wide range of polymers, and effectively remove foreign matter such as paper, wood, aluminum, copper, rubber, silicones, and high-temperature plastics.

MAAG Group's contribution to the line includes an FSC 300 hydraulic screen changer for filtration systems, as well as the PEARLO® underwater pelletizing system. The efficient system, designed for high throughput rates, not only produces highly uniform spherical pellets; its handling, cleaning, assembly and commissioning are also very easy.

The control technology for all line components comes from XANTEC. The new addition to the MAAG Group specializes in the planning, design and manufacture of control systems for the plastics and rubber industry. So it was able to deploy all its expertise and experience in the automation of filtration and granulation systems on the project. For the customer that means optimally designed process control which improves both the cost-effectiveness and the quality of its production.

The new line is scheduled to be commissioned in 2021. The plant design is conceived so that it can also be transferred to other locations of the global Ravago corporation.

MAAG Group  
www.MAAG.com

## Acquisition

■ The British company Atlas Converting Equipment Ltd., a worldwide leading manufacturer of slitting technology for web shaped materials joins Kampf Schneid- & Wickeltechnik GmbH & Co. KG as a part of the Jagenberg Group Industrial Solutions sector.

Kampf and Atlas Converting Equipment provide future-proof machines and solutions with highest level of technology and extensive services for their global customers. The addition of the product ranges of both companies with their highly qualified employees, as well as the clear positioning of the three renowned brands KAMPF, ATLAS & TITAN will further strengthen the joint innovative power and the variety of solutions.

KAMPF, ATLAS & TITAN will continue to serve independently, innovative solutions combined with worldwide services, giv-

ing highest security for their customers investment. The companies will create a new quality in terms of application – and process knowledge as well as automation and digitisation. This will ensure the long term availability of installed machines by offering a common global service that covers all brands, using their strong networks and trusted resources. The business will be expanded by including productivity-enhancing automation solutions and state-of-the-art Industry 4.0 applications to become the global solution provider for the industry.

Kampf Schneid- und Wickeltechnik GmbH & Co. KG  
www.kampf.de

Jagenberg AG  
www.jagenberg.com

Atlas Converting Equipment Ltd.  
www.atlasconverting.com

# High International Rating Received

■ B+ credit rate characterizes R&P POLYPLASTIC as a large business with stable financial state and sufficient safety margin necessary for effective pursuit of activities amid market turbulence.

Andrey Menshov, Managing Partner of R&P POLYPLASTIC noted: "Professional judgement was of critical importance for us. We are actively working not only on import substitution and localization but also on developing export shipments into Europe. This is the reason why we chose to undergo audit in accordance with international standards".

In 2020, the share of export deliveries of R&P POLYPLASTIC to Europe and CIS states amounted to 8% of the total volume of sold products. In 2021, the enterprise plans to further develop its export sales. The B+ international credit rate gives every reason to believe that this goal will be achieved.



**Coface Credit Rate**  
 Aggregated assessment of R&P POLYPLASTIC  
Coface Registration Number : 0000227780027 (OOO "RPP Polplastik")

The assessment was determined on the basis of the in-depth analysis of financial data and non-financial factors of business development of the subject researched. The research was conducted in accordance with Coface standards of credit risk assessment and analysis.

According to specialists, this rate is an excellent result for a Russian enterprise taking into account the period of turbulence connected with COVID-19 pandemic.

**POLYPLASTIC**  
[www.polyplastic-compounds.ru/eng/](http://www.polyplastic-compounds.ru/eng/)

# Precision Wall Thickness Measurement



## RAYEX S XT

- Easy and quick set up for new products
- Fast eccentricity and diameter measurement
- Added longevity due to high-quality xray source



Family owned since 1957, Zumbach is a global leader in the industry. Driven by innovation and experience. We are here for you and ready to build the future together.

## Seamless Commissioning of Systems Thanks to Optimal Preparation on the Digital Twin

■ The commissioning of complex applications and production systems often takes several days or weeks and is associated with considerable downtimes in which the system has to be taken out of production. Virtual development and testing environments can speed up the implementation on site considerably.

The change in control was the optimization of the cycle time on the post-processing station of a Kautex KBB400D blow molding machine in Spain. The new control change initially developed in the Kautex factory in Bonn and tested on a virtual post-processing station (IntelliGate module). It was only then that the commissioning at the customer's production location in Spain was carried out by a service technician on site. The service technician received support from a virtually linked Kautex programmer. The complete process on site with commissioning and final adjustments took only one day. It was therefore possible to restart the system after just half the amount of time that was originally calculated.

Project manager Dirk Hiller of Kautex sees a great deal of potential in the process: "The simulation process which we use for pre-commissioning and testing on virtual Kautex systems reduces time and staffing requirements for the implementation on site. Digital twinning of our machines means that



*Seamless commissioning of systems thanks to optimal preparation on the digital twin (© Kautex Maschinenbau GmbH 2021)*

we are now in a better position to adapt the control of the production system to changing conditions and production requirements more quickly."

■ Kautex Maschinenbau GmbH  
[www.kautex-group.com](http://www.kautex-group.com)

## New Managing Director

■ Tiziano Caprara has taken the position of Managing Director at KraussMaffei Italia. Tiziano Caprara succeeds Andrea Bottelli, who headed the Italian subsidiary initially for the

*From left to right: Davide Pagliarulo, Director Sales New Machines Western Europe; Tiziano Caprara, new Managing Director at KraussMaffei Italia; Tobias Daniel, Vice President Sales New Machines and Chairman of KraussMaffei Italia (Photo: KraussMaffei)*



Netstal brand (now KraussMaffei High Performance) and since 2013 also for the KraussMaffei brand, successfully developing the Injection Molding machinery business in Italy. Tiziano Caprara's expanded portfolio includes injection molding technology as well as extrusion and reaction technology. KraussMaffei's Abbiategrosso site (reaction process machinery) continues to focus on engineering and manufacturing white appliance machines and systems.

"Strengthening our team with Tiziano Caprara fits perfectly with our chosen path of consistently placing the customer at the center of our business, and we are now also tackling this path with momentum in Italy", explains Tobias Daniel, Vice President Sales New Machines and Chairman of the Board at KraussMaffei Italia.

"As Italy is a very important market for us, we will continuously expand our local presence and place our customers even more in the center of all our activities throughout the entire customer lifecycle. Having gained relevant international experience in the industry over the last years, I am glad to dedicate my expertise now to the Italian market," explains Tiziano Caprara.

■ KraussMaffei  
[www.kraussmaffei.com](http://www.kraussmaffei.com)



## Changes in the Board of Executive Directors

■ The Supervisory Board of BASF SE appointed Dr. Melanie Maas-Brunner as a member of the Board of Executive Directors effective February 1, 2021. Maas-Brunner has been with BASF since 1997 and has headed BASF's Nutrition & Health division since 2017. In her new role she will also take over the position as Chief Technology Officer from Dr. Martin Bruder Müller, Chairman of the Board of Executive Directors of BASF. She will assume responsibility for the three research divisions Advanced Materials & Systems Research, Bioscience Research, Process Research & Chemical Engineering as well as BASF New Business at that time.

Wayne T. Smith is leaving the Board as of May 31, 2021. Smith has been with BASF for 16 years and has been a member of the Board since 2012. He is currently responsible for the divisions Monomers, Performance Materials, Petrochemicals, Intermediates, Process Research & Chemical Engineering and North America.

Michael Heinz will take over Smith's responsibilities in North America after a transition period on June 1, 2021, and retain his responsibilities for South America. Maas-Brunner will additionally take over the tasks in the divisions European Site & Verbund Management, Global Engineering Services and Corporate Environmental Protection, Health & Safety as well as the role of the Industrial Relations Director from Heinz on the same date.



Dr. Melanie Maas-Brunner

■ BASF SE  
www.basf.com

## Construction of an Extrusion System in Italy – Bottle Cycle Expediting

*Georg Lässer, Head of Corporate Recycling at ALPLA, considers the investment in central Italy to be a foresighted strategic decision: "We want to promote the bottle-to-bottle cycle and avoid downcycling. In addition, we would like to boost local recycling solutions in a region that does not have the necessary infrastructure for the bottle loop up to now. The demand for recycled material can currently be managed well. But with this measure, we are ensuring that we can offer our customers optimum support with realising new specifications and targets in the long term too and that we can offer them top-quality recycled materials." (Pictures, Copyright: ALPLA)*



■ The ALPLA Group is investing more than five million euros in an extrusion system for food-grade recycled PET (rPET) made of used PET bottles (so-called post-consumer material) at its site in Anagni in central Italy.

Anagni is home to one of the ALPLA Group's most important preform production plants. The plant, which currently has a workforce of 91, processes around 50,000 tonnes of PET a year, of which only a very small proportion is recycled material as of today. But in future a substantial portion of the volume required is henceforth to be supplied in the form of recycled material, giving customers the option of sourcing preforms made partly or even entirely of rPET. To this end, ALPLA is installing an extrusion system for 15,000 tonnes of rPET a year at the existing business premises. It is scheduled to go into operation in the second half of 2021. Ten new jobs will be created.

*The ALPLA Group is investing in an extrusion system for recycled PET at its site in Anagni, Italy*



■ ALPLA Werke Alwin Lehner GmbH & Co KG  
www.alpla.com

## ▶ each detail matters for unrivalled performance

Only a company who has a constant focus on the productivity of its customers thinks ahead and creates extrusion solutions that leave the rest standing. SML specialises in the development of extrusion lines for film, sheet, coating and lamination as well as multifilament spinning lines.

**Extrusion lines.  
Engineered to perform.**

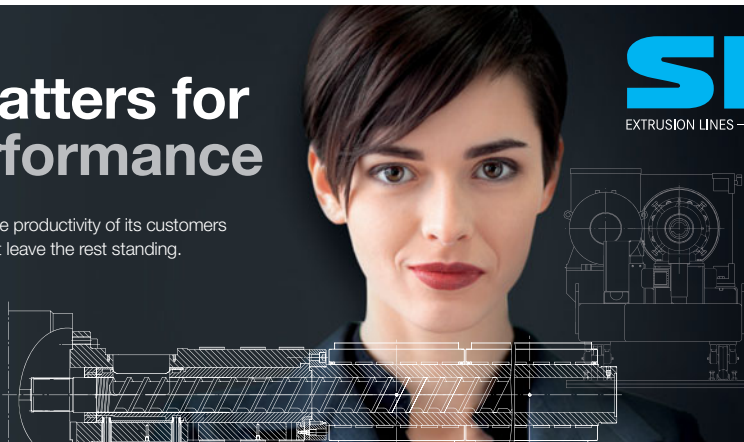

**SML**  
EXTRUSION LINES – ENGINEERED TO PERFORM ▶

www.sml.at

## Investment into Expansion of Production

■ Within the frame of a new investment project, R&P POLYPLASTIC – a Russian plastics producer – and KraussMaffei have recently concluded a contract for the delivery of two ZE 80 x 42D BluePower twin-screw extruders to extend the company's production capacity. Due to travel restrictions caused by the COVID-19 pandemic, both parties conducted the entire contract negotiations online remotely and signed the contract at the end of October. This contract further strengthens the long-standing, constructive and solution-oriented cooperation between R&P POLYPLASTIC and KraussMaffei.

High-tech lines will be installed at the company's production plant in Engels. Investments in only the equipment will amount to 3.3 million Euros.

"In the growing Russian market for engineering plastics, R&P POLYPLASTIC focuses primarily on equipment reliability and technical innovation," says Andrey Menshov, managing partner of R&P POLYPLASTIC. "Faced with a continuously increasing demand, we have to ensure energy-efficient and resource-conserving production while meeting the ever more exacting quality standards requested by our customers. The use of the innovative ZE BluePower twin-screw extruder technology will enable us to maintain the supreme quality of our products in the highly competitive market environment."

Thanks to the installation of the new compounding extruders, the Russian plastics processor will be able to substantially reduce the energy consumption involved in its production. The ZE BluePower twin-screw extruder series is suitable for all compounding tasks – in particular when equipment reliability, reproducibility and flexibility are key factors. The large free volume, the 1.65 OD/ID diameter ratio and the torque density of 16 Nm/cm<sup>3</sup> are especially at-



tractive for plant owners striving to increase productivity. In addition, the extruders are equipped with two side feeders and three degassing zones.

"R&P POLYPLASTIC will use the new twin-screw extruders for the production of engineering plastics designed for the building industry. With this new project, R&P POLYPLASTIC and KraussMaffei continue their long-standing and extremely successful cooperation," declares Siegfried Oldenburger, Expert Sales Extrusion Compounding at KraussMaffei.

New lines are scheduled for set-up and launch in fall 2021. This year will be a milestone for R&P POLYPLASTIC – the leading Russian compounder will celebrate its 30th Birthday.

■ POLYPLASTIC  
[www.polyplastic-compounds.ru/eng/](http://www.polyplastic-compounds.ru/eng/)

## New Sales Area Manager

■ COLINES announced the appointment of a new Sales Area Manager, Paolo Masserano, who has joined COLINES. Paolo has over 15 years experience as a sales manager in a world-

Paolo Masserano



leading company operating in the field of rotogravure printing machines and laminating/lacquering machines. He will be in charge of the following markets: Latin America, Egypt, Jordan, KSA, Libya, Oman, Qatar, Syria and UAE.

"I am very proud to join COLINES and embark on a new journey. COLINES is a world-class company with a family feeling and I am excited for having joined such a team," said Paolo Masserano.

"Paolo has managed to fit in our team very quickly," said Eraldo Peccetti, COLINES' Executive President, "and he is already at full disposal of our customers for discussing and delivering new projects. Our company keeps going from strength to strength".

■ COLINES spa  
[www.colines.it](http://www.colines.it)

## New Exclusive Distributor for PVC Additives in India

■ SONGWON Industrial announced that it signed an exclusive distribution agreement for PVC additives in India with Mumbai-based Makwell Plastisizers, effective as of December 2020. Since starting operations in 1965, Makwell has become a leading player in plasticizers and additives in India with a reputation for high standards and quality.

Commenting on the agreement, Arie Kooij, Leader Market Center Tin Intermediates and PVC Additives, SONGWON said: "With such an experienced partner, we will be very well-positioned to further expand our product availability and increase our level of service to our customers in India. Active in the industry for over 50 years, Makwell has built up a solid reputation and strong local distribution network which will add great value for SONGWON."

"SONGWON's wide range of products completes our product portfolio of PVC additives and we are delighted to be SONGWON's exclusive distribution partner in India," says Amresh Thakker, Marketing Director at Makwell. "SONGWON's strong R&D will also be immensely beneficial to our customers and support them to find the right solutions for their needs. Furthermore, it will contribute to the development of new products required by the ever-changing PVC industry."



(Photo: Songwon Industrial Co., Ltd.)

■ Songwon Industrial Co., Ltd.  
www.songwon.com

Makwell Plastisizers Pvt Ltd.  
www.makwellgroup.com

## Even Closer to Customers



Powerful team players: Jürgen Lochner (CSO/CTO) (left) and Carsten Strenger (CEO)

■ ILLIG Maschinenbau has appointed Jürgen Lochner as Managing Director in the function of CSO/CTO on December 1, 2020. He is responsible for the areas of market and technology with sales and product development for the business units engineering, tooling and service. Together with CEO Carsten Strenger, the management team at the company's headquarters in Heilbronn is well positioned.

The focus at ILLIG is even more on customer proximity and market-oriented products. Structurally, the management continues to focus the company on sustainable solutions, in line with the megatrend Circular Economy, which perfectly serve the needs of global markets.

With the customized packaging development Pactivity® and the tool development Toolsys®, ILLIG develops the solutions of tomorrow for customers. With Circular Thinking, ILLIG supports the economic closed-loop concept and clearly defines sustainability goals: Reduce, Reuse, Recycle, Renew and Separate.

■ ILLIG Maschinenbau GmbH & Co. KG  
www.illig.com

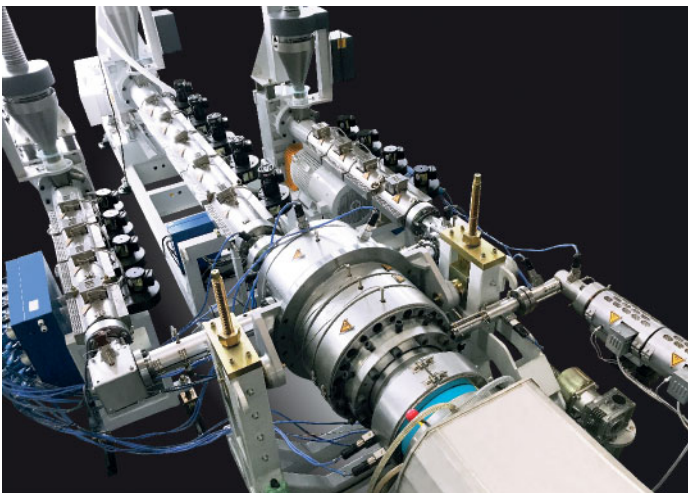



Plastic Extrusion Technology

**20-1200mm HDPE Pipe  
Multi Layer Co-extrusion Technology**

www.ls-extrusion.com  
info@liansu.com

## The Trend is Towards Big Plants and the Highest Quality Recyclate

■ The recycling of PET bottles has gained worldwide acceptance over the past 20 years and has become a model for the circular economy in plastics. This development has been driven forward by EREMA's bottle-to-bottle innovations. The Austrian recycling machine manufacturer has set new standards in this respect time and again, particularly with their VACUREMA® technology, which is the heart of the new VACUNITE® process. As a result, PET bottles with a high recyclate content – a feature indicated clearly on the label – are now an increasingly common sight on shop shelves. The demand for EREMA's innovative PET recycling technologies is growing worldwide across the entire PET segment.

"Despite declining sales of beverages due to the Corona pandemic and a tense situation in the recycling industry accounted for by the fall in the price of virgin material, interest in our PET recycling technologies remains high," reports Christoph Wöss, Business Development Manager at EREMA Group GmbH. One of the reasons for this is the advanced technologies that combine high product safety, stable processes and cost effectiveness. Another reason is that all well-known brand manufacturers, policy makers and society in general are now committed to making plastics recycling and the circular economy work. The EU has set out its position on this topic with targets for recycling quotas and minimum recycling levels in PET bottles.

EREMA estimates the total capacity of all PET recycling machines sold to date for various applications at 2.6 million tonnes per year, with the recent trend pointing clearly towards large-scale systems processing 2,000 kg/h upwards.

EREMA is particularly satisfied with the market success of the innovative VACUNITE® technology, which redefines the benchmark for performance in bottle-to-bottle. In just under two years, the energy-efficient system, developed in cooperation with Polymetrix, has already been sold to 13 customers worldwide. The VACUNITE® process combines vacuum and

*Michael Heitzinger (Managing Director, EREMA) Christoph Wöss (Business Development Manager EREMA Group GmbH) and Patrich Rachinger (Product Group Manager, EREMA) at the site of the new customer centre, where a VACUNITE system for material test runs is being installed (Photo: EREMA)*



nitrogen technology, ensures maximum decontamination efficiency and, with the best rPET colour values, also ensures that higher proportions of rPET are possible in the bottle end product.

Growth is driven by more than the positive development of the bottle-to-bottle sector. Processing PET flakes directly into preforms (flakes-to-preform) or film in a single processing step and especially into recycled pellets for the textile industry (bottle-to-POY) also boosts demand in this segment. In total, EREMA was able to deliver 42 plants with a total capacity of 643,000 t/a within one year between October 2019 and October 2020.

In order to develop and implement closed-loop systems comparable to the bottle-to-bottle cycle for other types of packaging, EREMA is involved in various research projects such as PET2PACK and CORNETPolyCycle. PET2PACK is working on the development of PET rigid recyclates that are approved for use in food packaging.

■ EREMA Group  
erema-group.com

## PLA Compounds – Contribution to the EU Green Deal 2030s

■ As a branch of AKRO-PLASTIC, BIO-FED is the specialist for innovative and application-oriented biocompounds. The product portfolio under the trade name M•VERA® is constantly being expanded with new products. The company is developing and supplying now a wide range of sustainable PLA-based compounds.

The European Green Deal is a concept presented by the European Commission in December 2019 with the aim of reducing net greenhouse gas emissions to zero in the EU by 2050

*Application example of environment-friendly cosmetics packaging*



and thus becoming the first continent to be climate neutral. A 55% reduction in CO<sub>2</sub> is to be implemented already in 2030. With its predominantly fossil-free and sustainable PLA-based products, BIO-FED can offer an alternative material for a large part of packaging applications, for example. The relevant M•VERA® grades can be processed both in the injection moulding process and in the extrusion process.

As a 100% biobased and industrially compostable polymer, PLA is versatile. Possible applications include packaging for food and cosmetics as well as consumer items, such as office supplies or household goods. PLA compounds are characterised by variable stiffness and typically low shrinkage. The

material properties can be individually adjusted by adding different fillers or reinforcing agents and additives.

According to the manufacturer, transparent compounds are also possible. Moreover, biodegradability according to "OK compost INDUSTRIAL" is being sought. The compounds can also be colored with the biobased AF-Eco® masterbatches from the sister company AF-COLOR. These are developed and manufactured in close cooperation by the two companies.

**BIO-FED**  
Branch of AKRO-PLASTIC GmbH  
[www.bio-fed.com](http://www.bio-fed.com)

## Maximising Production Capacity with a Minimal Investment



■ In the current market scenario, marked by a high degree of uncertainty and unpredictability, manufacturing industries need to be able to adapt quickly in order to meet an ever-evolving demand. Today, more than ever before, the complexity of our economy requires a flexible approach to production that involves seizing new opportunities right away and cautiously managing the risks related to technological obsolescence or sizing for future requirements. However, at this time in history, such an arrangement implies that companies need to carefully evaluate which investments can be postponed and which ones need to be made in order to continue to be competitive and, at the same time, preserve a positive cash flow.

In this sense, Bausano – an international leading player in the design and production of customised extrusion lines for the transformation of plastic materials – supports its customers, expanding its offer to include an operating lease service of extrusion lines for producing granules for subsequent moulding, extrusion or calendaring. The aim is to support, by limiting their investments, not only companies that have to deal with peaks in workload but also companies that want to diversify their business. This requirement is particularly rel-

evant in the medical sector, where operators are called upon to upgrade production facilities with extrusion lines for specific processing in order to be able to process an increasingly diverse range of orders.

There are several guaranteed tax, financial and organisational advantages: firstly, according to the IFRS 16 accounting standard, new leased extrusion lines will not be recorded in the assets of financial statements and the lease can be fully deducted. Secondly, in such a rapidly evolving context, a lease is also a great choice in order to always be able to use latest generation technology, especially when it comes to Industry 4.0. Finally, with this solution, the disposal costs of capital goods, which are often not taken into account in the planning phase or are sometimes underestimated, can be reduced.

Bausano has come up with an offer that involves paying a fixed periodic fee for renting the entire extrusion line – except for the cylinder and screws, which are custom-designed and manufactured – which will be purchased and will remain the property of the customer, even if the machine is returned. Also included in the contract is a visit by one of Bausano's specialised technicians who will assist the customer in starting up the plant.

"We are at an unprecedented time in history, which is why we want to be closer to our customers by offering alternative solutions that do not weigh down their lines of credit," says Clemente Bausano, Vice President of Bausano. "We consider an operating lease to be a valuable means of encouraging companies which, for various reasons, have had to postpone investments for purchasing an entire extrusion line, thereby offering them benefits in terms of sustainability and financial stability."

**Bausano & Figli Spa**  
[www.bausano.com](http://www.bausano.com)

## PP Additive for Thermoforming

■ Designed for use by thermoformers, Milliken & Company's Chemical Division's latest high-performance additive for polypropylene (PP) homopolymers delivers an excellent balance of physical properties and superb aesthetics – all enabled through cleaner chemistry.

Hyperform® HPN® 909ei checks all those boxes, and more, as this formulation also addresses an important aspect for safety reassurance in the European Union. Tailored specifically to minimize migration, especially in food-contact applications, this new grade of Hyperform has one Specific Migration Limit (SML) less than the previous generation product. A lower number of SMLs means there is one less substance that must be monitored and tested for, reducing customers' compliance burden. With this simplification, the reassurance of safety is even stronger. This is vital, given that this type of PP homopolymer is typically used to thermoform drink cups and lids, food packaging, and trays.

Traditional nucleating agents require customers to sacrifice impact to gain greater stiffness. Hyperform HPN 909ei, however, delivers improved stiffness (flexural modulus) while maintaining the impact performance. It also provides isotropic shrinkage (similar shrinkage in both directions, thereby



Milliken PP additive for thermoforming uses cleaner chemistry to deliver brighter look (Photos © 2021 Milliken & Company)

reducing warpage) and a higher heat-deflection temperature, which offers improved heat resistance vital for hot-fill and microwaveable applications. It also helps to override the nucleation effects of pigments, thereby reducing design complexity.

■ Milliken  
[chemical.milliken.com/hyperform-hpn-909ei](http://chemical.milliken.com/hyperform-hpn-909ei)

## "Closes The Loop" Pilot Project Eliminates Single-Use Cups

■ Borealis is spearheading an innovative new pilot to test the advantages of a double-closed loop reuse and recycling system, leading the transition towards a more circular economy of plastics, fully in line with its EverMinds™ ambition. Borealis Closes The Loop sees Borealis and its value-chain partners replace the 1.5 million single-use cups used annually at four of its Belgium sites with 30,000 reusable EcoCore® cups. Part of Borealis' mission to Reduce – Reuse – Recycle, the pilot first reduces the weight of plastics through these extremely lightweight cups, then reuses them to maximise their lifetime before seeking to recycle back into cups. This double-closed

loop system is Borealis' latest innovation in driving the circular economy of plastics, expanding their scope up the waste hierarchy towards reduce and reuse, and using their own sites to demonstrate the benefits.

Many reuse initiatives today focus on the consumer, for example reusable cup schemes run by high-street coffee shops. Schemes like this can have a relatively low uptake as the burden is on the consumer to decide whether or not they reuse a cup. In the business environment, reuse schemes are less prevalent and there is widespread consumption of single-use plastic cups. By using a double-closed loop, the pilot aims to make reuse schemes more sustainable and economically viable. Replacing 1.5 million single-use cups with 30,000 reusable cups, weighing 15 grammes per cup, results in a material saving of 4.2 tons of single-use plastic per year.

Findings and learnings from the pilot will be captured, recorded and published to demonstrate how to design and set up robust reuse systems superior to single-use plastics. Borealis will support its customers and value-chain partners with the implementation of further closed-loop systems.

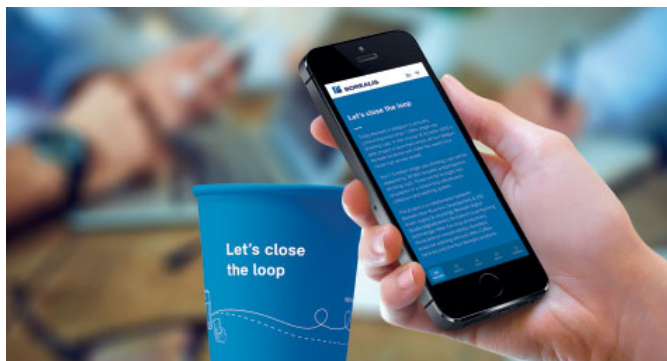

■ Borealis AG  
[www.borealisgroup.com](http://www.borealisgroup.com)  
[www.borealiseverminds.com](http://www.borealiseverminds.com)

# State-of-the-Art Plant for Post-Consumer Plastic Waste Sorting and Advanced Mechanical Recycling Opened

■ TOMRA and Borealis announced the operational start of their advanced mechanical recycling demo plant in Lahnstein, Germany, the result of a partnership that marries chemistry with technology for unsurpassed results.

Operation of the plant is a joint enterprise between TOMRA, Borealis and Zimmerman. Borealis is responsible for the plant’s commercial success and contributes its expertise and knowledge in innovation, recycling and compounding. Likewise, TOMRA contributes as a provider of technology-led solutions and brings its proven expertise, established process and market knowledge which, in turn, enable the circular economy through advanced collection and sorting systems. Zimmerman is a waste management company with experience in sorting multiple types of waste, including plastics, and is responsible for successful plant operations and product quality.

The state-of-the-art plant processes both rigid and flexible plastic waste from households. And unlike many current recycling

*The state-of-the-art plant processes both rigid and flexible plastic waste from households*



*The plant in Lahnstein, Germany, is one of the most advanced mechanical recycling plants when it comes to post-consumer polymer waste (All photos: © Borealis & TOMRA)*

plants, it will produce the advanced solutions necessary for use in high-demanding plastic applications in various industries, including automotive and consumer products. With high purity, low odour, high product consistency and light colour fractions, these Borcycle™ M grade recycled polymers will meet customer quality requirements across the value chain.

The purpose of this demo plant is to generate material for brand owners and converters to qualify, validate and prove fit for use in their highly demanding applications. Technical success will set the groundwork for a commercial-scale advanced recycling plant.

■ TOMRA  
[www.tomra.com](http://www.tomra.com)

Borealis AG  
[www.borealisgroup.com](http://www.borealisgroup.com)

## ColorForward™

■ Avient Corporation, a premier provider of specialized and sustainable material solutions and services, announced that Avient ColorWorks™ has launched ColorForward™ 2022. This 16th edition of the annual color forecasting guide for the plastics industry marks its debut within Avient, which was formed this year from legacy businesses PolyOne and Clariant Masterbatch.

As in years past, ColorForward 2022 presents stories associated with four societal trends that are expected to influence consumers consciously or unconsciously over the next few years. Each trend theme also includes a palette of five associated colors that are predicted to elicit a response from consumers. Developed by a global team, many of whom work in the four Avient ColorWorks design and technology centers around the world, this unique tool has become invaluable to plastic prod-

uct designers and marketing professionals seeking help in making more informed color choices for new products and packaging.

Avient ColorWorks also offers seminars at its four design and technology centers around the world, as well as at selected conferences and customer sites. These can be conducted virtually and/or in-person when appropriate.

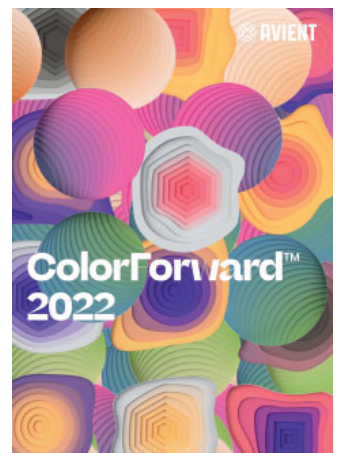

■ Avient Corporation  
[www.avient.com](http://www.avient.com)

## Extrusion Tooling – New Crosshead

■ Guill Tool & Engineering introduces a new single-point concentricity extrusion crosshead that uses micro-fine adjustment screws for precise concentricity adjustment. The precision of concentricity reaches 0.008" or finer per revolution. This single point concentricity adjustment is a unique Guill innovation for the extrusion of thin-walled jacketing and precision ID/OD tubing. One adjustment bolt controls 360° of adjustment.

Features of the single-point crosshead include a patented cam-lock deflector for quick changeovers, with a residence time of one min-

ute at .5 lb/hr material flow, optimized usage with extruders measuring ½" and ¾", and a max die ID of .250."

Additionally, the Guill single-point crosshead offers great flexibility to its users. It not only accepts both vacuum and micro-air accessories, but is also ideal for pressure and sleeving applications. Fluoropolymer designs are available upon request.

■ **GUILLY TOOL & ENGINEERING CO., INC.**  
[www.guill.com](http://www.guill.com)

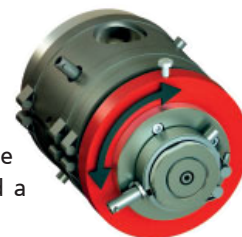

## Divestiture of Screws and Barrels Product Line

■ Nordson Corporation entered into a definitive agreement to divest the screws and barrels product line from its polymer processing systems (PPS) division to Altair Investments (Altair). This divestiture represents a portfolio realignment consistent with Nordson's strategy to drive profitable growth through highly differentiated products serving attractive end markets.

Sundaram Nagarajan, Nordson president and chief executive officer, said: "Using NBS Next, Nordson's growth framework, we are focusing our resources on precision technology solutions that will deliver profitable growth for the company. Our screws and barrels product line is a respected market leader in the polymer processing industry. While this product line no longer fits Nordson's strategic focus, we believe it will do well with Altair. I want to personally thank the employees, who support this product line, for their contributions to Nordson and wish them success in their future with Altair."

Generating over \$70 million in annual revenue with 500 employees, this global product line has been reported in Nordson's Industrial

Precision Solutions segment. Nordson and Altair anticipate closing the transaction in the first quarter of fiscal 2021. They will work collectively to ensure a smooth transition with no disruption to customer service and support.

Joseph Kelley, executive vice president and chief financial officer, commented: "This strategic portfolio transaction will improve the company's ongoing earnings and require a one-time, non-cash asset impairment charge of approximately \$87 million. This action underscores our commitment to align and focus our resources with the best strategic opportunities for long-term profitable growth."

■ **Altair Investments Inc.**  
[www.altairinvestmentsinc.com](http://www.altairinvestmentsinc.com)

**Nordson Corporation**  
[www.nordson.com](http://www.nordson.com)

## Compostable Paper Laminate for Flexible Packaging

■ BASF and the Swedish packaging manufacturer BillerudKorsnäs have cooperated to develop a home-compostable paper laminate for flexible packaging. The multi-layer film consists of three basic components: BillerudKorsnäs' paper ConFlex® Silk, a sealing layer made of BASF's certified home compostable and partly bio-based biopolymer ecovio® and BASF's water-based adhesive Epotal® Eco 3675 X which joins the film to the paper. As all parts of the multi-layer laminate are food-contact approved, it can be used to produce wraps with individually adjusted barrier properties, e.g. for cookies, ice cream, cereal bars and dairy items as well as wrappers for fish,

meat and cheese freshly sold in supermarkets. All components are certified home-compostable according to official European certification schemes for home-composting. The laminate contains a high share of renewables and extends the end-of-life options for multi-layer flexible packaging by being organically recyclable.

The film is suitable for mono and co-extrusion and easy to seal. The sealing is laminated to the paper layer with BASF's water-based dispersion Epotal® Eco 3675 X. This adhesive is certified by DIN Certco as home-compostable according to DIN EN 13432, testing basis NF T 51-800. It can be processed like other adhesives by use of standard lamination machines and shows an excellent performance on different biodegradable substrates.

■ [www.ecovio.basf.com](http://www.ecovio.basf.com)  
[www.basf.com/adhesives](http://www.basf.com/adhesives)  
[www.basf.com/packaging](http://www.basf.com/packaging)  
[www.billerudkorsnas.com/our-offer/packaging-materials/kraft-paper-flexible](http://www.billerudkorsnas.com/our-offer/packaging-materials/kraft-paper-flexible)





# 2021 AdEx Home

Advanced **PIPE EXTRUSION** technology

## WebConference

**14 APR**

Starts at 10 CET

The official language of the conference is English

### Main topics

- *equipment and technologies for plastic pipe extrusion*
- *plastic pipe corrugation technology*
- *software and simulation of extrusion process*
- *extrusion parameter control*
- *extrusion automation*
- *test and lab equipment*
- *temperature control*
- *advanced dies, calibrators*
- *fast tooling and extruder cleaning*
- *material handling and preparation*
- *peripherals*
- *smart materials and additives*
- *recycling*

### Our Moderator

Martina Bönig  
**ing<sup>4</sup>ex.com**  
when extrusion counts



Dipl.-Ing. (FH)  
Kunststofftechnik VDI

Ingenieurbüro für  
Extrusionstechnik M. Bönig

FOR REGISTRATION: [adex-home.extrusion-info.com](https://adex-home.extrusion-info.com)

## Extrusion Coating Line Installed

■ Plastic Coated Papers, Inc. of Pensacola, Florida, installed its second Davis-Standard extrusion coating line. The employee-owned company, which has seen consistent growth over more than three decades, supplies local and international markets with high-quality, customized polycoated products such as polycoated paper, freezer paper, foil coated paper and pre-laminated sleeve stock used in food service, construction, home products and other industries. The new Davis-Standard line complements the company's existing Black Clawson Converting Machinery Division machine, known as "the tank," as the company positions itself for future expansion.

To fully appreciate the addition of the new line, one must take into account the unique history behind Plastic Coated Papers and the existing Black Clawson machine, which is 60 years old. The company got its start in 1986 after founders Dave Mayo (deceased) and Dave Pitts, along with 15 colleagues got together and "pooled their pennies" to start their own business. They were working for paper-coating company St. Regis when the company sold to Champion, resulting in closure of the facility and sale of the company's Black Clawson extrusion coating machine. Mayo and Pitts, along with three other supervisors and 12 production workers decided they knew enough about the business to take a risk and go out on their own. Mortgaging their homes and spending every cent in their private savings, they purchased the extrusion coating line, found a property a few miles down the road, bought the land with a lease-to-buy plan, and built a 10,000 square-foot (930 square-meter) facility. By May of 1986, Plastic Coated Papers was off and running. The company has since expanded its original building to 75,000 square feet (7,000 square meters) and has sales of \$20 million.

"We knew we could make a quality product, had excellent relationships in the industry, and a good polyethylene sup-

*Newest Davis-Standard extrusion coating line with John Clemmons, David Pitts, Sr., Steve Pinette (from left to right)*



*The first purchased Davis-Standard (Black Clawson) extrusion coating line, known as the "tank" with David Pitts, Sr.*

plier," explained Pitts. "Our success was built on a lot of hard work and dedication filled with long hours and many blessings. Our customers came first and we got the machine at a good price. We started production running five days a week, but quickly moved to seven days a week, 24 hours a day. Within five years, we recouped our investment."

Pitts says the machine has been outstanding, only requiring occasional feedscrew, die and barrel replacements. The company will continue to run this line in addition to the new one. The new line will be capable of speeds up to 1,500 feet per minute (450mpm) with maximum untrimmed web widths of 74 inches (1,800mm). Davis-Standard supplied all components including extruder, die with APC, automatic unwind/splicer, pre-corona treater, extrusion coater/laminator, auxiliary unwinds, slitters, post/corona treater, automatic winder/roll changer, Integrator supervisory control system and associated equipment.

The line features the latest automation technology and will add a new level of efficiency and production speed to Plastic Coated Papers' current operation.

According to Plastic Coated Papers current President, Steve Pinette, who has been with the company since 2004, "The new line positions us for the long-term as we support our existing product portfolio and provide even greater customization for our customers in the U.S. and abroad. The current line is a tank, and we know we'll get that same quality with this new one."

■ Davis-Standard, LLC  
[www.polycoated.com](http://www.polycoated.com)  
[www.davis-standard.com/converting\\_system/extrusion-coating.com](http://www.davis-standard.com/converting_system/extrusion-coating.com)

## 50 Years of Global Leadership in Polymer Extrusion and Fluid Coating Dies Celebrated

■ What began in 1971 with a five-person machine shop in a small city of 14,000 is now Nordson Corporation's global EDI® brand, recognized worldwide for advanced engineering and precision workmanship in the production of flat dies for film, sheet, and coating.

The EDI team celebrated the 50th anniversary of the EDI business on February 15, the day of its founding as what was then called Extrusion Dies Incorporated. Nordson acquired the company in 2012 and last year consolidated three EDI operations in Chippewa Falls into an extensive new facility, one that is still in the same town and is still the world headquarters for the EDI brand. Today manufacturing facilities in the US, Germany, Japan, and China support the brand, as do sales and technical service staff located in these and other countries. The global EDI team consists of 350 employees.

Some of the other products developed under the EDI brand are: coextrusion feedblocks that are adjustable on-line and provide variable layer sequencing; multi-manifold coextrusion dies; mechanisms for rapid width adjustment; internal deckles that minimize edge bead formation in extrusion coating; layer-multiplier tooling that yields microlayer structures; film dies

that eliminate tradeoffs between uniformity and melt flow; and multi-layer fixed-lip slot dies.

The founders of Extrusion Dies Incorporated were Jack Barney (president), John Altman (manager of manufacturing), and Darold Schuster (manager of accounting). All three came from the Chippewa Falls firm Johnson Manufacturing, a diversified manufacturer of plastics processing equipment, including dies. The three founders saw a need to focus on dies alone.

Starting in 1971 with two employees, the founders began by reworking existing dies, but within a year they produced their first new dies. Next, by partnering with key extrusion OEMs, which had traditionally built their own dies, Extrusion Dies Incorporated developed a reputation for excellence that was crucial for the company's growth. Today, along with extrusion processors and web converters, equipment OEMs continue to be important customers.

A large number of EDI team members, both in Chippewa Falls and at overseas locations, have been with the brand for many years.

Last year Nordson completed construction of the new world headquarters, a 145,000 sq. ft. (13,500 sq.m) facility not far from the three sites previously used for the EDI business. The facility houses operations for manufacturing, engineering, aftermarket service, sales, technical support, R&D, and laboratory trials. It includes new, advanced manufacturing equipment that streamlines workflow and produces dies with tighter tolerances, and a communications platform that permits close collaboration with EDI teams around the world.

*New EDI® Facility with Nordson Sign*



■ Nordson Corporation  
[www.nordson.com](http://www.nordson.com)

Nordson Polymer Processing Systems  
[www.nordsonpolymerprocessing.com](http://www.nordsonpolymerprocessing.com)

## Expands Global Gate Portfolio for Plastics and Rubber

■ On December 30, 2020, Messe Düsseldorf and Corferias (the International Business and Exhibition Center of Bogota) signed an agreement with Acoplasticos (Asociación Colombiana de Industrias Plásticas) to purchase a share of and jointly organize COLOMBIAPLAST, one of the most important international trade fair for the plastics, rubber, petrochemical and packaging industry in the LatAm region. Accordingly, Messe Düsseldorf – through its subsidiary Messe Düsseldorf North America (Chicago, USA) – acquires an equal share in COLOMBIAPLAST and becomes involved in organizing the event.

Messe Düsseldorf is renowned as the organizer of K, The World's No.1 Trade Fair for Plastics and Rubber, held every

three years in Düsseldorf, Germany. With this agreement, Messe Düsseldorf adds COLOMBIAPLAST to its "Global Gate" portfolio of plastics and rubber trade fairs. Messe Düsseldorf's expertise in organizing plastics and rubber trade fairs around the world together with its extensive network of sales offices and subsidiaries in 141 countries will increase international participation at COLOMBIAPLAST and help to grow the trade show. The next edition is scheduled for June 22 to 25, 2021 at Corferias in Bogota, Colombia.

■ Messe Düsseldorf GmbH  
[www.messe-duesseldorf.de](http://www.messe-duesseldorf.de)  
[www.k-globalgate.com](http://www.k-globalgate.com)

## Acquisition



Steve Maguire

■ Maguire Products has purchased a minority share of O.A. Newton, a provider of bulk material handling systems to the wood-plastic composite, flexible and rigid PVC, and carbon black markets.

Based in Bridgeville, Delaware, O.A. Newton engineers, fabricates, and installs complete systems for the unloading, storage, conveying, and blending of process ingredients, including controls and ancillary equipment. The company will continue to operate separately from Maguire Products, but the investment has the potential to expand the capabilities of Maguire in the material handling phase of the process industries. Maguire supplies handling systems directly connected to the plastics molding and extrusion processes, such as dryers, loaders, blenders, and feeders.

“This investment broadens our offering to the plastics industry and allows us to serve markets that we would otherwise never reach with our current product line,” said Steve Maguire, owner and president of Maguire Products. “We can now refer inquiries for bulk material handling directly to O.A. Newton and can work together with them as projects require.”

Steve Maguire founded Maguire Products in 1977. He has invested in other plastics businesses since then and is a co-owner of Novatec, which, like Maguire Products, is a supplier of auxiliary equipment for molding and extrusion. The two companies operate independently.

“Our affiliation with the Maguire family of companies provides us with access to a sales organization that has a global reach,” said Rob Rider, Jr., president and CEO of O.A. Newton. “It will greatly improve our ability to grow our customer base. The synergies between all the companies will have a compounding effect on all of us.”

For more than five decades, O.A. Newton has been a single-source provider of turnkey material handling systems for customers throughout the world. The company serves the plastics, tire, and other industries, including those processing dry bulk solids and hard-to-handle materials. In plastics it has extensive experience in providing systems for processors of rigid and flexible PVC and wood-plastic composites.

■ O.A. Newton  
[www.oanewton.com](http://www.oanewton.com)

MAGUIRE PRODUCTS, INC.  
[www.maguire.com](http://www.maguire.com)

## Collaboration on First Paving Project Using Recycled Plastic

■ The Plastics Industry Association (PLASTICS) in collaboration with LyondellBasell announced the use of the equivalent of 71,000 plastic retail bags to pave 2,885 square yards of the LyondellBasell Cincinnati Technology Center parking lot in Ohio using recycled polyethylene (rPE). This was the first installation of the New End Market Opportunities (NEMO) for Film Asphalt Project which added over 4,000 pounds of rPE into hot asphalt. With a focus on extending the life of plastic waste, this research project if successful, could be used in paving a future parking lot using 20,000 pounds of rPE or 1.5 million plastic bags.

“LyondellBasell is a proud member of PLASTICS and we have the opportunity to collaborate on innovative projects often in order to advance recycling and sustainability, not only in the U.S. but around the globe,” said PLASTICS’ President and CEO Tony Radoszewski. “Through this unique project, the LyondellBasell team demonstrates how all plastic can and should be used to its highest potential.”

In early June, PLASTICS announced the completion of research on a new formulation of asphalt binder using the “Dry Process”. This is where recycled rPE is incorporated as a solid additive during the asphalt mixture manufacturing process. The formulation offers many of the same benefits of traditional polymer-modified asphalt, including improved performance, and increased lifespan, at a decreased cost.

“We were extremely intrigued by the opportunity to participate and collaborate in this project,” said Chuck Holland, Site Manager of the Cincinnati Technology Center. “LyondellBasell is taking a leadership position in sustainability, and this is one step of many that affirms our commitment in playing an active role.”

The Cincinnati Technology Center is a state-of-the-art research center and encompasses approximately 260,000 square feet of research and office space. This center assists customers in meeting their business and sustainability goals by developing the most efficient and effective polymer mate-

rials required for product performance. LyondellBasell partnered with Colas Solutions, the National Center for Asphalt Technology (NCAT), and Barrett Paving Materials Inc., to bring the project to life.

Colas Solutions is Colas USA technical center, part of the Colas Group, a worldwide leader in transportation infrastructure construction and maintenance. Colas Solutions Cincinnati location and its long experience in the formulation and production of asphalt mixtures modified with rPE using the dry process, provided the opportunity of collaborating with NCAT on this project. Colas Solutions identified an rPE supplier, Domino Plastics; formulated an rPE modified asphalt mixture based on advanced performance testing methods and coordinated production and paving with sister company Barrett Paving.

PLASTICS has long been involved in efforts to further advance traditional mechanical recycling, bioplastics, and responsible stewardship such as the New End Market Opportunities (NEMO) for Film Asphalt Project, NEMO for End-of-Life Vehicle (ELV) Recycling Project, Operation Clean Sweep (OCS), and more.



Parking lot at LyondellBasell's Cincinnati Technology Center using recycled polyethylene (rPE)

Plastics Industry Association (PLASTICS)  
[www.plasticsindustry.org/supply-chain/recycling-sustainability/new-end-market-opportunities-nemo](http://www.plasticsindustry.org/supply-chain/recycling-sustainability/new-end-market-opportunities-nemo)

LyondellBasell  
[www.LyondellBasell.com](http://www.LyondellBasell.com)

## Weatherable Capstocks for WPC Decking

■ New highly weatherable compounds for the outer or “cap” layers of dark-color wood/plastic composite (WPC) decking provide greater durability and scratch-resistance than widely used competing compounds, while helping manufacturers to contain costs, it was announced by Teknor Apex Company. After 5,000 hours in QUV® accelerated weathering tests, Weatherguard® WG-9000 Series polyolefin-based capstock compounds exhibited a color change of less than 0.5 Delta E for dark brown. They offer five- to tenfold improvements in elongation and impact strength in comparison with a standard competing compound, while sacrificing only 15% in tensile strength.



The Weatherguard WG-9015 LG grade contributes to cost containment because it is designed to be used as a 50% concentrate in a blend with a fractional-melt index polyethylene. While ionomer resin is often used as an ingredient in capstocks to increase scratch resistance, the WG-9015 LG grade, when used as a 50% concentrate with polyethylene, provides greater scratch resistance in comparison with a similar compound containing 20% ionomer, while avoiding the need for this expensive polymer.

Made from a blend of wood flour and polyolefin plastics, WPC decking is increasingly popular as an alternative to traditional treated wood because of its superior appearance, lower maintenance, and longer lifespan, noted John Macaluso, Industry Manager, Building and Construction, for the Vinyl Division of Teknor Apex.

The new WG-9000 Series compounds add to an already extensive series of capstock compounds in the Weatherguard product line, including formulations for use with PVC substrates in decking, railings, fencing, siding, windows, and doors, plus other capstock products for polyolefin substrates used in the WPC deck market. Teknor Apex supplies these products on a custom basis, with formulations tailored to customer requirements for color, gloss level, and many other properties.

Teknor Apex Company  
[www.teknorapex.com/weatherguard-pvc-compounds-and-alloys](http://www.teknorapex.com/weatherguard-pvc-compounds-and-alloys)

## Newly Installed Lines Address Swab Stick Demand

■ As COVID-19 continues to spread far and wide, Teel Plastics has risen to the pandemic challenge in an unprecedented way. The custom profile and tubing manufacturer based in Baraboo, Wisc., has quickly become one of the nation's largest and most reliable suppliers of swab sticks for COVID testing. Since March 2020, the company has produced over 500 million swab sticks for U.S.-based customers. Thanks to a recent contract from the U.S. Department of Defense, Teel will boost production in 2021 by adding 66 million extruded and 50 million injected molded swab sticks each month. The company recently installed two Davis-Standard extrusion lines to support the increased capacity. In addition, Teel has been selected to manufacture profiles for a proprietary respirator device used to treat patients in critical care for COVID. These profiles will also be produced on Davis-Standard lines, including a new custom line.

"Before the pandemic began, we were the only U.S. company to make diagnostic swabs needed for coronavirus testing," said Christian Herrild, director of growth strategies for Teel Plastics. "This required us to react quickly to support the surge in test kits. Our development style, product repeatability, and ability to navigate highly regulated markets have been key to our response. Our dedicated employees have done what is necessary to meet very tight timelines, including taking on additional shifts. Our large manufacturing and engineering teams, chemists and analytical lab are definitely a differentiator for us."

*Teel Plastics Medical Swabs*

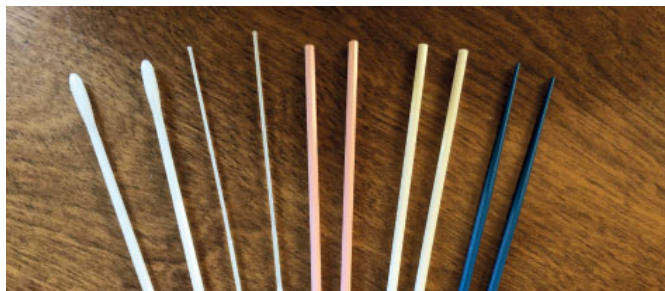

*Davis-Standard Extruders in Teel Plastics' manufacturing facility*

Herrild continued, "We've also been able to rely on our relationship with Davis-Standard. We needed to boost production capacity and Davis-Standard responded to our extrusion needs in record time. They provided us with a demo line almost immediately and two additional lines within 10 weeks from order to delivery."

Teel is a longtime Davis-Standard customer with more than 30 Davis-Standard extrusion lines, some dating back to the 1980s. The newly installed profile lines, extruders through downstream, are application-specific with controls, feedscrews, and machinery customized for Teel's swab stick process. Davis-Standard has supplied Teel with extruders and associated machinery in various models over the years for manufacturing tight-tolerance tubing and profiles in different sizes. These machines process a range of materials including high temperature, water sensitive and custom blended resins for products in the medical, cosmetics, industrial piping, film core and water treatment industries. Davis-Standard has also addressed cleanroom requirements since Teel is a class 100,000 cleanroom capable business.

■ **Davis-Standard, LLC**  
[www.davis-standard.com](http://www.davis-standard.com)

**Teel Plastics**  
[www.teel.com](http://www.teel.com)

## Expansion of Color Concentrate Capabilities in Vietnam

■ Avient Corporation, a premier provider of specialized and sustainable material solutions and services, will complete an expansion of existing production capabilities for color concentrates at its Binh Duong site in Vietnam. The move will improve speed-to-market and service level for local customers seeking unique color solutions to enhance aesthetics and appeal of high-quality end products.

"Demand for plastics has become one of the Vietnam economy's fastest growth areas," says Say-Eng Lee, vice president and general manager, Color & Additives Asia for Avient. "As consumption grows, requirements for high-quality color concentrates

are becoming more challenging as well, as top brands focus on novel color solutions. We have increased our production space by over 30 percent and added to our state-of-the-art machinery portfolio to shorten lead times for developing and produc-

*Avient to Expand Color Concentrate Capabilities in Vietnam (Photos: Avient)*



ing high-quality color concentrates. As a result, local customers will benefit from an efficient and agile setup, along with expert technical support. In addition, we can be more responsive in accelerating customer development times and help them to reduce time to market."

According to Vietnam Economic News, Vietnam's plastics industry is currently experiencing an annual growth rate of 16 to 18 percent, with key segments including packaging, construction and electronics. Avient's enhanced local turnaround for color concentrates will support middle to high end markets with consistent color quality, creative application of special effects, and unique colors to enhance product appeal and match branding requirements. With the expansion, Avient will also improve lead times for color matching locally.

Notably, Avient's sustainable color concentrates can also support steps within the country to encourage plastic waste recycling and reuse. For example, the use of recyclable CESA™ IR additives, which enable black plastics to be identified for recycling, can reduce the environmental impact of dark colored packaging. Avient also recently strengthened its global commitment to help customers tackle and overcome the challenge of plastics



Vietnam site

recycling with the official opening of its new CycleWorks Innovation Center in Italy. The new center will focus on facilitating partnerships and enhancing new technologies to further the viability of recycling.

Avient also offers color concentrates for biodegradable plastics PLA, PHA, PHBV, PBS, PBAT and special blends of those materials, which do not compromise the organic recyclability of the resins they enhance.

Avient Corporation  
www.avient.com

## Market Development Manager for Pelletizing Systems Appointed

■ Curtis Hatchitt has joined Nordson BKG as market development manager for pelletizing. He will focus on expanding the market in the Americas for BKG® pelletizing systems.

"Curtis brings more than 25 years of experience with manufacturers of resins and compounds, giving him a deep familiarity with companies that use pelletizing systems such as ours," said Kevin Tuttle, General Manager, Americas. "His background includes serving customers in Mexico and Central America, which are key markets for BKG products."



Curtis Hatchitt

Hatchitt's most recent positions were those of general manager at Vortex Liquid Color and vice president of sales at ANCOS. For ANCOS he developed markets for polymer finishing systems used by resin manufacturers. Previously he held positions of increasing responsibility for DuPont, DSM Engineering Plastics, Washington Penn Plastics, and Sabic.

## Vice President Appointed

■ Jesus Crespo has joined Nordson Corporation as vice president leading the Polymer Processing Systems (PPS) division. He brings twenty years of executive experience in industrial management.

Nordson's PPS products include BKG® pelletizers, melt pumps, and melt filtration systems and EDI® polymer extrusion and fluid coating dies. The PPS division is now part of the Industrial

Precision Solutions (IPS) segment of Nordson, formed in 2020 in a corporate business realignment and headed by Gregory P. Merk, executive vice president. "Jesus has a proven track record of leading division-level transformations that revitalized businesses and drove organic growth," said Merk. "He will focus our best resources to bring product and service innovations that make our customers more successful." Crespo's appointment follows the announced retire-

ment of John J. Keane, executive vice president, who is retiring after nearly 30 years with Nordson.



Jesus Crespo

Nordson Corporation  
www.nordson.com

Nordson Polymer Processing Systems  
www.nordsonpolymerprocessing.com

# Reciprocating Head introduced – Automated Extrusion Process Drastically changes the Extruded Profile

*Guill Tool has released its new reciprocating head. The traditional tip and die assembly is replaced with a linear reciprocating assembly that changes the tube's profile within a given length. This process is repeated throughout a single extrusion run without interruptions. Cutting capability, in association with the extrusion speed, cuts the finished product to length*

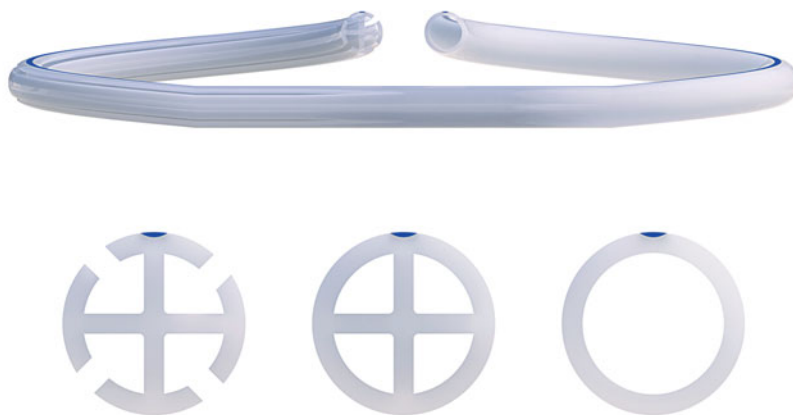

While cost and value stream activities are reduced, quality is improved. Only one extrusion run is needed to produce a finished product, as opposed to multiple extrusion runs with tooling changes along with a manual assembly operation to connect different tubing shapes. Guill's new reciprocating head eliminates an assembly operation. It also eliminates in-process inventory. Thus, there is no need for storage of various tubing shapes and connectors

needed for assembly, fulfillment of orders and replenishment of finished goods.

Furthermore, the reciprocating head eliminates a connecting piece, allows JIT production and products made-to-order. Lastly, it reduces total run time from receiving the order to shipping.

#### **New 500 Series Rubber/Silicone Extrusion Crosshead**

Guill Tool introduces the NEW 500 Series crosshead with MAGS gum space adjustment. The 500 Series is designed specifically for the flow characteristics and unique processing challenges of elastomeric compounds. One of the key features engineered by Guill on this new crosshead design is the mechanically assisted gum space (MAGS) adjustment system. This new method of gum space adjustment allows the operator to make an effortless adjustment from a single point using a common socket wrench. No more need to struggle with multiple nuts and bolts in order to adjust gum space, which leads to faster adjustments. The visual indicator on the core tube allows the operator to see how far the gum space has been moved, making those adjustments much more accurate and repeatable.

The hardware-free and patented cam lock design of the NEW 500 Series from Guill means no time is wasted unbolting and re-securing fasteners for disassembly and re-assembly. Only half of a rotation of the cam nut is required to loosen and automatically extract the deflector from the head body, which is another time saver. Also, with no undercuts on the deflector, there are no mate-





rial hang-ups when extracting the deflector, allowing for faster and easier cleaning and changeover. The NEW 500 Series also features the latest Center-Stage concentricity adjustment system that significantly reduces pressure on the tooling, allowing easier and more precise concentricity adjustments without loosening the face bolts. Easy-Out inserts for the adjusting bolts also allow simple replacement of locked or damaged adjusting bolts, which further saves on repair and downtime. Another innovative feature of this new rubber/silicone crosshead is a cast aluminum liquid-fed cooling sleeve that allows the user to switch out the cooling jacket in the event of a line obstruction, again reducing downtime compared to traditional integrated cooling systems. The NEW 500 Series crosshead with MAGS gum space adjustment is a drop-in replacement on most existing NRM lines, however this crosshead design can also be adapted to fit any extruder design or line layout. The addition of a newly designed flow inlet channel reduces the shear and heat that is generated as the materials are being processed. This leads to lower head pressures allowing the material to move through the head in a much more balanced and even flow. All crossheads supplied by Guill are furnished with a tool kit for assembly and disassembly as well as a detailed op-

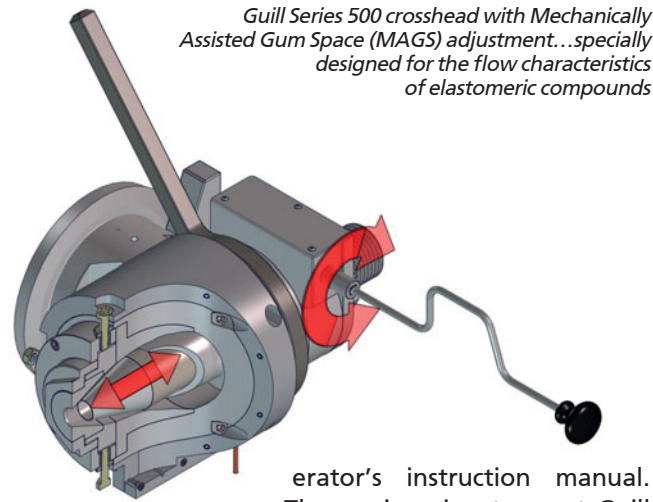

erator's instruction manual. The engineering team at Guill will assist users in the implementation and operation of the NEW 500 series crosshead. For a video of the NEW Guill 500 Series crosshead with MAGS gum space adjustment, please go to: <https://youtu.be/jeNovmMtcBs>

Guill Tool & Engineering Co., Inc.  
[www.guill.com](http://www.guill.com), [sales@guill.com](mailto:sales@guill.com)



recycling to the  
**next level**

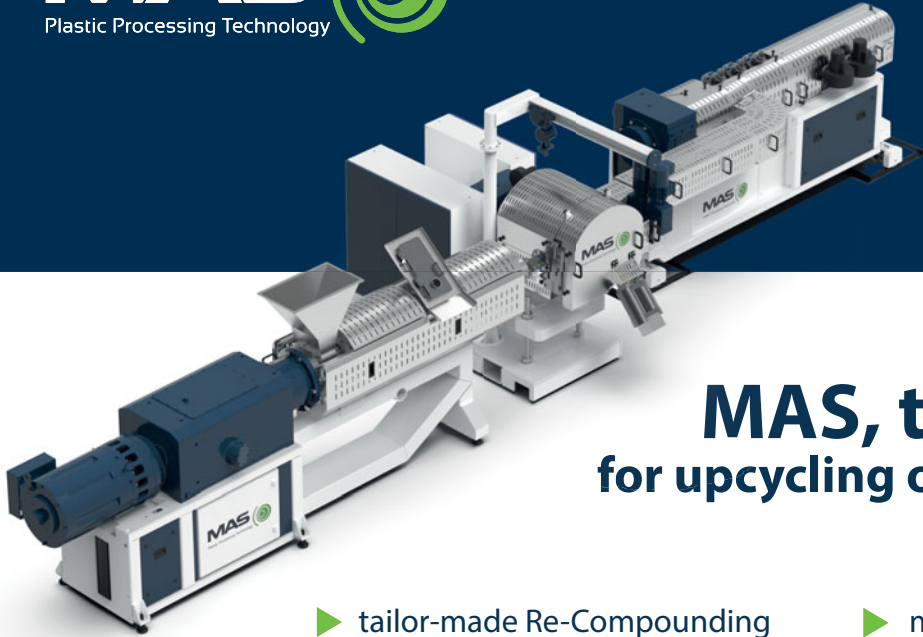

## MAS, the Trendsetter for upcycling of plastics

- ▶ tailor-made Re-Compounding
- ▶ extraordinary flexibility
- ▶ modular & automatized production lines
- ▶ Recycling for your profit

*Silage film produced on SML's MiniCast stretch film line*

*Newly developed formulations from SML make it possible to manufacture high-quality silage film on its cast stretch film lines. Compared with the manufacturing of blown silage film, this new approach offers some key advantages: higher output capacities, significantly lower production costs and the possibility to optimise the relevant film properties*



## Silage Film for Bale Wrap

Silage films are primarily used in agriculture to preserve bales of silage, hay and maize. Wrapped around the bales, silage films prevent over-fermentation processes and maintain the nutritional value of the contents. To ensure easy bale wrapping and proper protection throughout the entire storage period, the quality requirements of these films are relatively high. So far, silage film was mainly made from blown film as the right dart impact, cling level and oxygen permeability could be more easily achieved than with cast film. This is now changing.

In cooperation with premium material suppliers, SML recently developed a silage cast film for bale wrapping that meets expectations in terms of its properties and even beats the blown product. "Our major concern was the higher oxygen permeability of our cast film," Thomas Rauscher, Product Manager at SML, remarks. The market-conform value for the oxygen permeability of silage film should not be higher than  $9,000 \text{ cm}^3/\text{m}^2 \cdot 24\text{h}$ . "In the past, a typical cast stretch film of 25 micron displayed a value above  $10,000 \text{ cm}^3/\text{m}^2 \cdot 24\text{h}$ , whereas due to the latest development we achieved

values of around  $8,500 \text{ cm}^3/\text{m}^2 \cdot 24\text{h}$ ," Thomas Rauscher explains.

Typically, silage film made on SML's cast film line has at least 5 layers. The claim to fame of the silage film for bale wrap is that the cling layer has to be at the outside of the roll and the "stickiness" has to be very high, whereas a good cling level is between 5 and 10 N/m. "During the cast process, it is an easy task to put the cling material on the outer side of the roll. And we have several possibilities to guarantee a high stickiness," Rauscher says. The cast film line can either produce the film with PIB in liquid as well as in granule form, whereas the preferred process nowadays is without liquid. Additionally, the high cling level can also be reached without PIB. This solution reduces the handling cost, since silage film on a PIB base normally needs to "rest" at least 48 hours in a heated storage room. The cling value of the PIB-free cast silage film was tested at 8 to 9 N/m.

The layer on the other side of the silage film has to have a high slip. The 'slip layer' helps to ensure that the wrapped bale does not get damaged during the stapling and storage pro-

cess. As usual, the UV masterbatch is also added to this layer. The UV additive protects the goods against damage caused by sunlight.

The properties of the inner layers of the silage cast film guarantee the right dart impact and stretchability. "The dart impact of silage films should be at least over  $10 \text{ g}/\mu\text{m}$ , while the tested cast films reached values of more than  $15 \text{ g}/\mu\text{m}$ ," Thomas Rauscher comments. Silage film usually requires a stretchability of between 50 and 100 %. "For a cast film, this is not an issue and so all the tests produced results exceeding the required stretchability by far, based on 750mm wide rolls," Rauscher explains.

SML's cast film lines do not only produce silage film, which is a seasonal business: the same lines also manufacture conventional stretch wrap film. With the cast process, manufacturers are able to raise the utilisation rate of their extrusion lines further which also has a favourable impact on the profitability.

**SML Maschinengesellschaft mbH**  
Gewerbepark Ost 32, A-4846 Redlham,  
Austria  
[www.sml.at](http://www.sml.at)

# BOPP and BOPE Inline Coating – Perfect Barrier, Improved Recyclability

*Driven by the discussions about recycling targets for plastic packaging, mono-material packaging structures are receiving more and more interest: for example, biaxially oriented polypropylene (BOPP) or polyethylene (BOPE) films. Reasons for this are a better sortability of the packaging and an improved quality of recycling materials. With mono-material structures the question of barrier solutions and their role for recycling comes up. If one looks at traditionally used aluminum metallized films or aluminum foil, future packaging designs demand a transparent barrier solution like AlOx, SiOx or EVOH*

Here the inline coating technology offers decisive advantages for BOPP and BOPE applications. Brückner's newly developed technology is installed between the machine film orientation (MDO) and the transverse film orientation (TDO) process: A wet chemical treatment applied there directly inline provides a tailored base-layer (primer) for the subsequent AlOx/SiOx metallizing step and can be used at regular 3-layer BOPP or BOPE film stretching lines.

The metallization layer is a perfectly bonded, very homogeneously distributed over the complete film width and shows outstanding oxygen and water vapor barrier values – comparable even to high-barrier films such as metallized BOPET or aluminum foil. Since the coating material is water-based, transparent and in nanometer scale (typically < 100 nm), the environmental impact and effect to the recyclability is minor and thus within the strict laws and regulations. It is even superior from an economical point of view to any barrier so-

lution with EVOH. Besides this, the treatment is long-term stable without decay.

## Benefits of inline coating at one glance

- Huge variety of possible applications and film types
- Cost efficiency
  - Thinnest, very consistent coating layers in the nanometer scale (< 100 nm): Low coating material costs
  - No additional corona treatment needed on coated surface
  - Low investment costs due to the narrow coating width before transverse orientation
  - Utilization of the transverse orientation unit's pre-heating zone as dryer: energy optimized process without separate dryer
  - Low operation costs by saving expensive off-line coating processing steps
- Enhanced film properties
  - Improved bonding of the coating to the film in the virgin, not yet crystalline state – superior to offline-coating
  - Improved printability
  - Significantly higher metal adhesion – perfect barrier improvement after metallization (Al / AlOx / SiOx)
  - Antifog and antistatic layers
  - Long term stable surface energy
  - Improved recyclability due to lowest impact of the thin layer technology

The inline coating technology is not only available with new Brückner film stretching lines but can also be upgraded on used lines. Brückner Servtec has a complete concept for the line modification:

- Tailored upgrade package for existing BOPP film-production lines
- Full integration in the existing control system
- All necessary modifications of existing components to run inline coated film

Film producers going that upgrading step profit from Brückner Servtec's know-how of coating formulations and process, the experience of more than 40 installed Brückner inline coaters for BOPET and BOPP, the comprehensive R&D resources at the Brückner headquarters as well as a network of corresponding partners in the industry.

Brückner's inline coating technology



*Bausano, an international leader in the design and production of customized extrusion lines for the transformation of plastic materials, announced the introduction of its next generation lines of twin-screw plastic extruders in the U.S. and Canadian markets. With world-renowned "Made in Italy" quality and unrivaled technological innovation, Bausano's two renewed product lines – MD Plus and MD Nextmover – are best suited for several types of extrusion, pipes, granules, wood plastic composites (WPC), profiles and materials used in the medical industry*



# Next Generation Lines of Twin-screw Extruders Introduced in the U.S. and Canada



Bausano's twin-screw extruder lines are noteworthy for their unique, patented Multidrive transmission system, a careful study of interpenetrating and counter-rotating screw geometry and the newest motor generations and tools for consumption analysis, all of which combine to deliver high levels of efficiency, durability, reliability and sustainability.

"Our extrusion lines are the result of advanced engineering that combines innovation with

more than 70 years of know-how in plastic transformation processes," said Clemente Bausano, vice president of Bausano. "Our Multidrive system has increased the efficiency and the service life of our machinery, undoubtedly setting a new high standard in the extrusion industry for both. Our approach to design and development, production, assembly and testing steps ensures the highest technical and functional quality standards, and we're very excited to introduce our next generation lines of twin-screw extruders to the U.S. and Canadian markets." Bausano's Multidrive technology is the result of the company's many years of research and experimentation. With a unique design that substantially reduces stress on motor shafts, gears and screws thanks to the tightening torque strain being distributed on two pairs of motors, Multidrive delivers higher power on screws equal to the power delivered to increase precision and reduce energy use. Compared to traditional systems, Multidrive's innovative distribution of motion also reduces the likelihood of faults due to excessive stress on mechanical components, which ensures a lon-

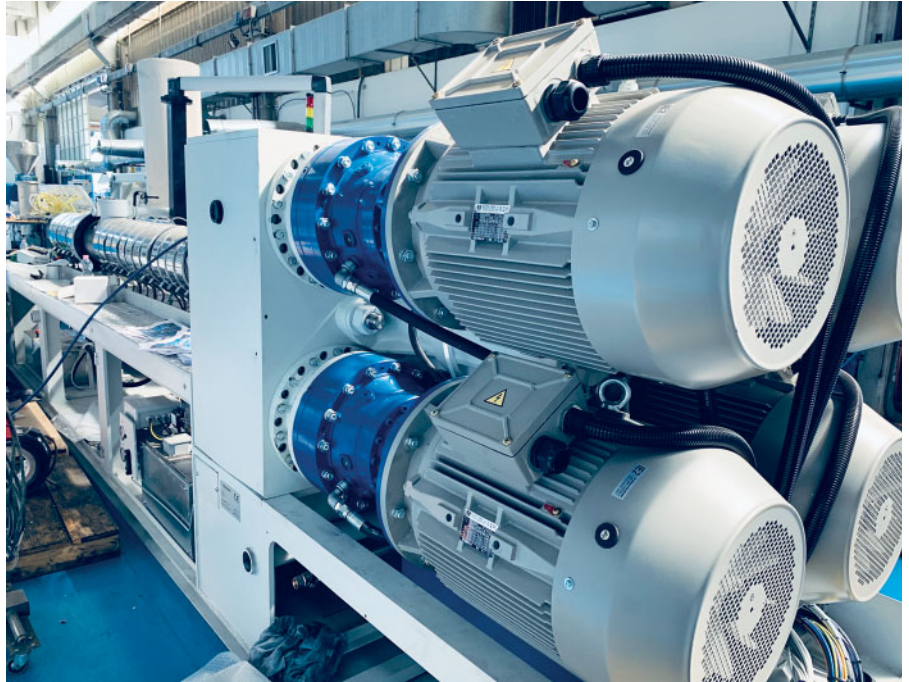

ger average service life of the machine – motors are managed by a single static frequency converter, an instrument capable of ensuring constant rotation and perfect synchronism, without using any additional devices. The MD Nextmover line features an all-new Digital Extruder Control 4.0 system with a capacitive, multitouch, panoramic screen. It performs continuous screening of

the system by processing reports and graphs in real time to easily and precisely analyze extrusion parameters and consumption at each stage of the production cycle. MD Nextmover also includes an innovative Smart Energy System for contactless cylinder heating. By using an alternating electromagnetic field, the new system delivers a significant reduction in wear-and-tear while delivering energy savings of up to 35%. Both twin-screw lines also feature special multi-stage thrust bearings, which are designed to triple the dynamic load and enable the extruders to handle high volumes of production. For smaller lines, Bausano has developed Multidrive 2x2, which features a single pair of motors to reduce overall dimensions while optimizing gearbox operation.



# Investment in Austrian Recycling Technology

*Although plastics have been used on a larger scale for more than 100 years, they are, in contrast to metals, glass or paper, only very hesitantly perceived as valuable materials that are worth recycling. Too often, plastic products end up after use in a landfill or in an incineration plant. Only the realization that plastics are of such high quality and durable that they do not disappear on their own when they end up in the environment has led to a rethink. This is also the case in Indonesia, where the Pan Era-Group has specialized in the recycling of polyethylene and the manufacture of carrier bags and packaging bags from it. The Pan Era Group relies on high technical standards and, after extensive preliminary tests, decided on a recycling line from the Austrian extrusion technology company MAS.*



Picture 1: Director Wilson Pandhika is heading the Pan Era Processing Division, which is among the leading recycling companies in South-East Asia (Photo: Pan Era)

The Indonesian family company Pan Era Group with its headquarters in North Jakarta is a group of companies active in multiple business sectors, one of them is the recycling of post-consumer plastic waste and processing it into film products. The founding of the company dates back to 1989 when its founder started grinding and washing several types of plastic waste, becoming one of the early players in this field. The company then progressed to producing recycled pellets and subsequently, in 1997 it then started producing plastic shopping bags and packaging film made from recycled material. Ever since, the company has stayed true to its roots and has always used recycled material. To date, more than 95% of the plastic bags produced and sold by Pan Era Group are made using at least 80% recycled content. And it has achieved a market leader position, and is one of the most sought-after products on the market. This indicates that the group possesses excellent knowledge of the recycling process as well as firm dedication to quality.

*Picture 2: Pan-Era Group produces in a one-stage-process particle-free HDPE-qualities in different colors, suitable for producing new high quality packaging films (Photo: Pan Era)*



Following years of continued growth, the company then expanded to Cikarang in the province of West Java, in 2011. Production quickly ramped up and within several years, the group has already used up almost all of its capacity. Currently this facility is one of the most prestigious recycling plants in the region, drawing praise from many of its visitors, as Pan-Era Director Wilson Pandhika confirms. (Picture 1)

The group is now progressing on one of its most ambitious growth steps so far, which is the establishment of yet another plastic recycling plant in Cikande, about one and a half hours drive from the Indonesian capital of Jakarta. The new facility is projected to be one of the largest Polyethylene recycling plants in South-East Asia. (Picture 2 to 4). It is at this new location that Pan Era Group relies on Austrian recycling competence and has ordered an ES-compound extrusion line with an output of 1000 kg PE per hour from MAS.

## The "plus" of the MAS-extrusion-technology: The gentle polymer plasticization

MAS stands for innovative extrusion technology, especially the conical twin-screw-extruders with co-rotating screws. They are available in six sizes, from the MAS 24 laboratory extruder with an hourly output of 10 kg PE up to the high-performance extruder with an output of more than 2,000 kg/h. The range is supplemented by the CDF-melt-filters with very efficient, rotating disc filters and the DRD-centrifugal-cleaners for the pretreatment of input materials, especially for drying and the waterless separation of solids.

Based on the co-rotating screws, the conical MAS-extruders offer a specific property profile that makes them ideal for complex recycling and compounding tasks. Outstanding is the very uniform plasticization at a comparatively low to medium pressure and shear level, documented by measurements of the physical product characteristics. Their analysis show that the qualities of the input material stay at maximum after processing which is of decisive importance for both recycling applications and compounding tasks. Thanks to their modular structure, the screws can be easily and quickly fine-tuned to a specific task by exchanging individual screw-segments.

Another advantage is the system-specific large feed opening on the extruder, which favors the feeding in of material with a low bulk density, such as recycling flakes or fibrous and powdery additives in compounding technology.

**MAS-ES compounder for multi-stage melt cleaning by means of degassing**

High up on the Pan Era Group’s project specification was the ability to produce in an one-stage-process a particle-free HDPE in different colors, suitable for producing new high quality packaging films or various bottles for detergents or other household chemicals.

The area sales manager of MAS, Juergen Morosz comments: “The challenge was to correctly assess the input material in terms of its composition and degree of soiling and the system design required for processing. In close cooperation with the customer, after a series of representative material tests, we have found a process technology solution that optimally uses the potential of the MAS extruder. The ideal solution was, respectively is, a system concept derived from our ES compounder extruder cascade. It consists of a single-screw extruder for melting and plasticizing the washed and dried PE flakes and a subsequent CDF 500-D twin disc filter unit from our supply program, where particles with a fineness of 130 µm are retained and segregated. The thus cleaned material stream is then fed to the conical MAS twin-screw extruder by side-feeding in the area of the feed zone. But that was not enough cleaning. There were still printing ink residues and odor emissions in the melt. In order to remove these contaminations we have added a vacuum unit to the specifically large intake opening of the twin-screw-extruder and converted it into a degassing zone, where the

Picture 3: General view of the Pan-Era production of film packaging-bags (Photo: Pan-Era)



volatile melt components can be sucked off efficiently. From there the polymer melt is conveyed further, compressed gently and homogenized until it finally reaches a second degassing zone for second cleansing (Picture 5). Passing an MFI-measuring station, it finally reaches the granulating unit.”



Picture 4: Examples of product of Pan Era Group made from at least 80% r-HDPE (Photo: Pan Era)

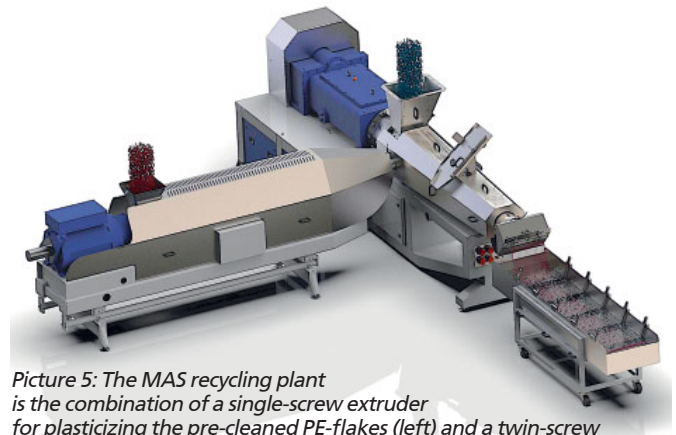

Picture 5: The MAS recycling plant is the combination of a single-screw extruder for plasticizing the pre-cleaned PE-flakes (left) and a twin-screw extruder for efficient degassing and the potential for up-cycling through compounding with additives (Photo: MAS)

As an additional bonus, the system concept also offers the compounding ability which actually is used to achieve high degree of homogenization of the recycled resin. As it is the core property of the ES-compounder systems, there is the intention to use it for extending the scope of materials to compounded materials for technical applications. To do this, the feed zone of the MAS twin screw extruder only needs to be combined with a vacuum lock through which powdered additives such as talc or calcium carbonate can be added without the need for additional side feeder units. This means that Pan Era Group has every opportunity to expand the r-HDPE range to include material variants for technical applications.

Author:  
Reinhard Bauer - TECHNOKOMM  
office@technokomm.at

MAS Maschinen- und Anlagen Schulz GmbH  
A-4055 Pucking, Austria  
Juergen Morosz – MAS –Area Sales Manager  
E-j.morosz@mas-austria.com  
www.mas-austria.com

# External Inspection Solution for Highest Polymer Quality

*OCS not only designs tailor-made (laboratory) extrusion lines to the individual specifications and needs of customers as an overall concept, but also offers external inspection monitoring for OCS third-party extrusion lines. The external Film Surface Analyser (FSA100EXT) is an optoelectronic inspection system for polymer film and provides real-time defect analysis with customer-specific result display*

Inspection technology increases product quality. Upgrading the existing extrusion line with the external Film Surface Analyser (FSA100EXT) optimises quality control in the polymer production process. It thus contributes to a significant improvement and assurance of product quality. Some renowned polymer manufacturers use this extended form of control and assurance in their production lines. The customised frame allows easy and quick adaptation into the existing plant at customer side.

## **Optimal defect detection at the highest level**

State-of-the-art camera technology is concealed in the customised OCS frame. The advanced V2 camera technology consists of a high-resolution dual-line CMOS camera and a user-specific high-performance LED. This combination enables optimal defect detection in transparent, opaque and coloured polymer film. With the OCS FSA100 software, the measurement results are analysed according to customer-specific specifications

*OCS FSA100EXT LED lighting*

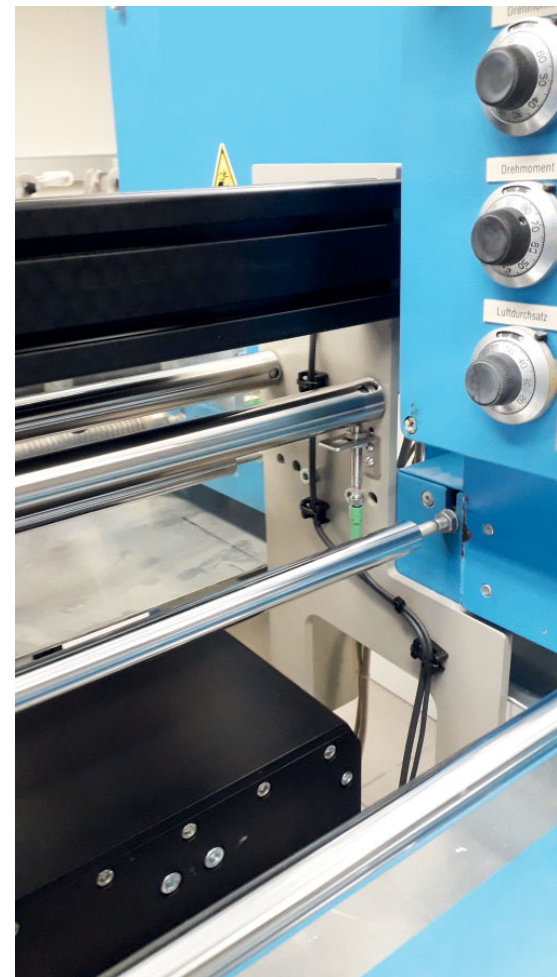

*OCS FSA100EXT implementation*

and the defects are classified accordingly, providing information about the film quality.

**OCS Optical Control Systems GmbH**  
Wullener Feld 24, 58454 Witten, Germany  
[www.ocsgmbh.com](http://www.ocsgmbh.com)



*Non-recyclable plastic is one of the problems of the present. Various technologies ensure the re-use of plastic products and their separation in waste processing. But the loss rate incurred in this area is still high. In the first place, plastics cannot be recycled and re-used indefinitely. Secondly, separation of pure homogeneous materials often presents a problem which leads to large quantities of non-reusable mixed fractions. These are normally burnt or disposed of on landfill sites*

Renasci plant



# Oil from Plastic Waste

## High-speed extruder melts and degasses granulate from used plastic

However, latest research findings have opened up a possibility to extract oils and fuels from this no longer usable plastic once more. In this way, the material cycle can be closed again by returning the oils gained by this method to the chemical and petrochemical industries.

The Dutch company Petrogas – Blue Alp, domiciled in Eindhoven, has developed a production plant for this process over several years and commissioned it for Renasci, located in Oostende, Belgium. In this process, the starting material (used plastic) is first collected and shredded, then its ingredients are analyzed. Next, undesirable foreign substances are filtered out, and the material is dried. By renewed agglomeration, a starting material is created in the form of a granulate.

This granulate is melted by battenfeld-cincinnati high-speed extruders and degassed via vacuum zones. In this way, volatile foreign substances are extracted and pumped off separately. The high-speed extruder is particularly well suited for this purpose, since its compact design in combination with

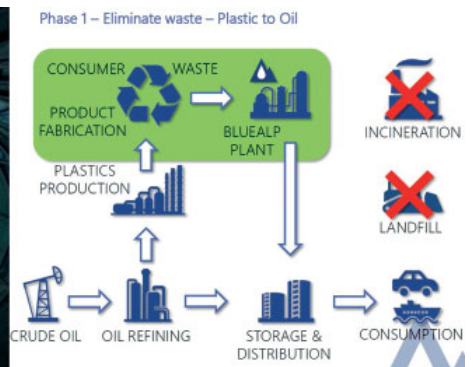
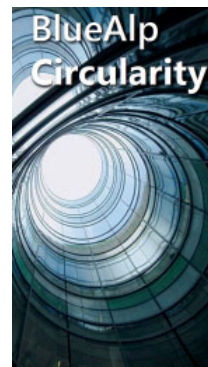

BlueAlp Circle

a powerful transmission drive ensures a high output. These two advantages were decisive factors in the design of the entire system. An additional benefit is this extruder model's user and maintenance friendliness. battenfeld-cincinnati specially developed a new processing unit and screw geometry for this application.

Downstream reactor units then split up the melt delivered by the extruder into its individual components.

Highspeed Extruder



**Blue Alp**  
[www.bluealp.nl](http://www.bluealp.nl), [www.petrogas.nl](http://www.petrogas.nl), [www.renasci.be](http://www.renasci.be)

**battenfeld-cincinnati**  
[www.battenfeld-cincinnati.com](http://www.battenfeld-cincinnati.com)

*If inhouse waste and heavily contaminated post-consumer waste are added to the production process, foreign particles of various sizes and quantities are introduced into the melt flow. These have to be filtered out efficiently to ensure a consistent and high quality of the end product. At the same time, however, melt filtration must not have any disturbing influence on the production process*

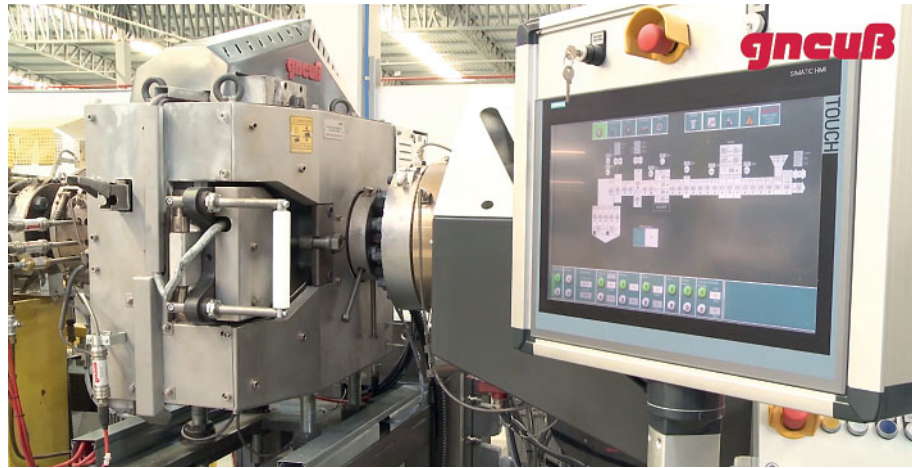

# Reliable, Trouble-Free Melt Filtration as a Decisive Factor for the Economical Use of Reclaim in Plastics Processing

Several filtration systems require a production interruption when changing screens, cause process disturbances due to pressure spikes or even generate particles if deposited material comes off during screen changes.

## **Disturbance-free production process thanks to permanently constant conditions**

In contrast, with the Gneuss Rotary Technology, the conditions in the melt flow are permanently constant, i.e. the pressure drop across the screen, respectively the amount of contamination on the screen, is kept constant, so that the line can always be operated in the optimum range.

This is achieved by the rotating movement of the filter disk, with which the screens are transported through the melt channel. A control system ensures that the screen contamination remains constant. As soon as the contamination load varies, the control system reacts automatically and changes the rotational speed of the filter disk. The pressure across the sys-

tem thus remains constant. The only non-constant variable in the filtration process is the rotational speed of the filter disk.

This makes the Rotary Technology the ideal solution for the increased use of reclaim or recycled material. Gneuss Melt Filtration Systems can be easily integrated into an existing process and are perfectly suited as a retrofit solution. The self-sufficient control system monitors the filtration process in conjunction with the production line.

## **Advantages of Gneuss Filtration Systems for recycling applications**

The Gneuss Filtration Systems have been developed for demanding recycling applications and have been used successfully for decades. All filters from Gneuss work with the proven Rotary Technology, which offers the following advantages:

- No interruption or disturbance of the production process caused by the filter operation
- Pressure-constant production, free from pressure spikes

- Automatic and safe operation with minimal operating effort
- Application-specific and rheologically optimised melt channel for short melt residence times, melt channel design free from dead spots and fast product changes
- Disturbance-free processing even of sensitive plastics
- Consistently high quality of the end product
- Simple and safe filter element replacement
- Efficient cleaning of the filter elements thanks to the fully automatic back-flushing Filtration System Type RSFgenius
- Screens made of multi-layer stainless steel mesh, which allows finenesses down to 10 µm in recycling applications
- For more than 35 years successful use in film, sheet and fiber production, compounding, PVC and other demanding applications

**Gneuss Kunststofftechnik GmbH**  
Mönichshausen 42, 32549 Bad Oeynhausen,  
Germany  
[www.gneuss.com](http://www.gneuss.com)



# IPTF 2021

IX International Polymer Technology Forum

May 25-26, 2021

Azimut hotel  
43/1, Lermontovsky prospect  
Saint-Petersburg  
Russia

Official language  
of the conference: Russian

240+  
participants

## Comprehensive review of all the vital technology issues for plastics processors

Extrusion  
Peripheral equipment  
Compounding  
Recycling  
Molds

Injection molding  
Polymers and additives  
Films  
Profiles  
Pipes and tubes



### Contacts

**Alla Kravets**  
+49 2233 949 87 93  
a.kravets@vm-verlag.com

**Bella Eidlin**  
+49 152 299 07 895  
b.eidlin@vm-verlag.com

**Olga Kirchner**  
+49 152 056 26 122  
o.kirchner@vm-verlag.com

**Martina Lerner**  
+49 62 26 97 15 15  
lerner-media@t-online.de

Learn more:



Organized by

**VM VERLAG GmbH**

**ЭКСТРУЗИЯ**

**ПЛАСТЕК**



[iptf.extrusion-info.com](http://iptf.extrusion-info.com)

# First Fully Recyclable Packaging Tube

*EPL Limited (formerly known as Essel Propack Limited), the world's largest specialty packaging company, has received global recognition from the Association of Plastic Recyclers (APR), USA for its Platina Tube with an HDPE closure. EPL's Platina is the first fully sustainable and completely recyclable tube in the world, including shoulder and cap, to get this recognition. It is the only tube to have an integrated shoulder 'Inner Barrier Liner' (IBL) that is also recyclable in HDPE recycle stream. This is a big step forward as it allows the total tube to be recycled in a single recycle stream*

APR maintains exacting standards for certification. Platina went through a rigorous test and qualification process for more than 3 months before the results were announced. Platina is an eco-friendly laminated tube produced with less than 5% barrier resin, and has earlier received recognition from the APR for consistently meeting or exceeding the most stringent APR HDPE Critical Guidance criteria.

After use, the Platina tubes and caps can be recycled in the dominant #2 plastic stream used across the globe



for recycling Milk Cans, Juice bottles etc. Use of HDPE in Platina and GML tubes increases the stiffness of the tubes, enabling EPL to reduce polymer content and in turn help users to deliver on their sustainability commitments.

The Platina range of HDPE tubes are designed to deliver source reduction and recyclability without the loss of any barrier properties. This allows for sustained product stability and durable shelf life of the packed content. Platina tube is especially suited for oral, toiletries, and food brands. Platina tubes and caps were also certified as 100% recyclable by RecyClass European certification for 'Code 2' (recycling) earlier, making them the only speciality packaging tubes and caps to be recognised as 100% recyclable, globally.

Sudhanshu Vats, MD & CEO EPL said: "Sustainability is a key area of focus for us and we constantly endeavour towards achieving it. We are extremely delighted to receive this recognition from APR, and this will motivate us to develop more innovative and sustainable solutions and consciously reduce our carbon footprint. This showcases our strong R&D capabilities, underlining EPL's global position as one of the world's leading innovative packaging manufacturers with the highest standards of sustainability, resource efficiency and recycling/reuse (PCR)".

Hariharan K. Nair, Vice President, Creativity and Innovation, said: "This is a big achievement for us at EPL. Sustainable solutions is a key focus area for us and we are striving towards achieving this objective across product lines. A first-in-the-world tag makes us proud and is a testament to our disciplined and creative work ethic. Recycling helps the environment even as it creates new economic opportunities, as recycled products can be made into new goods. Recycling helps still-useful materials prevent clogging up landfills and helps reduce fossil fuel consumption."

► The Association of Plastic Recyclers (APR)  
[plasticsrecycling.org](http://plasticsrecycling.org)

EPL Limited (formerly known as Essel Propack Ltd.)  
[www.eplglobal.com](http://www.eplglobal.com)

# EXTRUSION

EXPERT MAGAZINE ON PLASTICS EXTRUSION

The only technical magazine worldwide exclusively for the sectors:

- Material Preparation
- Compounding
- Extrusion
- Recycling
- Calendering
- Thermoforming
- Welding
- Finishing of Plastics and Elastomers



**Extrusion** (German)

**Extrusion International** (English)

**Extrusion International USA** (English)

**Extrusion Russia Edition** (Russian)

**Extrusion Asia Edition** (Mandarin/English)

The only plastics trade magazine for Asia, published from Germany

8 issues a year

6 issues a year

6 issues a year

4 issues a year

2 issues a year

**SMART  
EXTRUSION**

All editions available for free:  
[www.smart-extrusion.com](http://www.smart-extrusion.com)

**VVA** Verlag GmbH Cologne/Germany



*Picture 1: Comparing to film waste, it is more difficult to cut and feed raffia waste consistently into the recycling machine for its strength and size. Usually, it has to be done in separate steps*



# Raffia Producer Now Recycles in One Step

## Efficient recycling of PP raffia

Post-industrial recycling of PP raffia, woven sacks, tapes, non-woven/woven could be challenging at times for some producers due to the following reasons:

It's difficult to process in one single step due to size and strength of the material waste (ex. FIBC and jumbo bags).

When recycling has to be done in several processing steps, it is not cost-ef-

fective for the producers in terms of labor, electricity, and occupying too much factory space.

It's difficult to retain material property (strength and elasticity) after recycling in which the material degrades excessively and therefore, the reusability of the recycled pellets back into the production lines is relatively low.

And it is difficult to process heavily printed woven bags (for example

AD\*STAR bags) as the degassing and screw design of the recycling machine is not ideal for this type of material with extra amount of ink. (Picture 1)

## One-step, simple solution for raffia/woven recycling

Polystar's Repro-One recycling machine provides solutions to the above problems with the following features:



*Picture 2: One step process – Shredding + Extrusion + Pelletizing: Instead of having a separate off-line crusher or shredder, POLYSTAR's Repro-One integrates the shredder with the extruder, allowing a more automated and consistent feeding of the material, which results in stable output and higher quality of recycled pellets*

- One step process with shredder + extruder + pelletizer all integrated into one simple, easy to operate recycling machine. (Picture 2)
- Low processing temperature in the single shaft shredder: This gentle and short, one-step process ensures minimal material degradation, which allow producers to re-use a higher percentage of the recycled pellets back into the production lines and still meeting the industrial standards (for example, strength and elasticity of jumbo bags for US exports). (Picture 3)
- Specialized degassing and screw design for processing heavily printed bags: The optimal screw design can eliminate the problem of mate-

Picture 5: Heavily printed woven bags are usually more difficult to recycle and reuse in post-industrial applications



Picture 3: Instead of using an agglomerator or a cutter-compactor which processes the material at a higher temperature for a longer period of time, the gentle yet powerful single shaft shredder cuts the raffia waste within a short time at a much lower processing temperature. This helps to maintain the property of the post-industrial waste material as close to new material as possible



Picture 4: High efficiency degassing and specialized screw design can process heavily printed woven bags efficiently and obtain good quality pellets

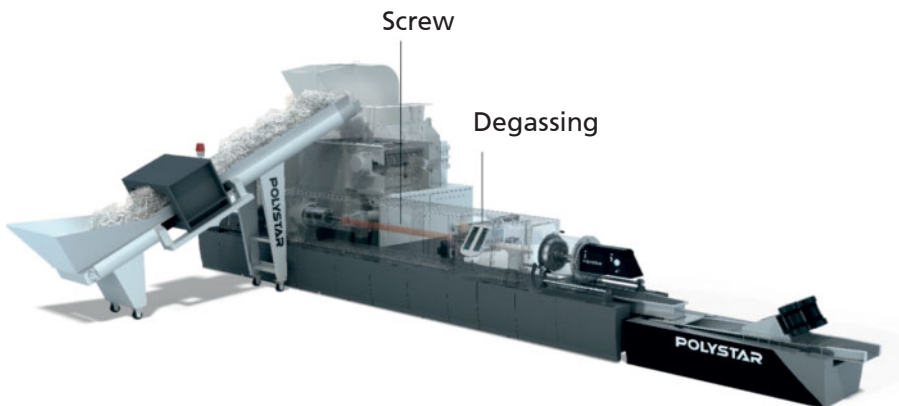

rial coming out from the degassing (venting) area almost completely, so the machine can operate at full speed with stable production. Efficient degassing is another key factor to en-

sure the pellets are solid (instead of fluffy and hollow in the middle). (Picture 4+5)

**Many advantages for raffia producers who recycle in-house**

In general, 8 % of production waste is generated during the process (from tape line production, looming and printing). The price of raw material is almost doubled comparing to the cost of having it recycled in-house. It would make sense for medium and large-sized raffia/woven producers (who generate more than 30~40 tones of scraps per month or more) to recycle the production waste internally to reduce production cost.

**62 raffia machines installed in India – 257 worldwide**

Many raffia and woven producers have already seen the benefits of doing in-house recycling using the Repro-One, including producers in Argentina, India, Indonesia, Mexico, Philippines, Saudi Arabia, Thailand, Turkey and many others.

Amongst the 62 installations in India, one of the Indian producers has already installed 4 sets of Repro-One at 4 different factory locations, since the first installation back in 2015. "It is cost saving and our operators find it very easy to run and maintain the machines," said Mr. Kumar, director of Kolkata-based jumbo bag producer, "the shredder integration is definitely the best choice for raffia and woven application," he added, explaining the reason why they decided to add the second, third and

## PP Raffia/Woven Recycling

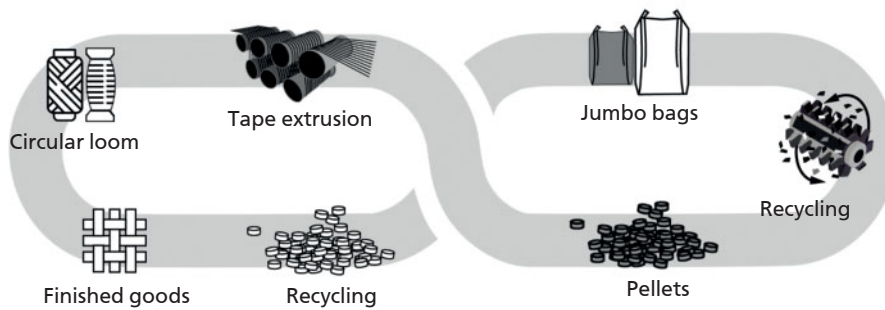

Picture 6: Solution 3: Plastic packaging in circular economy – Raffia and woven sector

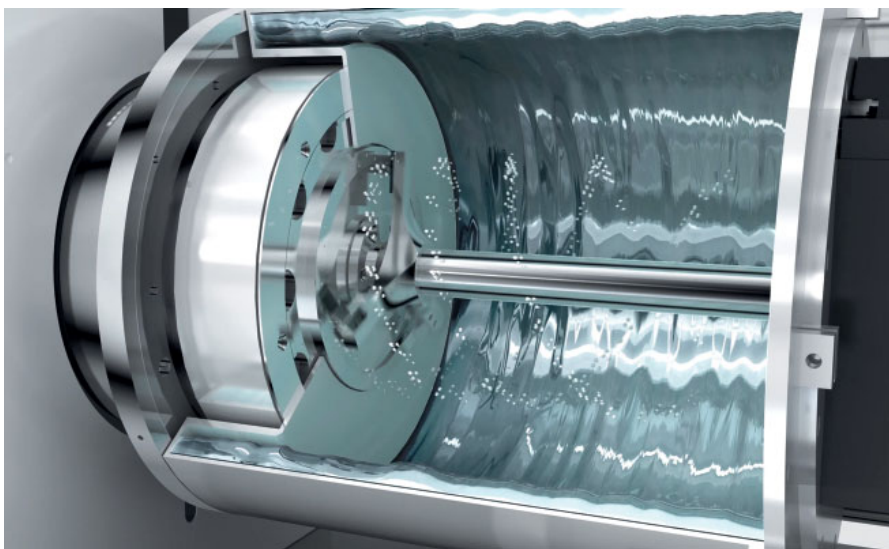

Picture 7: The pelletizing system of the Repro-One prevents PP pellets from sticking to one another, ensuring stable production and output without having to constantly stop the machine for adjustment

Picture 8: Raffia producer in Kenya has replaced three of its old recycling machines with a Repro-One, reducing electricity and labor costs while increasing the reusability of the recycled pellets



fourth machine in 2017, 2018 and 2020. “We produce all types of products with different sizes and shapes, including cement bags, sugar bags, fertilizer bags, mesh bags (for packing onion, ginger, garlic, potato), the machine can handle it all with ease.” “We also recommended the machine to our friends in the industry who produce mosquito and construction net, and they are very happy using the machine as well.”

The high quality pellets ensure easy reuse back again in the production process for raffia, non-woven, and Ad\*Star block bottom heavily printed bags. The reusability of the PP recycled pellets is particularly high with the Repro-One recycling machines, raffia producers can use between 20% to 100% recycled pellets back into the production line depending on the final product requirement.

### Simple-to-use, automatic pelletizing system for PP

The die face cutting design of the Repro-One is designed specifically to work with PP material:

- Automatic pelletizing speed adjustment – Prevents pellets sticking due to higher melting index of PP material. Produces more uniform-sized pellets without labor intervention.
- Automatic blade pressure adjustment – Allows the pressure between the pelletizing blades and the die head to remain constant. As a result there is less machine down time, easier and faster to change blades (Picture 7)

### Efficiency and reusability go up, cost goes down

In the case of a woven sack producer, who used to recycle using off-line shredders and agglomerators before feeding the material into the extruder. Ever since having installed the Repro-One 100, the producer has reduced the operation cost by 30 %. (Picture 8)



# SMART EXTRUSION

**THE SPECIALIZED WEBPORTAL  
ON EXTRUSION  
FOR EVERY MODERN NEED**



**VM** Verlag GmbH  
Cologne, Germany



[www.smart-extrusion.com](http://www.smart-extrusion.com)

# The 34<sup>th</sup> International Exhibition on Plastics and Rubber Industries

New Era. New Potential. Innovation for Sustainability

## 2021.4.13-16

Shenzhen World Exhibition & Convention Center, PR China

- 350,000 sqm Exhibition Area
- 3,600+ International Exhibitors
- 3,800+ Machine Exhibits
- 90,000 sqm Plastics & Rubber Raw Materials Zone

Pre-register for  
Admission Discount



[www.ChinaplasOnline.com](http://www.ChinaplasOnline.com)



Hong Kong (852) 2811 8897 | Singapore (65) 3157 3101

Chinaplas.PR@adsale.com.hk | [www.adsale.com.hk](http://www.adsale.com.hk) | (852) 9602 5262

ORGANIZER



CO-ORGANIZER



SPONSOR



OFFICIAL PUBLICATIONS & ONLINE MEDIA

