

03/2021

VVA VERLAG  
Cologne /Germany



# EXTRUSION INTERNATIONAL

USA

# 30 YEARS

CREATING  
THE FUTURE TOGETHER!



**500+**  
professionals  
in our team



**115 000+**  
productive  
capacity



**250+**  
brands  
of compounds

Increase in Turnover on the European Market. Page 24

polyplastic  
compounds 

We aim at discovering  
premium solutions  
for a better quality of life

## Profile stacking machine PRO



### Profile length measurement during extrusion

Using special sensors the length of individual profiles can be detected before the formation of a profile layer to stack. The measured length can be used for checking and correcting the cutting unit of the extrusion line or for documentation (quality assurance) of the produced profile lengths.

### Weight determination during extrusion

Special weighing units can be used to weigh individual profiles before forming a profile layer. The determined weight can be used to optimize the extrusion process.

### Stacking special profiles

STEIN Maschinenbau offers technical solutions for stacking heavy and large monoblock profiles.

Based on decades of experience, unusual profile geometries or special layer patterns can be evaluated by STEIN for their automated stacking.

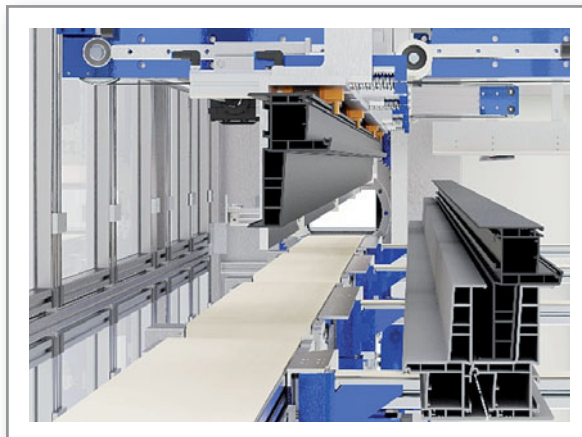
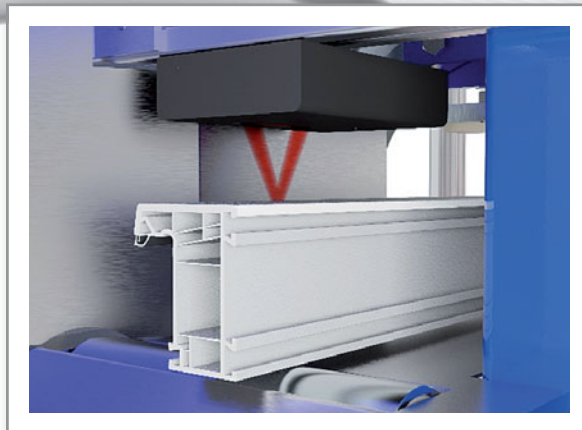

## Laminating foil cutting unit – turnable

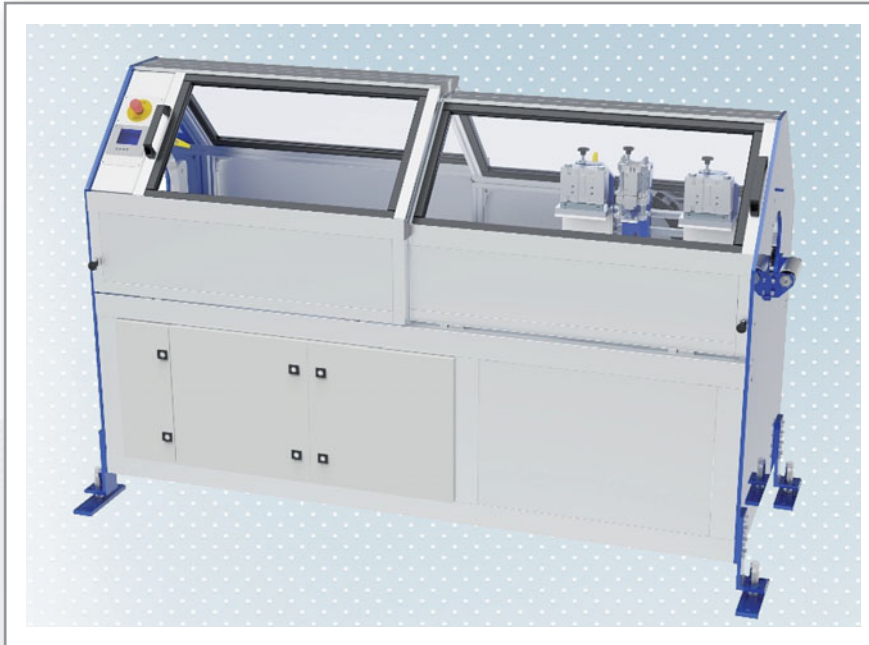

### Foil cutting for laminating lines

For the offline lamination of profiles single profile sections are provided to the laminating line **end to end** and are laminated with foil continuously.

After the lamination process the laminating foil has to be cut to separate the profiles again.

The **laminating foil cutting unit** detects the profile ends, makes a gap in between the ends and cuts the laminating foil automatically.

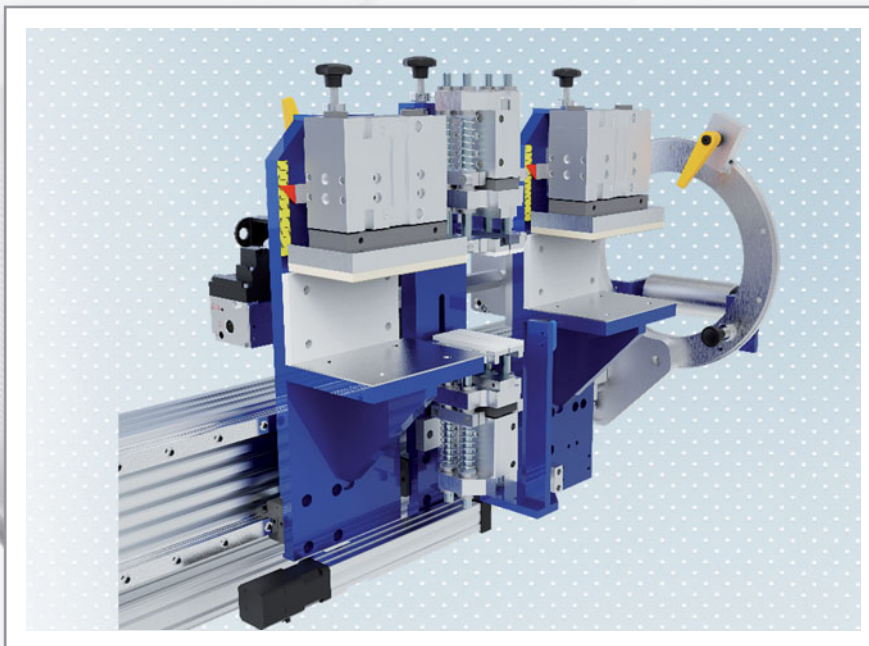

### Advantages of the laminating foil cutting unit

- No damage of the profiles when cutting the laminating foil.
- No interference of the cutting process into the laminating process.
- Turnable cutting unit for different film orientations.
- No danger to employees due to manual cutting.



**STEIN Maschinenbau  
GmbH & Co. KG**

Wartbachstr. 9

D-66999 Hinterweidenthal/Germany

Tel. +49/63 96/92 15-0

Fax +49/63 96/92 15-25

stein@stein-maschinenbau.de

www.stein-maschinenbau.de

**„STEIN BLUE-LINE – for a sustainable future“**  
stands for sustainable and energy-efficient equipment.

Almost 100% domestic production and the high degree of manufacturing penetration guarantee compliance with even the most stringent of demands.

Firms in this issue	6	Statement on Canadian Government's	
Imprint	7	„Toxic“ Label Released	27
<b>Industry News</b>	8	Automatically Hopper Device Enables to Accurately	
Calendar	8	Dosing	28
Wide Selection of Courses in English	8	Mourning The Loss Of One Of Their Own	28
COLOMBIAPLAST Re-Scheduled	8	New Flame Retardant Wire and Cable Jacketing	
K-MAG – 365 Days of Community News	9	Compounds Receive	
CHINAPLAS 2021 Concluded with a Huge Success	9	„Halogen-Free“ Assessments	29
First „AdEx Home“ Webinar	10	Tackifier Capacity Expansion in India Announced	29
Representation in Middle East and North Africa	11	<b>Compounding</b>	
New Date for ICE Europe	12	Increase in Turnover on the European Market	30
Italian Plastics and Rubber Processing Machinery		<b>Recycling – Case Study</b>	
Manufacturers – After the Drop in Revenues	12	PET Bottle to Bottle Recycling –	
in 2020 Orders Again Growing	13	Major Efficiency Improvements	
Business in Asia Expanded	13	by Retrofitting Melt Filtration System	31
Acquisition	13	<b>Recycling – Case Study</b>	
Acquisition	14	Cleaning Up Coasts at the Edge of the World	32
Digital Watermark Initiative		<b>Recycling</b>	
„HolyGrail 2.0“ joined	14	Reduced Odour – An Indispensable Quality	
New Machine Design has won		Criterion in Post-Consumer Plastics Recycling	34
the Good Design® Award	15	<b>Control Systems</b>	
New E-Book – The Circular Economy	15	Service Portfolio expanded – Control Solutions	
Bottle-to-Bottle Recycling Capacity doubled	16	for Complete Recycling Plants	36
New CEO	16	<b>Recycling</b>	
New CFO	17	The Best Recycled Pellets for Irrigation Pipes	37
Multi-Purpose Co-Extruders –		<b>Recycling, Circular Economy – From Research</b>	
Now also for Sheet Production	17	Today's Waste Becomes Tomorrow's	
Leaving the Board after more than 45 Years	18	Resource – „Waste4Future“ Paves	
Personnel Expansion for Sales Team	18	New Ways for Plastics Recycling	38
Management Board Expanded	19	<b>Recycling</b>	
New BOPE Additives for Agile and Efficient		2 Million Tons of Installed Recycling Capacity	
Response to New Market Trends	19	Worldwide Celebrated	40
Joint Venture in India Established	20	<b>Film Technology</b>	
Joining the Circular Plastics Alliance	20	Dual Frame System Boosts Efficiency	41
Next-Generation Space-Saving Scanning		<b>Pipe Extrusion</b>	
Measurement System for Narrow Web Processes	21	Strongly Positioned with Optimal Machine Technology	
Liaison Office in Turkey	21	for the Growth Market of PVC-O Pipes	42
Portfolio expanded	21	<b>Film Extrusion</b>	
New 500 Series Rubber/Silicone		Desire for Hygiene and Food Safety Increases	
Extrusion Crosshead	22	Worldwide Demand for Flexible Packaging Films	44
Capacity Expansion	22	<b>Measuring Technology – Case Study</b>	
New Vacuum Technology Optimises the Production of		Fast and Reproducible Sample Inspection	
High-Performance Oriented Films	23	of Plastic Pellets	46
Collaborative Project in Sweden intensified	23	<b>Pelletizing</b>	
<b>Industry News USA</b>	24	Melt Pump Technology	
Cooperation	24	for Production of Bioplastic PLA	48
LFT-D Line with 2,500-Tonne Press Ordered	24	<b>Extrusion Technologies</b>	
Material Tests on Shredder-Extruder Machines –		Extrusion Lines for Pipes Renewed	49
Service Offering for Customers in North America		<b>Pipe Extrusion</b>	
Expanded	25	Shape your Pipes, Shape your Future and Go Green	50
Director of International Sales for Extrusion Systems		<b>Extrusion Technologies</b>	
Promoted	25	Physical Foaming to In-House Extruder	
Next-Generation Case Packer with Collaborative		Test Line Added	51
Robot Automation System Launched	26	<b>Extrusion and Recycling Technology</b>	
Significant Additives Expansion in the U.S.	26	New Life for Worn Artificial Grass	52
Vice President of North America Operations Named	27	<b>Extrusion Blow Molding</b>	
Vice President and General Manager of Latin America		PCR in Cosmetic Packaging?	
Named	27	It's all a Question of Technology	56



**32** Lindner's new 1500 model from the Micromat series was presented at K 2019 in Düsseldorf, Germany. This very model was delivered to Chilean plastics recycler and circular economy pioneer Comberplast at the beginning of last year and has been successfully shredding old fishing nets and ropes collected from the Patagonian coasts for the past year



"We supply our customers with a plug & play solution immediately ready for use" is how Gernot Dorn, Director Sales PVC bei der battenfeld-cincinnati Austria GmbH, Vienna describes in a nutshell the decisive advantage of the machine manufacturer's cooperation with the Spanish company Molecor Tecnologia SL, based in Loeches-Madrid **42**



A sustainable society with climate-neutral processes requires significant adjustments in the value chains, which are only possible through innovations. Seven Fraunhofer Institutes are pooling their expertise in the lighthouse project "Waste4Future" to develop new solutions for this goal **38**



**40** In spring 2021 viscotec, a division of the Austrian machinery supplier Starlinger, reached a milestone: an impressive 2 million tons of capacity are available for the production of PET recyclate on viscotec systems worldwide

In March 2021, SORTCO opened a new, state-of-the-art sorting service center, where both optically demanding technical plastics and standard plastics are cleaned. The PURITY CONCEPT V from SIKORA, is used for final sample inspection after the sorting process **46**

The German manufacturer of Filtration Systems, Gneuss, has seen a surge of interest among customers looking to retrofit their extrusion lines **31**

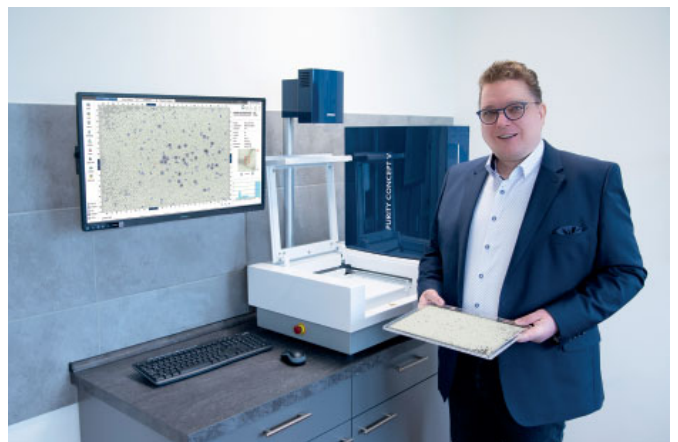

## Index of Advertisers, companies and *fairs* referred in this issue

AdEx Home 2021	10	Messe Düsseldorf	8, 9
Adsale	9	MOLECOR	42
AMAPLAST	12	motan-colortronic	7
Amcor	27	Movacolor	16
American Kuhne	25	Müller, W.	56
BASF	14	NDC	21
battenfeld-cincinnati	17, 42	Novosystems	13
Bausano	49	PLASTICS	27
Bekum	15	POLYPLASTIC	30, Outside Cover
BHS-Sonthofen	36	Poly Vinyl	24
Borealis	23	Proco Machinery	26
Brückner	44	PTI	28
CHINAPLAS	9	PURE LOOP	25, 37
Clariant	20	Reifenhäuser	14
COLOMBIAPLAST	8	Repi	13
Comberplast	32	Resilux	16
Davis-Standard	11, 24	Sesotec	15
Dieffenbacher	24	SI	22, 26, 29
EREMA	16, 34	Sica	50
Feddersen	21	Sikora	18, 46
FIMIC	11	SKYi	20
FKuR	20	SKZ	8
Fraunhofer-Institute IMWS	38	Smart-Extrusion	35, Inside Back Cover
Gneuss	31	SML	41
Graham Engineering	25	Starlinger	40
Guill	22	Stein Maschinenbau	Inside Front Cover+3
Hosokawa Alpine	23	Teknor Apex	29
ICE Europe	12	Tosaf	19
Kdesign	14	Troester	19
Kiefel	17	UBE	21
Lindner-Recyclingtech	32	Vecoplan	18
Maag	48	Vetaphone	13
Mack-Brooks	12	VM Verlag	Outside Back Cover
Maguire	28	Welex	25
MAS	52	XOL Automation	11
Meaf	51		



**Follow the news  
in the world  
of extrusion!**

Subscribe to digital magazines  
and Smart Extrusion weekly newsletter

- **Just** submit your **e-mail address**.
- Digital magazines and news updates **free of charge**
- No spam. Your data is safe



[www.extrusion-info.com/subscription](http://www.extrusion-info.com/subscription)



The Extrusion International Magazine is published bimonthly by VM Verlag GmbH. P.O.Box 501812, D- 50879 Cologne, Germany

**EDITORS**

Bettina Jopp-Witt (Editor-in-chief)  
Tel. +49 221 546 1539  
redaktion@vm-verlag.com

Dmitry Kosuch  
Tel. +7 996 730 0113  
d.kosuch@vm-verlag.com

**ADVERTISING SALES**

Martina Lerner  
Tel.+49 6226 971515  
lerner-media@t-online.de

Bella Eidlin  
Tel. +49 152 29907895  
b.eidlin@vm-verlag.com

Olga Kirchner  
Tel. +49 152 05626122  
o.kirchner@vm-verlag.com

**ADMINISTRATION**

Alla Kravets  
Tel. +49 2233 949 8793  
a.kravets@vm-verlag.com

**PRINTING**

maincontor GmbH  
Dr.-Gammert-Str. 13a, 63906 Erlenbach, Germany  
T.: +49 937294810811  
www.maincontor.de, info@frankhohmann.com

**SALES REPRESENTATIVES**

Quaini Pubblicita (Milano IT)  
Tel. +39 02 39216180  
info@quaini-pubblicita.it

China & Asia  
octavia@ringier.com.hk, Tel. +852-9648-2561  
maggieliu@ringiertrade.com, Tel. +86-13602785446

Tokyo PR Inc. (Japan)  
Tel. +81 (3) 3273-2731  
extrusion@tokyopr.co.jp

**Reprints, Translation etc**

No part of this publication may be reproduced, stored in a retrieval system, or transmitted, in any form or by any means, electronic, mechanical, photographic, recording or otherwise, without prior permission of the publisher.



[www.smart-extrusion.com](http://www.smart-extrusion.com)



## One of the most flexible hopper loaders on the market

 think materials management



### METRO G/F

Whether granules or flakes, the METRO G/F enables large conveying volumes and is also suitable for dusty material thanks to the implosion cleaning of the sieve filters.

motan-colortronic gmbh - [info@motan-colortronic.de](mailto:info@motan-colortronic.de)  
[www.motan-colortronic.com](http://www.motan-colortronic.com)



#### wire Russia, Tube Russia

08. - 10. 06. 2021  
Moscow, Russia  
[www.wire-russia.com](http://www.wire-russia.com),  
[www.Tube-russia.com](http://www.Tube-russia.com)

#### rosplast

15. - 17. 06. 2021  
Moscow, Russia  
[rosmould.ru.messefrankfurt.com/](http://rosmould.ru.messefrankfurt.com/)

#### Plastics & Rubber Vietnam

16. - 18. 06. 2021  
Ho Chi Minh City, Vietnam  
[www.k-globalgate.com/prv](http://www.k-globalgate.com/prv)

#### Innovations using Fluoropolymers

24. + 25. 06. 2021, Hybrid Event  
Würzburg, Germany  
[www.skz-bildung.de/123](http://www.skz-bildung.de/123)

#### Plastasia

02. - 05. 07. 2021  
Bangalore, India  
[www.plastasia.in](http://www.plastasia.in)

#### Equiplast

14. - 18. 09. 2021  
Barcelona, Spain  
[www.equiplast.com/en](http://www.equiplast.com/en)

#### interplas

28. - 30. 09. 2021  
Birmingham, United Kingdom  
[www.interplasuk.com](http://www.interplasuk.com)

#### Fakuma

12. - 16. 10. 2021  
Friedrichshafen, Germany  
[www.fakuma-messe.de](http://www.fakuma-messe.de)

#### Central Asia Plast World

11. - 13. 10. 2021  
Almaty, Kazakhstan  
[www.plastworld.kz](http://www.plastworld.kz)

## Wide Selection of Courses in English

■ The Plastics Center SKZ offers many services for the plastics industries and has been a reliable partner for 60 years to customers in Germany and abroad. Being known "as the address when it comes to plastic" and as the first responder for many companies within the plastic industry to whatever problem comes up along the value chain. One of the solutions for these obstacles along the production chain is often further education. In general, the key to high production quality is qualification.

Next to its regular course program SKZ has offered education courses in English for years usually after an inquiry from one of its international customers. Since there is a growing demand for training courses in English lately, online as well as on site, the institute now launched a catalog with training courses for plastics production and material science in English. "Our customer can count on high quality education in English or German. All our most demanded standard trainings are now also available in English," explains Matthias Ruff, head of sales.

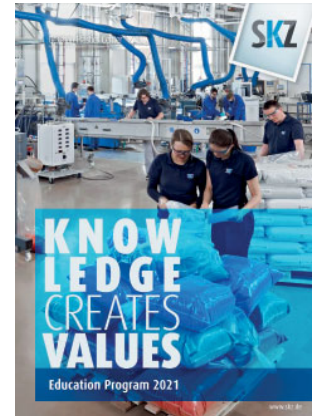

#### SKZ

[www.skz.de/fileadmin/user\\_upload/Download\\_PDF/Kataloge/SKZ-education-program-courses.pdf](http://www.skz.de/fileadmin/user_upload/Download_PDF/Kataloge/SKZ-education-program-courses.pdf)

## COLOMBIAPLAST Re-Scheduled

■ The next edition of COLOMBIAPLAST will take place from September 26 - 30, 2022, concurrently with the XXXIII BOGOTA INTERNATIONAL INDUSTRIAL FAIR (FIB), in Bogota, Colombia. COLOMBIAPLAST was originally scheduled for June 2021 but after talks with exhibitors and partners, the organizers decided to postpone the event due to the worldwide COVID-19 related effects. This measure is taken to ensure the safety of the exhibitors, visitors and staff. The goal is to organize a trade fair that meets everyone's expectations and provides a safe and comfortable environment to learn about trends and new developments, to do business and to strengthen contacts.

In December 2020, Acoplasticos, Messe Düsseldorf and Corferias signed an agreement for the joint organization of COLOMBIAPLAST 2022, with the purpose of strengthening its position as the leading trade fair for the plastics, rubber, petrochemical and packaging industries in the Latin American region. With this agreement, for the first time a trade fair from this region will become part of Messe Düsseldorf's "Global Gate" portfolio of plastics and rubber trade fairs and thus be supported by Messe Düsseldorf's extensive network of sales offices and subsidiaries in 141 countries.

#### Messe Düsseldorf GmbH

[www.eng.colombiaplast.org](http://www.eng.colombiaplast.org)



## K-MAG – 365 Days of Community News

*The new online magazine of K featuring facts, news, stories and trends from the international plastics and rubber industry*

■ For nearly 70 years K has been the World's No. 1 Trade Fair for Plastics and Rubber. However, K in Düsseldorf is not only the most relevant live event of the sector every three years but also views itself as the global communication platform for innovations and trends. This is why from now on there will be K-MAG, the new and permanent information and inspiration platform for the K community 365 days a year.

The new online magazine is aimed at all sectors associated with K and provides facts, news, stories and trends from the international plastics and rubber industry in German and English all year round. It will hone in on K's big themes such as sustainability, circular economy and digitalisation. It's all about the mix, which is why the K-Mag will include a wide range of features such as "Industry Voices" with forward-looking contributions by industry representatives and opinion leaders, "Science News" reporting about current research results and studies, or "Young Professionals" with articles and tips specifi-



cally for the young generation, while "Apropos K" addresses a plethora of plastics-related topics from everyday routine, history or from various countries.

To make the K-MAG as attractive as possible, the content will be presented in a variety of formats – such as editorial features, news, interviews, videos and photo galleries. The formats here range from clear fact and information processing to infotainment elements – always with a focus on plastics and rubber, of course.

■ Messe Düsseldorf GmbH  
www.k-online.de, mag.k-online.de

## CHINAPLAS 2021 Concluded with a Huge Success

■ CHINAPLAS 2021 was concluded on April 16 with a total of 152,134 visitors (149,771 local and 2,363 overseas). Despite the COVID-19 pandemic and the move to the new venue at Shenzhen World Exhibition & Convention Center, CHINAPLAS has once again proved itself to be a high standard plat-

form for presenting new technologies and sourcing latest products for the plastics and rubber industries.

Though the total number of visitors this year dropped by 6.85 %, the number of local visitors has increased by 23.46 % compared to the previous edition of show in Guangzhou in 2019. In addition, the Official Live Streaming platform has attracted 363,000 audiences and helped CHINAPLAS reach out to global buyers throughout the past four days.

With an exhibition area of over 350,000 sqm, CHINAPLAS 2021 hosted more than 3,600 leading exhibitors from all over the world, showcasing 3,800+ machines, raw materials, chemicals and other solutions.

Apart from countless exhibits and showcases, CHINAPLAS 2021 brought about a series of concurrent events under the theme of "New Era. New Potential. Innovation for Sustainability", supporting the plastics and rubber industries to grasp market opportunities and get ready for the challenges in the new era.

The next CHINAPLAS will take place in Shanghai, on April 25-28, 2022.

■ Adsale Exhibition Services Ltd. (Shenzhen) Ltd.  
www.ChinaplasOnline.com



## First "AdEx Home" Webinar

■ The premiere of the webinar "AdEx Home - Advanced Pipe Extrusion Technology" organised by VM Verlag took place on 14 April. Numerous interested participants followed the presentations held in English by Dr Jiri Vlcek (Compuplast), Timo Gebauer (SIGMASOFT) and Martina Bönig (Ingenieurbüro für Extrusionstechnik M. Bönig), who was also the moderator. Martina Bönig has been active in the extrusion industry for more than 25 years and currently works as an independent consultant and expert in all aspects of extrusion all over the world. At the beginning of the event, she emphasised the importance of computer simulation for the entire extrusion process, above all for saving money and time. This applies to all areas of plastics extrusion. And so the lectures revolved around precisely this topic: computer simulation.

The first lecture was given by Dr. Jiri Vlcek under the title "Simulation of the influence of stretching and material properties on the deformation of round products outside a die." The conclusion of his scientific presentation was that in the case of tube stretching, it could be shown that the dimensions of the product depended not only on the process conditions and shear viscosity, but also on the viscoelasticity of the material. In addition, with the help of the simulation, it can be shown



Martina Bönig



Timo Gebauer,  
SIGMASOFT



Dr. Jiri Vlcek,  
Compuplast

that a more strain hardening material tends to deform less in diameter. The results of the simulation can be used for an inverse approximation, according to Dr. Vlcek.

The second lecture, "Extrusion and simulation: How big is the step from the Excel file to the finite volume simulation?" was given by Timo Gebauer. He emphasised the great benefits of computer simulation, above all in terms of cost and time savings, under the premise: Prevent problems – Solve problems – Understand the process better.

The basic message of his presentation was that simulation does not have to be complicated. According to Gebauer, processors or toolmakers often shy away from tackling the topic of simulation because of the fear that they will have to hire a FEM specialist with a PhD who can perform this type of calculation. SIGMASOFT offers a product which, with pure process knowledge and some affinity for CAD programs, makes it possible to sample processes virtually and not to test them hour by hour in production. Real prototyping blocks expensive machines

and provides only a fraction of the information.

According to Gebauer, these times are coming to an end. If you want to remain competitive in the medium term, you have to deal with the topic of simulation. Gebauer: "We live in a time when development times are getting shorter and shorter and mistakes are no longer forgiven. At the same time, demands on tolerances and the complexity of processes are growing. Simple estimates and design from the gut will continue to decline, especially in view of the increasing shortage of skilled workers. I think the benefits of simulation on slide 12 speak for themselves."

Finally, the moderator Martina Bönig herself gave her presentation "Requirements and possibilities for sustainable process optimisation – analysis, implementation & economic efficiency."

She questioned the concept of process optimisation. This means finding and eliminating the actual cause of a process problem, not fighting the problem, and described which requirements are necessary for sustainable process optimisation and which possibilities are generally available at present.

The organiser, VM Verlag GmbH, would like to pursue this forward-looking topic of simulation further and offer a follow-up event in due course.

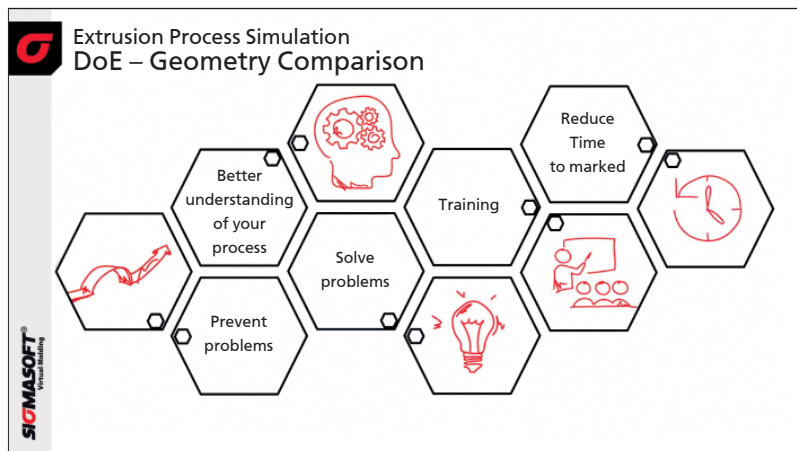
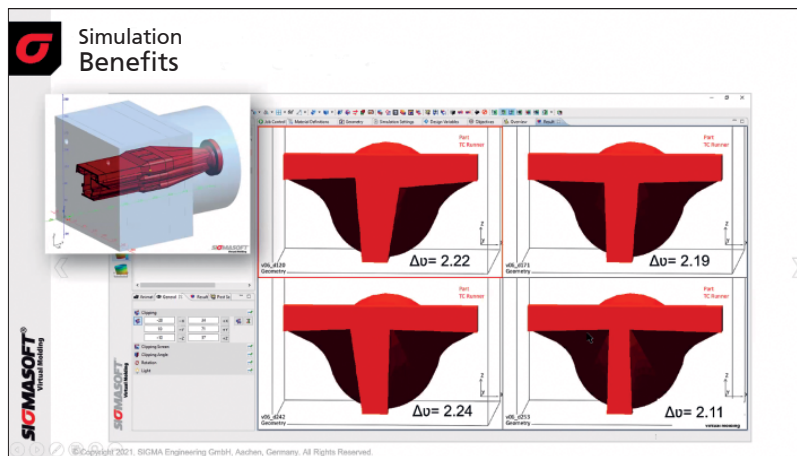

## Representation in Middle East and North Africa

■ Davis-Standard’s German subsidiary, ER-WE-PA GmbH, announced that XOL Automation will be Davis-Standard’s registered sales representative for extrusion coating, liquid coating, cast film and slitter/rewinders in the Middle East and North Africa. The agreement was made official in February. The area of XOL’s representation includes Saudi Arabia, UAE, Oman, Bahrain, Kuwait, Qatar, Lebanon, Jordan, Egypt, Morocco, Algeria and Tunisia. This will further expand the reach of Davis-Standard’s converting equipment range and services to support customers worldwide.

“XOL Automation has an excellent reputation in serving the industrial and manufacturing segment throughout this region,” said Adnan Bdour, Davis-Standard’s Regional Sales Manager. “Whether customers are looking to upgrade machines or purchase new technology, we are pleased to have them represent us. We also appreciate their knowledge of engineering practices and commitment to helping our customers improve productivity and profitability.”

“We are very excited to work with Davis Standard. XOL Automation team is known for its expertise in the flexible packaging industry. We have been using our recognized experience in this area with customers for years,” said Gabriel Hage, General Man-



XOL Automation home office

ager of XOL Automation. “Teaming up with Davis-Standard will provide our valued clients with cutting edge solutions and continued support” added Hage.

■ Davis-Standard, LLC  
[www.davis-standard.com](http://www.davis-standard.com)

XOL Automation  
[www.xolautomation.com](http://www.xolautomation.com)

# FIMIC®

ITALIAN MELT FILTER

**METALLIC MESH SCREEN**  
from 80 to 2.000 micron

**LASER SCREEN**  
from 80 to 300 micron

**PUNCHED SCREEN**  
from 400 to 2.000 micron

## PICK YOUR FIMIC'S SLICE

[www.fimic.it](http://www.fimic.it)

## New Date for ICE Europe



■ Following the recent communication on the shows' postponement, Mack-Brooks Exhibitions announced the new dates for ICE Europe, CCE International and InPrint Munich. The collective of converting, paper and print exhibitions was scheduled for 22 to 24 June 2021 and will now take place from 15 to 17 March 2022 at the Munich Trade Fair Centre in Germany.

"Following our decision to postpone ICE Europe, CCE International and InPrint Munich, we are pleased to be able to offer our usual event slot in March. This hopefully ensures that

the live events can continue their critical role in bringing the global converting, paper and print industry together again. In the meantime, we will offer opportunities to exchange knowledge, network and conduct business in a safe online format with further details on digital offerings to be released in due course", explained Patrick Herman, Event Director of the Converting, Paper and Print Events at Mack-Brooks Exhibitions. ICE Europe, the International Exhibition for Paper, Film & Foil Converting, is the world's leading exhibition for the conversion of flexible, web-based materials, such as paper, film, foil and nonwovens.

■ Mack-Brooks Exhibitions Ltd  
[www.ice-x.com/europe](http://www.ice-x.com/europe)

## Italian Plastics and Rubber Processing Machinery Manufacturers – After the Drop in Revenues in 2020 Orders Again Growing

■ After the record peak in 2017, substantially continuing into 2018, then followed by a cyclical set back in 2019, last year revenues for Italian plastics and rubber equipment manufacturers recorded a drop of 11.4% to a total value of 3.9 billion euros.

According to data from the MECS-AMAPLAST (national trade association and member of Confindustria) Statistical Studies Centre, which were analysed accounting for ISTAT data, the result was caused by a contraction in the domestic market (-12.5%) to 1.96 billion euro and by a drop in sales on foreign markets (-11.2%) to 2.72 billion euros. A final factor was a 14.3% reduction in imports to 780 million euros.

An examination of the geography of exports in 2020 reveals a rise in sales in Europe, which represents 58.3% of the total (with good performance particularly in extra-EU markets), while Asia (falling to 16.7% from 17.5% in 2019) and North America (to 14.6% from 15.2%) lost some ground. Many of the top 10 export countries recorded double-digit drops, significant exceptions being +42% to Russia and +14% to Turkey.

Analysing exports by goods category, the industry has recorded significant and widespread slumps in sales of almost all technologies, the only exceptions being plants for mono- and multi-filament and thermoforming machines, used to produce trays, cups, and other food packaging, which have witnessed rising demand as a result of new consumption patterns induced by the pandemic.

The expectations for a positive inversion of trend in 2020 after the downturn in 2019 were dashed by the Covid-19 emergency, which required the implementation of extraordinary containment measures – involving shutdowns of numerous production segments that were considered non-essential, including the plastics and rubber processing machinery industry, as well as travel restrictions – which effectively blocked operations for a number of weeks. In parallel, the progressive spread of the epidemic in various countries generated a high level of spread of the epidemic in various countries generated

a high level of uncertainty as regards the international macro-economic outlook.

The main impact on the system was especially strong between the first and second quarter, followed by a recovery that accelerated in the last quarter, mitigating the overall negative result.

It also bears emphasizing that AMAPLAST members fared relatively well with respect to the overall sector. A comparison with 2019 reveals a drop in their revenues of 2.8%, which is quite minor considering the global context. As regards employment, on the other hand, we may actually speak of gains, with an impressive increase of 3.3%.

Overall, the year 2021 began in an encouraging manner: a rebound in production and exports is foreseen, although it might be overly optimistic to expect a return to pre-crisis levels within the space of a few months. This will be much more likely to occur in 2022.

Confirmation of the Transition 4.0 Plan, i.e. governmental incentives to replace machinery and equipment, will pump needed fuel into the domestic market, the one hardest hit in the past months. Significant recoveries in progress in certain key markets, such as China and the United States, will boost exports for the sector.

However, overall forecasts remain cautious because there is still strong uncertainty in many markets, influenced by the prolonged pandemic, the slow pace of vaccination campaigns, and the difficult process of resuming travel, especially internationally. Not to mention that price increases have accelerated in the recent period for polymers, other raw materials, components, and maritime shipping costs.

In any case, affirming a counter trend with respect to 2020, half of the member companies that took part in a recent AMAPLAST survey reported growth in orders in the first half of 2021 with respect to the second half of 2020, albeit to varying degrees.

■ AMAPLAST  
[www.amaplast.org](http://www.amaplast.org)

## Business in Asia Expanded

■ In a move that confirms its commitment to strengthening sales and service coverage in south east Asia, leading corona treatment manufacture, Vetaphone, has made a raft of new appointments in the region. The new agents will cover Thailand, Vietnam, Malaysia, and Indonesia, and provide full sales and service support to existing and new customers in their respective regions.

Speaking as the Vetaphone Area Sales Manager for Asia, Holger Selenka said: "I know from many years' experience of working in the region that it has special requirements that must be addressed by people with the right expertise and understanding of the local market. I'm confident that these new appointments will make a significant difference to our business in what is a fast-developing region with exciting prospects."

FPT Engineering Company is the new name for Vetaphone sales and service in Thailand. A subsidiary of SV Machinery, which has been manufacturing flexible packaging products for more than 40 years, the company is run by Sales Manager Natdanai lamudomlap (aka Art) and Engineering Manager Wasaphol lamudomlap in a team of four whose qualifications include degrees in accounting, marketing, engineering and chemistry.

In Vietnam, Nguyen Anh Tu (aka Max) heads up the Plastic & Converting Division of Song Song Co Ltd in Ho Chi Minh City.

*Natdanai & Wasaphol lamudomlap of FPT will represent Vetaphone in Thailand*



*Rayson Ng of Colorblend represents Vetaphone in Malaysia*



*Nguyen Anh Tu heads up Song Song which handles Vetaphone business in Vietnam*

The company represents a range of top-end manufacturers supplying the flexible packaging industry in both wide and narrow web formats from extrusion through to converting and processes in between, setting itself up as a 'one-stop-shop' for the Vietnamese market.

Puchong Selangor, near the country's capital Kuala Lumpur is the headquarters of Colorblend, the new representative in Malaysia. Rayson Ng runs a business whose portfolio of technology includes numerous leading brands from the West in the extruding, printing and converting sectors, which he claims adds significant value to downstream processing in the highly competitive and fast-growing food packaging sector of the market.

The fourth appointment, in Indonesia, is Merindo Makmur. Based in Jakarta, and with branch offices in Surabaya, Medan, and Semarang, the company, which was established in 1997, is led by Tedy Lim and serves a variety of industries from plastics, printing and packaging to woodworking and pharmaceuticals. With an established portfolio of leading international machinery manufacturers, Merindo Makmur is an ideal fit for supplying sales and service support for Vetaphone's surface treatment technology as the industry moves towards 4.0, and all that it brings.

► Vetaphone  
www.vetaphone.com

## Acquisition

■ REPI has acquired Novosystems GmbH, one of the few independent European players in the field of liquid colours and additives for thermoplastic materials. With the acquisition of the German-based company, REPI will strengthen its position in one of the key polyurethanes and plastics markets in the world, as well as improving the Group's geographical footprint in Central and Northern Europe, with the aim of providing better and faster response to the market. Novosystems will also contribute with complementary technology platforms, which can be leveraged by REPI's global presence, and will accelerate value creation through superior level of expertise in liquid formulation and dispersion technologies.

"Welcoming a private, family-owned company in our Group is another exciting milestone for REPI, as both companies shared a common history in liquid colourants for plastics, and we are looking forward to shape our future together based on common values and a long-term vision and strategy. Germany has long been one of the most important markets for REPI, and this investment strengthens our commitment to a country served by REPI for over 40 years", comments Filippo Angiolini, REPI Group CEO.

► REPI Gruppe  
www.repi.com

Novosystems GmbH  
www.novosystems.de

## Acquisition

■ As of April 2021, the machine and plant manufacturer Reifenhäuser has acquired a majority stake in Kdesign GmbH, a global leader in the manufacture of air cooling rings and measuring systems for blown film extrusion lines. With this purchase Reifenhäuser Group, a specialist in extrusion technologies, expands its in-house expertise in cooling, controlling, measuring and calibrating blown films and will give its customers in this segment an even clearer competitive edge in the future.

Kdesign remains an independent company within the Reifenhäuser Group and its business and customer relationships will continue unchanged. Joachim Lange and Richard Zimmermann continue to head the company as managing directors.

Reifenhäuser CEO Bernd Reifenhäuser looks forward to the value opportunities for both companies and the customer benefits resulting from the close association of the two specialists: „In the blown film production process, cooling and controlling have a decisive impact on the quality of the end product. Our colleagues at Kdesign already offer the best technology on the market for this, which we are now bringing together with our extrusion technology. Customers will benefit from the ideal pairing of cooling expertise and specialist knowledge in hot parts. From now on, we can perfectly harmonize our products for optimum performance and together we can develop technologies more quickly.“

Current Kdesign customers will also benefit. As a member of the Reifenhäuser Group, Kdesign now has access to a large international service network and the world's largest



*From left: Bernd Reifenhäuser (CEO, Reifenhäuser Group), Richard Zimmermann (Shareholder and Managing Director, Kdesign), Gerd Fähling (Shareholder and head of sales, Kdesign), Joachim Lange (Shareholder and Managing Director, Kdesign), Ulrich Reifenhäuser (CSO, Reifenhäuser Group) (Photo credit: Reifenhäuser)*

privately run research and development centre for plastics extrusion. Richard Zimmermann, managing director of Kdesign, says: „We will be able to be closer to our customers in the future and have better development opportunities. Our location is just 20 minutes away from Reifenhäuser's headquarters. We are looking forward to working together and having a close personal exchange.“

■ Reifenhäuser Group  
www.reifenhauer.com

Kdesign Group  
kdesign-web.de

## Digital Watermark Initiative "HolyGrail 2.0" joined

■ BASF has joined "HolyGrail 2.0 – Digital watermarks for accurate sorting and high-quality recycling" as a member. The initiative aims to increase plastic recycling rates by adding imperceptible digital watermarks to product packaging.

Under the auspices of AIM, the European Brands Association, BASF and more than 120 companies and organizations from the packaging value chain have joined forces in the initiative to prove the viability of digital watermarking technologies for accurate sorting and the business case at large scale.

Ineffective sorting is one of the fundamental barriers to wider recycling of lightweight packaging waste and thus in achieving a circular economy for packaging. The better the sorting and identification of packaging, the more efficient the mechanical recycling process and the better the quality of recyclates.

The discovery of digital watermarking was made under the New Plastics Economy program of the Ellen MacArthur Foundation, which investigated different innovations to improve post-consumer recycling. Digital watermarks were found to be the most promising technology. The "HolyGrail 2.0" initiative will include the launch of an industrial pilot to prove the viability of digital watermark technologies for more accurate sorting of packaging and higher-quality recycling, as well as the business case at large scale.

Digital watermarks are imperceptible codes, the size of a postage stamp, covering the surface of a consumer goods packaging. They can carry a wide range of attributes such as manufacturer, type of plastics used etc.

■ BASF SE  
www.basf.com

# New Machine Design has won the Good Design® Award

■ “This award is a special honor and symbolic of the positive change at Bekum,” proudly notes Michael Mehnert, Managing Director.

The credo of the family-owned company has been uncompromising quality for over 60 years to this day. While functionality, durability and tradition have always been the focus, design has played a lesser role until now.

With the start of Michael Mehnert, son of the company founder, in 2016, Bekum entered a new, more modern era. His mission is to combine innovative technologies and forward thinking ideas with the company’s tradition and to make the generational change and the dawn of a new era visible in all areas of the company through a new corporate identity. The beginning of this journey was marked by the new corporate and machine design, without affecting the well-known qual-

ity and brand recognition. Many new user-friendly features as well as performance-enhancing technological and energy-efficient refinements were developed for a new generation of machines and presented for the first time at the K 2019 trade fair in Düsseldorf in the “CUT” machine design.

“CUT” stands for aesthetics, modern color and shape design. The new design is characterized by aesthetics, modern color and shape as well as even more functionality and improved ergonomics. With intelligently beveled surfaces in combination with large, lightly tinted viewing panels, it underscores the distinctive innovative capability of Bekum blow moulders. The streamlined design style at the detail level enhances the visibility of the machine’s high quality. The large yellow color insert clearly indicates a Bekum blow moulder and ensures the distinct high brand recognition.

In line with the award-winning machine design, Bekum also decided to completely overhaul the machine control and user interface design. The user-friendliness of the Bekum Control 8.0 with a 24” touchscreen has been improved by reducing the number of switching elements on the control panel and graphically redesigning the user interface. The machine handling has also been simplified by means of intuitive menu navigation.

“The new machine design conveys our goal of being the benchmark in blow moulding technology,” concludes Michael Mehnert.

*Newly designed Concept 808 electric blow molding machine honored with the Good Design Award 2020 (Image sources: Bekum)*

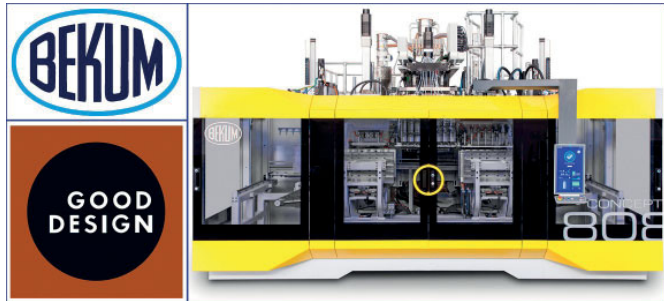

■ Bekum Maschinenfabriken GmbH  
[www.bekum.com](http://www.bekum.com)

## New E-Book – The Circular Economy

■ Sesotec recently published a comprehensive e-book on the topic of “Circular Economy” on its website. In it, recyclers as well as manufacturers and processors of plastics will find insights into the most important factors of the Circular Economy. In particular, the goal of creating a circular econ-

omy, which must be profitable not only for people and the environment but also for recyclers, manufacturers and processors of plastics, comes under consideration.

The plastics industry is under pressure. Between climate change, excessive consumption of finite resources, and vast amounts of plastic waste in the world’s oceans, plastics are coming to be seen in a different light by politicians, businesses, and consumers alike. The urgency is becoming increasingly apparent: it is time to rethink plastics on a global scale. Such an overhaul must include legislation, the development of new kinds of plastic packaging, and innovative recycling technologies and concepts.

The e-book is available for free download at the link:

*(Image: Sesotec GmbH)*



■ [www.sesotec.com/emea/en/resources/blog/new-e-book-the-circular-economy](http://www.sesotec.com/emea/en/resources/blog/new-e-book-the-circular-economy)  
 Sesotec GmbH

## Bottle-to-Bottle Recycling Capacity doubled

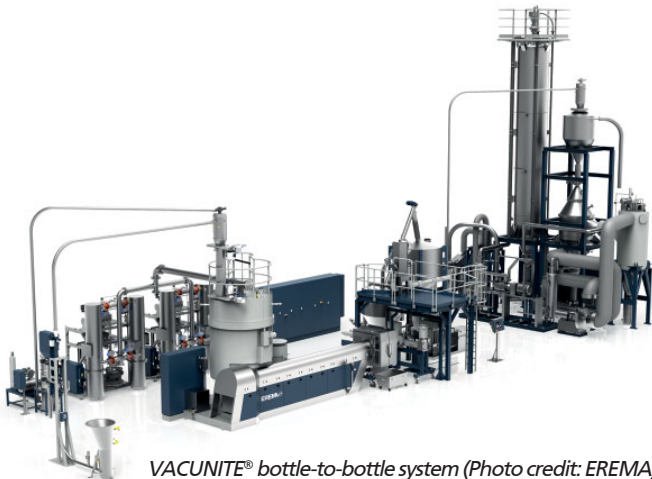

VACUNITE® bottle-to-bottle system (Photo credit: EREMA)

■ Resilux, a leading PET bottle and preform producer, has announced a major new technology investment which will result in them doubling their bottle-to-bottle PET recycling capacity. Using state of the art equipment from Erema, it is Resilux's latest step in their drive to create a truly circular economy in PET.

The new VACUNITE® bottle-to-bottle system enables Resilux to significantly ramp up their production of food grade recycled PET. The new investment has been made in response to increased customer demand and the expectation that production will only increase in the future. Marcel van de Sande, Resilux Group Chief Operating Officer, says: "The new technology puts us in the perfect position to ride the next green wave by using the 'Power of PET'".

The equipment is to be installed at the company's Bilten location in Switzerland where the Resilux Group Recycling competence centre is based. The investment reinforces Resilux's commitment to making a complete sustainability loop by creating solutions that are best not only for the products they package, but also for the wellbeing of people and the planet. For them it is another demonstration of being 'safe for the planet' – and its ability to be both a versatile and sustainable packaging solution.

■ Resilux  
www.resilux.com

EREMA Engineering Recycling Maschinen und Anlagen GmbH  
www.erima.com

## New CEO

■ A leadership change has taken place within Movacolor. Gerhard Dersjant, former CEO Movacolor: "After 13 beautiful years as CEO, I have decided to take a step back. It is time for someone else to lead Movacolor into its next stage. I am happy to inform you that Marc Aandeweg has started as the new CEO of Movacolor as of April 1st."

Gerhard Dersjant continues: "Marc Aandeweg has a proven track record as an international marketing and sales leader at various technical companies operating worldwide. In the course of his career he has gained experience in international key account management, product management, corporate marketing & communication and go-to-market strategies for high-tech product portfolios. His know-how and expertise will help Movacolor to continue its growth and development. Having spent time with Marc over the past 4 months, I am confident that Marc is the right person for Movacolor and he will have my full support through the transition"

Marc Aandeweg adds: "I am thrilled to join the Movacolor family after 13 years of leadership from Gerhard. I would like to thank him for his major contributions and for laying the foundation for Movacolor as it is today – a global leader in the dosing world. I look forward to working with you and all



Marc Aandewegen and Gerhard Dersjant

the talented people here at Movacolor as together we guide Movacolor into the future".

Gerhard Dersjant will support Marc Aandeweg through this transition in the Movacolor business. In his future role, Gerhard will remain involved with Movacolor and will become a member of the Movacolor Supervisory Board.

■ Movacolor  
www.movacolor.com



## New CFO

■ Richard Schmidhofer has been Commercial Managing Director of KIEFEL since February 1, 2021 and succeeds Peter Eisl, who left the company at his own request.

As CFO, Richard Schmidhofer takes on management of the Finance, IT and Purchasing departments. With Schmidhofer, Kiefel gains an experienced management executive: He not only brings in extensive knowledge from his previous positions as managing director, but has also successfully accompanied and decisively shaped industrial companies of various sizes and orientations.

“We are delighted to have gained such an experienced commercial managing director in Mr. Schmidhofer,” said Thomas Halletz, CEO of KIEFEL GmbH.

The managing directors – Thomas Halletz, Stefan Moll (CTO) and Richard Schmidhofer – will now align the company even more closely to future strategic issues.

*Richard Schmidhofer is the new CFO at Kiefel (© KIEFEL GmbH)*



■ KIEFEL GmbH  
www.kiefel.com

## Multi-Purpose Co-Extruders – Now also for Sheet Production

■ The successful, standardized and powerful uniEX single screw extruder series from battenfeld-cincinnati Germany is now also available for sheet and board extrusion. High-lights of this extruder series are compact design, a wide processing window and high throughputs with gentle melt treatment. This makes these machines ideal co-extruder models.

Regardless of whether a sheet manufacturer wants to make special multilayer sheet, mono-material sheet with a slightly modified covering layer or ecological alternatives with a middle layer consisting of regrind, co-extruders are always needed. Here, uniEX extruders allow extremely space-saving concepts, since thanks to their U design they can be installed much more compactly than previous models. This not only

ensures a smaller overall footprint of the line, but also shorter melt channels, which in turn has a positive effect on purging time and material consumption.

Since its market launch, the uniEX series has established itself very successfully in the market. Following the extension of its process engineering options, it is now also available for sheet and board extrusion lines in three sizes (35, 45 and 60 mm), and thus replaces all older series. The output rates range from 50 to 500 kg/h, depending on the material. The pronounced modularity of the extruders enables them to perform virtually any type of special processing task. A wide range of different plasticizing units is available to cover every application. These come with a choice of either grooved or smooth feed zones. Fitting the extruders with a degassing unit, as is required for ABS processing, presents no problem either.

Moreover, a great variety of different mechanical engineering options are available, such as screw extraction to the rear, a gearless drive via torque motor or flexible positioning of the control cabinet. Extensive standardization in production ensures high and above all fast availability of parts and consequently short delivery times and quick troubleshooting in case of problems.

The models of the uniEX series stand out by their extremely wide process and application window and their ability to process a great variety of different materials thanks to specific screw geometries.



■ battenfeld-cincinnati Germany GmbH  
www.battenfeld-cincinnati.com

## Leaving the Board after more than 45 Years

■ As announced by the Supervisory Board of SIKORA, Harry Prunk left the SIKORA Board on March 31, 2021 after more than 45 years of very successful work. He has shaped the development of the company and contributed significantly to the success of the brand.

Harry Prunk started his career at SIKORA in 1975 directly after finishing his studies in electronics as the third employee with the company founder Harald Sikora. 11 years later he was appointed Managing Director of SIKORA Industrieelektronik GmbH. In 1981, he founded the first subsidiary for SIKORA, SIKORA International Corp. in California, USA. Since 1996 he has been a shareholder of the company SIKORA

Since the transformation of the company into SIKORA AG in 2002, Harry Prunk has been a Member of the Management Board, which he chaired from 2011 to 2015.

"We thank Harry Prunk for more than four decades full of outstanding achievements for our company, for the close cooperation with customers in the wire and cable, hose and tube as well as plastics industry and for his persistent commitment in building up the SIKORA subsidiaries and representatives", says Prof. Dr. Thomas Sikora, chairman of the Supervisory Board of SIKORA AG. "The many years of wonderful and trustful cooperation will remain unforgettable."

Dr. Christian Frank, CEO at SIKORA, appreciates his special commitment: "Harry Prunk understands and embodies SIKORA like hardly anyone else. With him, the company developed many new regions and inspired numerous customers. In the cable industry there is probably nobody who does not know Harry Prunk. I would like to thank him for his pas-



Harry Prunk

sionate commitment, his untiring support of our employees, his valued advice and especially for his valuable friendship." Since March 1, 2020, Dr. Jörg Wissdorf has been the new Member of the SIKORA Board and officially takes over the succession and responsibilities of Harry Prunk as of April 1, 2021. The graduated Aerospace Engineer previously worked in various leading positions in Sales and Marketing as well as Managing Director at national and international companies. Harry Prunk will remain professionally active after his retirement as SIKORA Board Member and will realize new, challenging projects as Consultant for Corporate Development with a focus on management and internationalization.

■ SIKORA AG  
www.sikora.net

## Personnel Expansion for Sales Team

■ Vecoplan AG continues to grow with innovations and new products. The English subsidiary Vecoplan Limited has welcomed two new members to its team. This will enable the

*In his new role as International Area Sales Manager, Ruben Maistry will serve customers and agents in the international market*



*Gareth Bray is now a new member of the UK Vecoplan sales team (Photo credits: Vecoplan)*



company to provide even more comprehensive support for its customers. As the International Area Sales Manager for the Recycling/Waste Division, Ruben Maistry will draw upon his extensive and in-depth knowledge of the recycling industry to support customers and agents all over the world. Vecoplan customers will benefit from his 12+ years of experience in the metal and waste recycling industry and his extensive knowledge of plant engineering.

Gareth Bray is also new to the Recycling | Waste Division. At Vecoplan Limited, he will serve customers throughout the UK market in his role as Area Sales Manager, focusing on the material and energy recycling of waste and plastics, data and file destruction, and the consistent expansion of the Waste-2-Energy sector. He can look back on around 25 years of experience in recycling.

■ Vecoplan AG  
www.vecoplan.com

## Management Board Expanded

■ TROESTER announced that Thomas Holzer joined the Management Board of the Hanover-based company on March 1st, 2021. In addition to the Managing Partner and CEO Dr. Peter Schmidt and COO Bernd Pielsticker, Thomas Holzer will be responsible for Engineering and Sales.

*The new TROESTER Management Board (from left to right): Thomas Holzer, Dr. Peter Schmidt (Managing Partner) and Bernd Pielsticker*



Three people sharing the management responsibility is intended to strengthen sustainability and the knowledge base in the company, while creating new energy for organic growth and innovation.

After studying Process Engineering, Thomas Holzer started his career in the paper division of the technology company Voith. He held management positions at the company in Germany, Indonesia, Austria, and China, where he was responsible for global projects as well as the service and spare parts business for many years. Holzer has comprehensive knowledge in the sale, engineering and project management of special machines, and brings with him a wealth of management and leadership experience. He sees himself as a team player: "I am looking forward to my role at TROESTER. As part of a strong team, I would like to generate fresh impetus for the further development of TROESTER's business areas. I bring with me my international experience to successfully position the company globally in the future. We are living in a time of great challenges that we are tackling with all our strength and for which we are finding sophisticated solutions."

■ TROESTER GmbH & Co. KG  
www.troester.de

## New BOPE Additives for Agile and Efficient Response to New Market Trends

■ A current trend in the production of films for disposable packaging is moving from multilayer to mono-material concepts that are easier to recycle and have better mechanical and optical properties. Here, biaxially oriented polyethylene-based films (BOPE films) enable high-performance solutions that can be superior to conventional BOPP packaging films in terms of processing and cost efficiency. Tosaf has developed new additive masterbatches specifically tailored to the PE film orientation process. Currently, this portfolio includes slip, anti-block, antistatic and antifog additives. The ability to use them individually or in combination gives manufacturers high flexibility in meeting specific product requirements.

Tosaf has worked closely with Brückner Maschinenbau to validate the good processing properties of its new BOPE masterbatches. As these pilot tests have shown, films produced with them meet high optical and functional requirements without compromising mechanical properties.

In addition, Tosaf has demonstrated the good processing properties resulting from the use of the new additives on one of the most advanced production lines available today. The results also demonstrate the suitability of the new BOPE ad-



(©muph/Shutterstock.com)

ditives for the production of inline machine direction oriented (MDO) films, which are emerging as another strong production trend.

■ Tosaf Compounds Ltd.  
tosaf.com

## Joint Venture in India Established

■ A decade of successful collaboration between FKUR and India's SKYi, acting as distributors of the FKUR bioplastics range, has laid the foundation for a promising presence in the Indian market. Both companies finally established the SKYi FKUR Biopolymers Pvt Ltd joint venture at the end of 2019 to further strengthen their cooperation.

The local production of biodegradable, partially bio-based plastics has now begun. This is a further step in implementing the FKUR mission to leave the world a little better than we found it by using sustainable plastics solutions. The production site is located within a special industrial zone in Chakan in the Pune district of the state of Maharashtra. This zone accommodates over 2000 large and small companies.

*Joint Venture SKYi FKUR Biopolymers started production of biodegradable, partially bio-based plastics. From left to right: Amit Jagtap (Director SKYi FKUR Biopolymers Pvt Ltd.), Nikhil Kurankar (Head of Operations, SKYi FKUR Biopolymers Pvt Ltd.), Dr. Sachin Jain (Director at SKYi FKUR Biopolymers Pvt Ltd)*



The joint venture produces a significant part of the BioFlex® product range for local demand as well as for distribution to neighbouring regions. This makes the JV the first dedicated manufacturer of compostable biopolymer compounds in India.

Patrick Zimmermann, member of the executive board of FKUR Group explains this strategic step: "After our participation at Plastindia 2012, it was clear to us that the Indian continent is a strategically important bridgehead and a hub for our products in Asia and Africa as well."

In addition, Carmen Michels, also a member of the FKUR Group executive team and one of the four directors of the JV adds, "Given the global drive to reduce consumption and disposal of single-use plastics, reduce plastic waste and adopt sustainable solutions, the demand for compostable plastics is also growing in these regions, with a focus on packaging and catering applications, as well as agribusiness. In particular, compostable plastics can make a positive contribution to waste management in India, as setting up organic recycling is infinitely easier and less costly compared to other disposal options (such as mechanical recycling or thermal recovery)."

The plant built for this purpose will employ up to 40 people in the first expansion phase. A modern compounding line is run on three shifts. In the company's own testing laboratory, which contains a small blown film line along with other equipment, the qualities of the incoming raw materials and the end products are monitored according to German standards.

■ FKUR Kunststoff GmbH  
www.fkur.com, www.fkur-polymers.com

SKYi Innovations LLP  
www.skyi.in, www.compostable.in

## Joining the Circular Plastics Alliance

■ Clariant announced it has officially joined the EU Circular Plastics Alliance. The alliance aims to enhance plastics recycling in line with the objectives of the EU Circular Economy Action Plan and the Green Deal program. Clariant's engagement is part of the company's active support for the transition towards a more circular plastics economy.

Clariant is committed to the Alliance's goal to boost the EU market for recycled plastics to 10 million tons by 2025. The company's focus is on addressing the obstacles that are hampering a higher circularity of products within the plastics value chain, in line with the waste hierarchy principles. Clari-

ant's strategy is based on a smart combination of design for reduction, recycling, and reuse options, as well as solutions for mechanical or chemical recycling.

In 2019, Clariant also established EcoCircle, a company-wide initiative that goes beyond a product focus, looking at the entire value chain, identifying the most sustainable and viable solutions for a circular plastics economy.

■ Clariant  
www.clariant.com

## Next-Generation Space-Saving Scanning Measurement System for Narrow Web Processes

■ NDC Technologies, a leading global provider of intelligent, connected measurement and control solutions, is known across the industry for offering the broadest portfolio of gauging and scanning system technologies. Listening closely to the market and customer needs, the R&D team at NDC recently released its SlimTrak II scanning measurement system.

SlimTrak II is the next-generation, single-beam scanner that is uniquely designed to fit into the tightest machine spaces. The very compact footprint requires minimal installation space, allowing you to capture critical measurements. SlimTrak II offers applications versatility and can be used on production lines across a range of processes including lacquer coating on foil, adhesive tapes, label stock, hotmelt coaters, dry lamination, re-moisturizing, water-based coatings, extrusion coating and laminating, and sheet extrusion, to name a few.

Performance-wise, SlimTrak offers the best value for the investment. Benefits include:



- Extremely compact footprint allowing you to capture critical measurements
- Robust scanning measurements for all converting and film extrusion applications
- Built for high performance with engineered-beam construction for excellent scanner rigidity
- Easy maintenance for maximum uptime via easily accessible, modular replaceable parts
- Low cost of ownership from long-lasting, reliable, trouble-free operation

■ NDC Technologies Inc.  
www.ndc.com

## Liaison Office in Turkey

■ UBE Industries, Ltd. announced that UBE Corporation Europe S.A.U. (UCE)'s consolidated subsidiary, UBE Europe GmbH (UEG), has established a liaison office in Istanbul, Turkey, which aims to engage in developing markets and expanding services for products offered by the UBE Group. This is the first office in the Middle East region belonging to the UBE Group chemical business.

As the UBE Group's companies based in Europe, UCE and UEG's main operations are the productions of chemical products as well as market development and material procurement for products of the UBE Group. Turkey is a strategic location for European companies as it is considered a gateway to the Middle East from Europe. The establishment of the liaison office is aimed at capitalizing on market growth in Turkey and surrounding areas by engaging in marketing for nylon resins and fine chemicals that are the main products of UCE and UEG, as well as other products offered by the UBE Group. Through its holding company in Europe, the UBE Group will seek to accelerate its business expansion efforts by leveraging advantages in Turkey: including its geographic location and the favorable regulatory environment for foreign companies.

The UBE Group is developing its global business centering on growth markets in emerging countries, such as establishing subsidiaries in Asia and Latin America. By opening this new liaison office in Turkey, the Group will seek to expand its business in the Middle East region.

■ UBE Group  
https://ube.com

## Portfolio expanded

■ Since 2015, K.D. Feddersen Ueberseegesellschaft mbH, with its Polymers & Compounding Technology business unit, is mainly selling the extrusion grades of polyketone from Hyosung Chemical to the compounding industry.

In addition, all the polyketone material grades belonging to Hyosung's POKETONE™ brand are now also supplied by K.D. Feddersen GmbH & Co. KG and its regional subsidiaries in Germany and Europe. With this engineering plastic, the distributor places its special focus on application-technical advice.

With this engineering plastic, the distributor places its special focus on application development support.

Even the raw materials olefin and CO and their use for the polymerisation are special. POKETONETM is versatile, has various approvals, including FDA, KTW, WRAS and can therefore be used for food applications, drinking water applications, cosmetic packaging or toys. Flame-retardant products with UL approval are also available. The good tribological properties and the high chemical resistance are to be emphasised. The gas and hydrocarbon barrier properties of polyketone are also outstanding and at the highest level compared to other polymeric materials.

At K.D. Feddersen, various polyketone compounds from the Korean manufacturer are available in black as well as in natural for self-coloring. In cooperation with AF-COLOR, a branch of the sister company AKRO-PLASTIC GmbH, individual masterbatch solutions can be offered.

■ K.D. Feddersen GmbH & Co. KG  
www.kdfeddersen.com

## New 500 Series Rubber/Silicone Extrusion Crosshead

■ Guill Tool introduces the NEW 500 Series crosshead with MAGS gum space adjustment. The 500 Series is designed specifically for the flow characteristics and unique processing challenges of elastomeric compounds. One of the key features engineered by Guill on this new crosshead design is the mechanically assisted gum space (MAGS) adjustment system. This new method of gum space adjustment allows the operator to make an effortless adjustment from a single point using a common socket wrench. No more need to struggle with multiple nuts and bolts in order to adjust gum space, which leads to faster adjustments. The visual indicator on the core tube allows the operator to see how far the gum space has been moved, making those adjustments much more accurate and repeatable.

The hardware-free and patented cam lock design of the NEW 500 Series from Guill means no time is wasted unbolting and re-securing fasteners for disassembly and re-assembly. Only half of a rotation of the cam nut is required to loosen and automatically extract the deflector from the head body, which is another time saver. Also, with no undercuts on the deflector, there are no material hang-ups when extracting the deflector, allowing for faster and easier cleaning and changeover. The NEW 500 Series also features the latest Center-Stage concentricity adjustment system that significantly reduces pressure on the tooling, allowing easier and more precise concentricity adjustments without loosening the face bolts. Easy-Out inserts for the adjusting bolts also allow simple replacement of locked or damaged adjusting bolts, which further saves on repair and downtime.

Another innovative feature of this new rubber/silicone crosshead is a cast aluminum liquid-fed cooling sleeve that allows the user to switch out the cooling jacket in the event of a line obstruction, again reducing downtime compared to traditional integrated cooling systems.

The NEW 500 Series crosshead with MAGS gum space adjustment is a drop-in replacement on most existing NRM lines,

however this crosshead design can also be adapted to fit any extruder design or line layout.

The addition of a newly designed flow inlet channel reduces the shear and heat that is generated as the materials are being processed. This leads to lower head pressures allowing the material to move through the head in a much more balanced and even flow.

All crossheads supplied by Guill are furnished with a tool kit for assembly and disassembly as well as a detailed operator's instruction manual. The engineering team at Guill will gladly assist users in the implementation and operation of the NEW 500 series crosshead.

For a video of the NEW Guill 500 Series crosshead with MAGS gum space adjustment, please go to:

<https://youtu.be/jeNovmMtcBs>

■ Guill Tool & Engineering Co., Inc.  
[www.guill.com](http://www.guill.com)

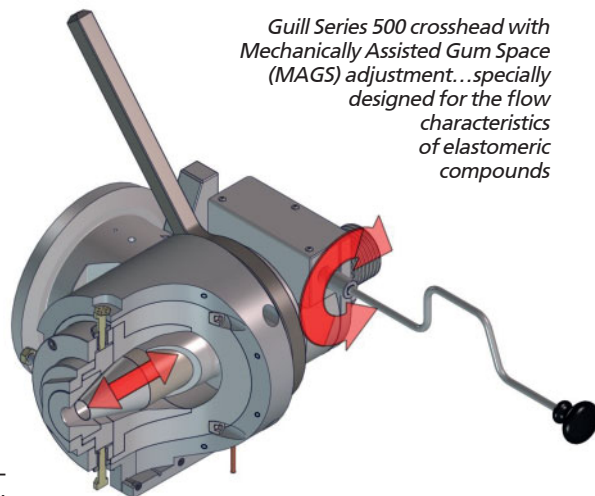

*Guill Series 500 crosshead with Mechanically Assisted Gum Space (MAGS) adjustment...specially designed for the flow characteristics of elastomeric compounds*

## Capacity Expansion

■ SI Group announced the decision to double tackifier resin capacity at its Bethune, France manufacturing site. The expansion will propel the site to become a regional hub for best-in-class tackifier and reinforcing resin production and technology.

The investment, slated for completion later this year, addresses an increasing demand for Novolac tackifiers in one of our core regions. "We have taken the decision to further grow capacity as another step forward in reinventing our business model," stated Robert Kaiser, Vice President, Rubber & Adhesives Solutions at SI Group, adding, "This expansion

will not only benefit the region's supply, but will provide superior solutions at the highest reliability of supply to all our customers globally."

SI Group has a long history of manufacturing tackifier resins used to enhance the performance and durability of tires. In addition to tackifier resins, the company also has a robust portfolio of antidegradants, bonding, curing, and reinforcing resins, manufactured globally. This expansion follows the company's announcement in September 2020 to also expand resin capacity in Nanjing, China.

■ SI Group  
[www.siigroup.com](http://www.siigroup.com)

## New Vacuum Technology Optimises the Production of High-Performance Oriented Films

■ Hosokawa Alpine presents a further development of the Machine Direction Orientation (MDO) technology. The new generation of Alpine's MDO lines is equipped with a vacuum roll which optimises the production of high-quality oriented film. MDO technology is based on monoaxial orientation. It opens up the possibility of specifically adapting and improving the optical and mechanical properties of the end product. Barrier properties, optics or film thickness can be modified. Depending on the MDO design, the film runs over eight to twelve rolls, two of which are stretching rolls. The second of these is now a vacuum roll with a porous surface. Due to the vacuum inside the stretching roll, the film is guided tightly against the roll. This significantly improves flatness and the MDO film is optimally prepared for lamination or printing.

The Hosokawa Alpine MDO technology is a crucial component in the production of high-performance mono-material composites made of polyethylene. This has a particular impact on the material cycle: until now, in order to generate certain product properties, composites of different materials were produced, which cannot be fully recycled. Full-PE packaging solutions, i.e. films made from pure polyethylene composites, are a more environmentally friendly concept. These can be fully recycled after

their original use and reused in the circular economy for end products without material loss. This combines sustainability and resource conservation. Hosokawa Alpine can already look back on numerous successful projects with partners, in which high-performance and resource-saving packaging of the future has been produced.

In the past, the patented Hosokawa Alpine TRIO technology ("Trim Reduction for Inline Orientation") has already provided significant material savings in edge trimming. In addition to this innovative solution, the new vacuum roller also reduces the neck-in by up to 70 per cent. Neck-in means the reduction in usable width due to the material being pulled apart. So the significant neck-in reduction saves further resources.

■ Hosokawa Alpine Aktiengesellschaft  
[www.hosokawa-alpine.de](http://www.hosokawa-alpine.de)



Hosokawa Alpine MDO

## Collaborative Project in Sweden intensified

■ Borealis has commenced a new project to secure an increased supply of chemically recycled feedstock for the production of more circular base chemicals and polyolefin-based products. A feasibility study for a chemical recycling unit to be established at the Borealis production location in Stenungsund, Sweden is now underway. Funded in part by a grant awarded by the Swedish Energy Agency, the study is being carried out with project partner Stena Recycling. Provided a successful feasibility study and final investment decision, operations are expected to begin in 2024. The unit will help accelerate the transformation to plastics circularity by enabling the replacement on a larger scale of fossil-based feedstock by integrating more chemically recycled feedstock via the mass balance model. Borealis Stenungsund has been ISCC PLUS certified since February 2021.

Borealis will also co-operate independently with Fortum Recycling and Waste on a project involving the sourcing of plastic waste to the chemical recycling unit.

*Aerial view of Borealis production location in Stenungsund, Sweden  
 (Photo: © Borealis)*



### Advancing plastics circularity with chemical recycling

As a complement to mechanical recycling, chemical recycling has an important role to play in closing the material loop on plastics circularity. This is because plastic waste streams of lower quality can be recycled chemically into high-quality base chemicals (including olefins) and polyolefins. In fact, olefins produced from chemically recycled synthetic crude oil offer the same high quality as olefins produced from fossil fuel-based crude oil. This allows for the production of high-end polyolefin-based applications.

These include healthcare and food packaging materials subject to stringent quality and safety regulations which cannot always be met by mechanically recycled materials.

Borcycle™ C is the driving force behind Borealis endeavours in chemical recycling. Along with Borcycle™ M – in which "M" stands for mechanical recycling – it forms the Borcycle™ portfolio of all-round solutions for plastics circularity based on the technology suite Borcycle™ launched in 2019. Borcycle™ is transformational because it gives post-consumer plastics a new life; it continues to evolve thanks to innovation and value chain co-operation. Borcycle also is part of the EverMinds™ platform and its ambition for accelerating action on circularity.

■ Borealis AG  
[www.borealisgroup.com](http://www.borealisgroup.com)

## Cooperation

■ As a family-owned business spanning three generations and 60 years, Poly Vinyl Co. of Sheboygan Falls, Wis., thrives in the custom extrusion segment. Instrumental to their success is Davis-Standard extrusion technology and ongoing aftermarket collaboration that supports a diverse product range. Poly Vinyl Co. employs standard, co-extrusion and tri-extrusion processes to produce custom profiles for multiple industries, including large appliance, commercial refrigeration, building products and several OEM's. Not only has Poly Vinyl Co. turned to Davis-Standard for nearly every extruder over the years, but they have taken advantage of upgrade and rebuild services to enhance processing options and extruder performance.

"My father, James Schnettler, has been working with Davis-Standard extruders for over 43 years. Matching products and profiles to the right extruder has always been a point of pride for us," explained Mark Schnettler, Poly Vinyl's President. "It's nice to buy brand new machines, but that isn't always necessary. This is especially true with Davis-Standard because their gearcases are designed to run thousands of hours. If the gearing is set up properly and the right feedscrews are used, you're going to have positive long-term results. We also have an excellent maintenance program and make appropriate upgrades and changes based on materials."

Poly Vinyl Co. runs several Davis-Standard co-extruders for its dual-durometer processes ranging from 1.25 to 1.5 inches (32 to 38mm) as well as 28 main extrusion lines, all equipped with Davis-Standard extruders and feedscrews. These extruders range from 2 inch (50mm) 24:1 single screw models to GC-65 conical twin-screw designs and are engineered to process polyethylene, polypropylene, PVC, polycarbonate, and ABS; among others. Over the past 10 years, Poly Vinyl Co. has worked with Davis-Standard on five major rebuilds to boost processing capabilities. These include conical twin-screw extruder upgrades

*Mark Schnettler with the recent rebuild of a 3.5-inch (90mm) Davis-Standard extruder*



as well as a recent rebuild of a 3.5-inch (90mm) Davis-Standard extruder, purchased via the used market, which was completed in less than 12 weeks. In all cases, Poly Vinyl Co. has been pleased with turn-around time and processing results, which have added value to customer products. Schnettler credits the attention to detail by Davis-Standard's aftermarket department and their collective working relationship with his team at Poly Vinyl Co.

"Joe Guigli and his team have really helped us with our extruder knowledge, maintenance procedures, and in getting the most out of our machines," said Schnettler. "Davis-Standard is very timely in their response, which has been especially helpful during COVID. They are also great at record-keeping, which helps us work through any challenges."

In addition to outstanding equipment capabilities, Schnettler says Poly Vinyl's employee-driven culture, sales focus and operations execution has been paramount to their competitive advantage.

"The fact that we are a multi-generational family-owned business with 130 talented employees makes us unique. As we look to expand, we will continue to carry out the good work that our customers expect while enjoying the journey along the way."

► Poly Vinyl  
polyvinyl.com

Davis-Standard, LLC  
davis-standard.com/market-solutions/

## LFT-D Line with 2,500-Tonne Press Ordered

■ Continental Structural Plastics (CSP), one of the world's largest manufacturers of composite components, is expanding its facility in Sarepta, Louisiana in the US, with the purchase of an LFT-D line that includes a DIEFFENBACHER press with a pressing force of 2,500 tonnes (25,000 kN). CSP will use its new LFT-D line, scheduled to begin operating in the first quarter of 2022, to produce tailgate covers for pickup trucks.

*DIEFFENBACHER hydraulic press at CSP's Sarepta, Louisiana, site*

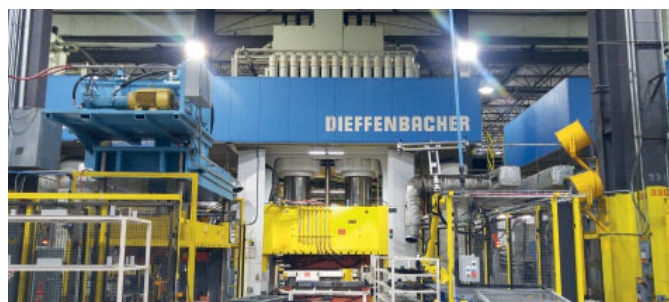

CSP has operated three DIEFFENBACHER LFT-D lines with identically constructed presses in Sarepta for 20 years. "Our DIEFFENBACHER lines from 2001 have done an excellent job for two decades. That's why we've decided to order another LFT-D line with a 2,500-tonne hydraulic press from DIEFFENBACHER," said Dale Armstrong, Advanced Process Engineer at CSP. "In addition, we always feel very well supported by the local DIEFFENBACHER staff here in North America," he added.

A Teijin Group Company, CSP manufactures composite components for a variety of industries, including automotive, trucking, leisure and construction. CSP is headquartered in Auburn Hills, Michigan, and operates facilities in the United States, Mexico, France, Portugal, Czech Republic and China.

► Dieffenbacher  
www.dieffenbacher.de



## Material Tests on Shredder-Extruder Machines – Service Offering for Customers in North America Expanded

■ What is already common practice at the company's location in Ansfelden, Austria, PURE LOOP now makes possible in North America as well. Now, the specialist for shredder-extruder recycling solutions also offers customers and potential buyers in North America the opportunity to test the ISEC machine using their own material.

An ISEC evo 302 machine has been commissioned for this purpose at the technical centre of sister company EREMA

*PURE LOOP now offers material tests at its sister company's technical centre at EREMA North America. The ISEC evo 302 E shredder-extruder combination can be operated in different configurations, depending on the material to be recycled (Photo: PURE LOOP)*



North America in Ipswich, MA, (ENA for short). The machine is built in modules so it can be configured to meet different requirements for degassing, filtration and other performance parameters.

"The USA and Canada are important markets for the in-house recycling segment that we serve with our local sales partners. With this machine that our American customers can also use to carry out non-binding test runs with their material, we confirm the significance of this market," says Manfred Dobersberger, Managing Director of PURE LOOP.

Following the test run, customers receive a detailed test report containing the quality values of the recycled pellets produced. If needed, customers can also attend the test run in person – it's the perfect opportunity to get an impression of the ISEC machine during operation and find out how easy it is to operate for producing high quality recycled pellets. "If this is not possible due to Corona or for other reasons, customers can also attend during a live video conference, or receive a video recording of the test," explains Kevin Hinterberger, who as Sales Manager at PURE LOOP is also responsible for coordinating the material tests.

PURE LOOP  
www.pureloop.at

## Director of International Sales for Extrusion Systems Promoted

■ Graham Engineering Corporation has appointed Vladimir Ilyutovich to be Director of International Sales for Extruders and Systems.

In this position he will oversee the growth of the company's technologies in Europe, Africa, the Middle East, Asia, and Australia. He will be responsible for commercial management of Welex sheet lines, Graham Engineering extrusion blow molding systems, and American Kuhne systems for medical tubing, wire and cable, film, profiles, and compounding.

"Vladimir's deep experience in extrusion of all types will be an invaluable asset for Graham Engineering in serving these growing markets," said Michael Duff, Vice President, Sales and Service.

Vladimir Ilyutovich joined Graham Engineering Corporation in 2014 as director of international sales for medical systems. He holds a Master of Science in Mechanical Engineering degree from the Moscow Institute of Chemical Engineering.

Vladimir Ilyutovich



Graham Engineering  
www.grahamengineering.com

American Kuhne  
www.americankuhne.com

Welex  
www.welex.com

## Next-Generation Case Packer with Collaborative Robot Automation System Launched



■ Proco Machinery, a leading manufacturer of automation systems for the blow molding industry, has unveiled the next generation of its Pakman case packer which is integrated with Yaskawa Motoman HC10 and HC20 collaborative robots for greater efficiency and automation for blow molded bottle manufacturing lines. These systems efficiently handle blow molded containers and deliver a major cost reduction versus conventional automation.

Proco's case packer has seen several generational changes which have delivered greater efficiencies with the focus of bringing innovative technology to bottle packaging. The latest iteration is a breakthrough collaborative robotic auto-

mation system that works interactively with co-workers and needs minimal training for teaching new tasks.

Tooling considerations are important in the development of cobot systems for the blow molding of plastic containers. Proco's Pakman case packer features a collating indexing accumulation system to accumulate complete layers of bottles inside the packaging cell. The accumulation table stages the layer of bottles so they can be picked up by Proco's end-of-arm (EOA) tooling and placed inside the box.

Traditional robotic movement by row would slow the cycle time of the packaging system. The accumulation indexing conveyor helps to increase the line speed of the Pakman packaging cell since there will be one movement of the robot per layer. PET containers – due to high static of the heated bottles – tend to repel each other when they are close together. The layer pack EOAT technology ensures that containers are placed inside the box as a complete layer, preventing any change of bottle position.

Another innovative feature is Proco's Integrated Rotary Inverting Technology which helps to rotate a layer of bottles to neck-down orientation. Proco's Pakman packaging cell has the new advanced innovative feature that will help the processor pack bottles in all neck-down orientation in a layer formation. This feature does not change the packaging cell size. It is an add-on feature that can be purchased at a later date and fitted to the line.

■ Proco Machinery Inc.  
[www.procomachinery.com](http://www.procomachinery.com)

## Significant Additives Expansion in the U.S.

■ SI Group announced plans to invest more than \$50 million across three manufacturing sites in North America to install globally competitive main antioxidant capacity to increase its supply for this critically important and growing market segment.

This investment demonstrates SI Group's commitment to the expanding U.S. chemical market, with a focus on supplying strategically located, critical raw materials to key partners in the region. With SI Group's current extensive antioxidant manufacturing footprint in the U.S. and backward integration, this planned expansion will increase its security of supply by offering a fully integrated portfolio of phenolic antioxidants in the U.S. These performance additives are broadly used in growth segments such as food packaging, automotive, construction, adhesives, and other applications.

"This capacity expansion plan is a direct result of our focused efforts on growth and responding to our customers' needs. The investment will increase domestic capacity and security of

supply for our customers and strengthen SI Group's position as a partner of choice," said Chuck Reardon, SI Group's VP – Plastics Solutions. "We are pleased to be in a position to invest in SI Group's capacity and support the success of our customers as well as bring new manufacturing and product capabilities and manufacturing jobs to our local communities."

The new capacity is expected to come online in the second half of 2022. These projects are expected to create short-term construction jobs, followed by permanent manufacturing jobs once construction is complete. With projected growth in the polyolefins market in the U.S., the expansions will enable SI Group to increase its domestic supply to match growing demand, and further strengthen its position as a key partner to its customers.

■ SI Group  
[www.siigroup.com](http://www.siigroup.com)

## Vice President of North America Operations Named

■ Amcor Rigid Packaging has announced the appointment of Dan Murphy as Vice President of North America Operations. He will be responsible for driving ARP's North American safety agenda, promoting operational excellence, increasing supply chain capability, and expanding the company's production capacity.

"Dan's leadership will bring a new level of service to our operations," said Eric Roegner, President of Amcor Rigid Packaging. "Dan has a proven track record in delivering solid improvements in safety, productivity, quality, and delivery. He's a highly successful business leader who brings a unique skill set immersed in operational excellence."

## Vice President and General Manager of Latin America Named

■ Amcor Rigid Packaging has announced the appointment of Rodrigo Lecot as Vice President and General Manager of Latin America.

"Rodrigo is a visionary leader who has strong relationships with our largest customers throughout the region," said Eric Roegner, President of Amcor Rigid Packaging. "He skillfully

builds global teams that are culturally diverse and establishes best-in-class business practices to drive revenue growth."

Lecot joined Amcor in 2016 as Regional Vice President in Latin America leading Sales, Marketing, R&D, and Sustainability. Under his commercial leadership, Amcor has assisted global and local customers to support market demands, develop new products, and advance sustainability agendas. Lecot also expanded the region's use of technologies including one-step manufacturing, aseptic filling, and EBM.

He has a passion for bringing more sustainable packaging solutions to customers and has spearheaded countless glass-to-plastic conversions and increased the use of PCR across the product offering as well as the availability of refillable and reusable rPET bottles that continue to gain popularity in the region.



*Rodrigo Lecot*

■ Amcor  
[www.amcor.com](http://www.amcor.com)

## Statement on Canadian Government's "Toxic" Label Released

■ The Canadian government continued its push to label plastic a "toxic" material, publishing an order-in-council in the Canada Gazette Part II that opens the door for the creation of rules to officially ban certain types of plastic products.

Tony Radoszewski, President and CEO of the Plastics Industry Association (PLASTICS), warned that false labeling could have devastating effects on cross-border trade, jobs in the U.S. and Canada, and working people depending on plastics for safety, convenience, and affordability: "Our two countries are powerful plastics economies. This development is a symbolic gesture to activists and threatens tens of billions of dollars of commerce. The idea that plastic is toxic is the true danger. Such a label could have ramifications far beyond some single-use items. It could fast-track more bans on other consumer products that are fully recyclable. Our main concern

should be improving recycling. Banning a material that has transformed modern medicine in the name of public health is absurd, especially during a pandemic necessitating plastic gloves, masks, ventilators, vaccine packaging and more. When we're so close to real solutions, we shouldn't pursue policies that reverse course on progress and punish ordinary people."

Radoszewski previously penned an op-ed in The Houston Chronicle about the potential effects of a false "toxic" label for plastics. PLASTICS also joined dozens of industries and their employees to urge the Canadian government to reconsider its actions.

■ The Plastics Industry Association (PLASTICS)  
[plasticsindustry.org](http://plasticsindustry.org)

## Automatically Hopper Device Enables to Accurately Dosing

■ A pneumatically operated device that is deployed inside one of the hoppers in a gravimetric blender makes possible accurate dosing of regrind, recycled plastics, and other ingredients that tend to agglomerate or “bridge,” obstructing flow through the dispense valve of the hopper.

Maguire has introduced the new “bridge breaker” for its three largest blender series, those with maximum throughput capacities of 5,000 kg/hr, (11,000 lb/hr) and capability of blending up to twelve ingredients. The bridge breaker consists of: 1) hopper insert that directs material straight down onto the dispensing valve; and 2) a rotary device that operates automatically while the dispense valve is open. The device rapidly pulses between clockwise and counter-clockwise movement, enhancing material flow through the dispense valve.

The hopper insert, which provides a vertical alternative to the sloping wall of the hopper, can be retrofitted in any blender



*Blenders with Hopper Extensions*



*Hopper Insert with Bridge Breaker*

currently in operation. To make up for the space occupied by the insert, the complete hopper assembly includes an extension to accommodate the desired quantity of material.

The three large-capacity Maguire® blender families, the 1200, 2400, and 3000 Series, blend up to twelve ingredients, using a wide range of removable hopper and feeder configurations and numerous dispensing devices. The blenders handle raw materials in a variety of forms, including regular pellets and regrind, bulk powders, flake, and ingredients that are especially bridge-prone, such as wood flour. As with other Maguire weigh scale blenders, once all ingredients are dosed into the weigh chamber, the batch falls into a mixing chamber. A microprocessor makes corrections from batch to batch, including adjustments to compensate for variations in extrusion rate or bulk density, maintaining overall batch accuracy to within +/- 0.1%.

► **MAGUIRE PRODUCTS, INC.**  
[www.maguire.com](http://www.maguire.com)

## Mourning The Loss Of One Of Their Own

■ Processing Technologies International (PTi) is saddened to announce the passing of one of its members on May 17, 2021 – Enrique “Ricky” Torres. Ricky was a Processing Engineer Technical Specialist with PTi for 20 years, and had over 40 years of experience in the plastics industry. Having been a plant manager prior to working with PTi, he had both hands on experience and a thorough understanding of extrusion equipment and related processes, making him extremely knowledgeable and well respected among all that worked with him.

Ricky set a high bar for himself in his professional life. He truly characterized someone full of company spirit and enthusiasm for the work. He loved this industry and the craft that he was so talented at – teaching others how to process plastic. Ricky is preceded in death by his wife Minerva and is survived by his two children and three grandchildren.

*Processing Engineer  
 Technical Specialist  
 Enrique “Ricky” Torres*



► **Processing Technologies International, LLC (PTi)**  
[www.ptiextruders.com](http://www.ptiextruders.com)

## New Flame Retardant Wire and Cable Jacketing Compounds Receive „Halogen-Free“ Assessments

■ UL has recognized four new Halguard® low-smoke, flame retardant jacketing compounds as “halogen-free”, it was announced by Teknor Apex Company. The compounds include new-generation EVA-based products with an enhanced balance of properties, and highly flexible TPE-based products that exhibit excellent oil and sunlight resistance.

The assessment of halogen content was conducted in accordance with UL 2885 standard for the presence of fluorine (F), chlorine (Cl), bromine (Br) and iodine (I) at a maximum individual limit of 1,000 ppm. With the four new grades, there are now fifteen Halguard low-smoke, halogen-free flame retardant (LS-HFFR) compounds with UL AATJ2 component recognition as Halogen-free.

The new compounds, all with UL 94 flame ratings of V-0, are of two types:

- *EVA-based compounds for control, data, and transit cables.* Halguard grades 58240 and 58242 provide high levels of flame retardance, resistance to heat shock and heat deformation, and ease of processing – the latter translating into increased throughput. The compounds enable cables to comply with UL 1685-FT4/IEEE 1202 standards for vertical tray cable and the UL 1666 standard for riser cable. Other applications include fiber optic data cables and cables used in transit infrastructure, as in the case of tunnels.
- *Highly flexible, oil- and sunlight-resistant TPE-based compounds.* Incorporating elastomers, these two products comply with UL 62 and UL 758 standards for flexible cord and appliance wire, respectively. Halguard E 59001 exhibits 80% and 90% retention of tensile strength and elongation at break, respectively, upon immersion in IRM 902 oil for seven

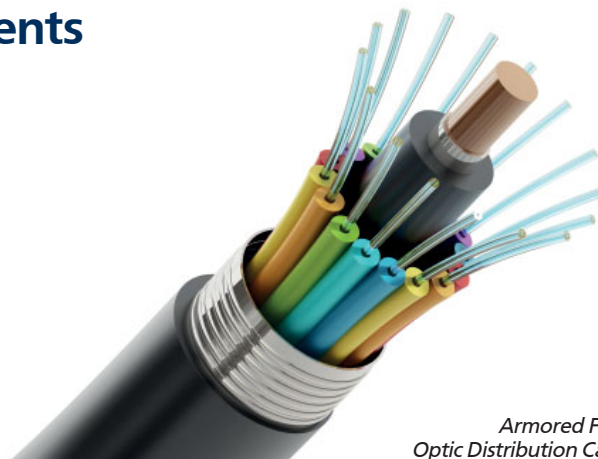

Armored Fiber  
Optic Distribution Cable

days at 60 °C. Halguard E 59002 retains 90% and 95% of tensile strength and elongation at break upon exposure for 720 hours in a weatherometer.

“The Halguard LS-HFFR product line provides properties to meet a wide range of applications, and the growing list of grades with ‘halogen-free’ assessments by UL further expands options for customers,” said David Braun, wire and cable industry manager for the Vinyl Division of Teknor Apex. “We will continue to develop Halguard compounds which can comply with this UL assessment in order to provide customers with readily available component recognition, which enables them to accelerate speed to market for their products.

Halguard LS-HFFR compounds are available worldwide.

■ Teknor Apex Company  
[www.teknorapex.com](http://www.teknorapex.com)

## Tackifier Capacity Expansion in India Announced

■ SI Group announced the decision to increase tackifier resin capacity at its Lote, India, manufacturing site by an expected 75%. The expansion will propel the site to become a regional hub for best-in-class tackifier resin production and technology.

The investment addresses an increasing demand for Novolac tackifiers in one of our core regions. The expansion is slated for completion in two phases. The first phase will be completed by the end of 2021 and the second phase will commercialize in the latter half of 2022.

“We have decided to grow capacity as another step forward in demonstrating our commitment to supporting our customers’ growth and positioning ourselves as a leader in specialty additives,” said Robert Kaiser, Vice President - Rubber & Adhesives

Solutions at SI Group. “This expansion will not only benefit the region’s supply, but it will also provide superior solutions at the highest reliability to our customers globally.”

“This investment positions SI Group to supply regional growth and meet strong forecasts within the Indian tires & automobile sector,” stated Suresh Kalra, Vice President & Managing Director India at SI Group. He further said that these investments will strengthen the position of our customers and India’s Rubber Industry moving forward.

This expansion follows the company’s previous announcements to also expand resin capacity in Nanjing, China, and Bethune, France.

■ SI Group  
[www.siigroup.com](http://www.siigroup.com)

# Increase in Turnover on the European Market

*Russian compounder R&P POLYPLASTIC stated its intention to double sales on the European market in 2021. Based on open sources including Datascope, Market Report and Plastinfo the company today holds 33% of the Russian market and increase of export sales to the European Union is a new chapter of development and a crucial strategic goal. Basing on what advantages shall the Russian compounder compete with its European colleagues?*

Today R&P POLYPLASTIC is among Top-10 leading European compounders (based on open sources analysis of Applied Market Information). The company's productive capacity allows to produce 115 thousand tons of materials per year. R&P POLYPLASTIC specializes in the production of thermoplastic compound materials for processing by pressure, blow and extrusion molding. Over 250 brands address up to 90% of the clients' needs.

Recipes for materials are created in the company's Research and Development Centre and can be custom made. "R&P POLYPLASTIC develops compounds which have no rivals in Russia and are compatible to the best European analogs," says Mikhail Katsevman, Doctor of Science and Head of R&D at R&P POLYPLASTIC. "One of our most innovative developments is an electro dispersive compound based on polyamide 6 with addition of graphene nanotubes. This material can be painted on cataphoresis lines. Another breakthrough is the Armlen PP-10AS-9010 material without migrating antistatic additives providing a constant level of surface resistance. It can be used for interoperable packaging".

Structure of the company includes three production sites with state of the art equipment of internationally recognized manufacturers: BUSS, Berstorff, Coperion, ICMA and Maris. The largest production facility with 14 extruders is organized in Engels, Saratov region. The second production plant in Togliatti, Samara region has 5 lines. The Moscow experimental-industrial site has 3 lines.

The largest industry in the company's sales pattern is the automotive industry. Materials of R&P POLYPLASTIC are used in production of interior and exterior parts as well as underhood space. The

Togliatti site is fully oriented towards the needs of the auto industry, in particular one of company's largest customers – JSC AvtoVAZ (part of the Renault-Nissan-Mitsubishi Alliance) and its suppliers. Among the clients of R&P POLYPLASTIC are well-known Russian and international automanufacturers including GAZ, UAZ, Volkswagen, Hyundai, PSA Group and KAMAZ. Materials for Haval are at the stage of development.

Civil construction is another important market for R&P POLYPLASTIC. The company's brand assortment is used for production of plinth siding of various appearance (brick like and etc.) as well as central layers of aluminum composition panels.

The third key sphere of application for R&P POLYPLASTIC are producers of household appliances. The company supplies raw materials for production of carcass parts (boxes, dispensers), washing machine drums and other components for domestic appliances. The list of customers includes LG, Indesit, Candy, B/S/H/, Samsung.

"Over the 30 years on the market we became suppliers of leading automanufacturers, producers of household appliances and construction materials. Today we are also focusing on materials for electrical goods. In Russia, CIS and Europe we have over 1000 partners working with materials of R&P POLYPLASTIC. We value their confidence in us for the opportunity to develop together," says Andrey Menshov, Managing Partner of R&P POLYPLASTIC.

Constant development and onward progress is the foundation stone of R&P POLYPLASTIC dynamic progression. In 2021, the year of the company's 30th Birthday, two state of the art twin screw extruders shall be installed at one of the production sites. KraussMaffei Extrusion



will supply the extruders within a previously established contract. A total of 3.3 million Euros were invested into new equipment. Planned capacity of the lines shall exceed 20 thousand tons of finished goods per year. At R&P POLYPLASTIC, they are confident that this will allow to increase export sales even more.

Today the Russian compounder with the help of its extensive distribution network already ships products to Germany, Lithuania, Check Republic and Turkey. Talks are held with dealers in Slovakia. In April 2021 first 10 tons of compounds were dispatched to Poland via one of the largest distributors in Eastern Europe – MOBI Sp. z.o.o. "This is our first experience of cooperation with a Russian company and we are glad it was successful. R&P POLYPLASTIC made a good proposal in terms of prices and delivery time. We are truly delighted to represent R&P POLYPLASTIC on the Polish market," noted Tatiana Moj, Plastics Department Director at MOBI Sp. z.o.o.

For successful entry to the European markets in 2017 R&P POLYPLASTIC launched the Export Rush program. In comparison with the start of the program shipments to EU increased significantly: almost six times. Strategic goal of the company is to bring the amount of export sales to 25% of the total sales volume by 2025.

**R&P POLYPLASTIC**  
<https://polyplastic-compounds.ru/eng>

*Fully-automatic, process and pressure constant RSFgenius Back Flushing Filtration System*

*Against a background of government rules prescribing the proportion of recycled polymer, the plastics strategy of the EU and the commitment of many market leaders to responsible use of polymers, the conversion or modification of extrusion lines represents an important trend. The German manufacturer of Filtration Systems, Gneuss, has seen a surge of interest among customers looking to retrofit their extrusion lines*



## PET Bottle to Bottle Recycling – Major Efficiency Improvements by Retrofitting Melt Filtration System

The Gneuss Rotary Filtration Technology ensures an uninterrupted production process under constant conditions – even when post-consumer recycled material is processed. Gneuss Melt Filtration Systems are especially well suited for retrofitting to existing extrusion lines.

### **RSFgenius Back Flushing Filters as Optimum Retrofit Solution for PET Bottle Flake Recycling**

The processing of PET Bottle Flakes presents particular challenges for Melt Filtration Systems. On the one hand, the post-consumer material source typically has a relatively high contamination level, on the other hand, the quality requirements (fine filtration) are very high – especially when the material is to be put back into transparent bottles for beverages.

In order that the filter elements do not need to be constantly changed by hand, the ideal Melt Filtration System should be self-cleaning. Typically, the principle of back flushing is used. A proportion of the melt flow is diverted so that it flows in the reverse direction across filter elements which are not in use in order to wash the contamination out. The cleaning efficiency of the back-flushing and the quantity

of material needed for back flushing vary greatly between the different systems available on the market.

With the Gneuss RSFgenius Melt Filtration System, the high pressure sequential cleaning system ensures that the filter elements are completely cleaned with the absolute minimum of polymer.

Nosoplas in Spain decided in favour of the RSFgenius Rotary Filtration System due to the high efficiency and the fast return on investment which it offers. Nosoplas manufactures bottle grade pellets (chip) from PET bottle flake. The pellets (chip) are supplied to other companies, where they are injection moulded to pre-forms which are later blown into high quality bottles for beverages.

Nosoplas decided to replace their existing, conventional filtration system due to problems with back flushing and high polymer losses. They replaced this conventional system with a Gneuss RSFgenius 175 for a throughput of 1.500 kg/h and a filtration fineness of 56 µm. In fact, the customer is even able to operate with 30 µm for special products. And this all with a constant, steady melt pressure, minimal losses due to back flushing and without any production variations, even during replacement of the filter elements.

The expectations that Nosoplas placed on the retrofit with a Gneuss Rotary Filter have been completely fulfilled. Immediately after commissioning the units, a drastic reduction in material loss due to back flushing was observed and, at the same time, the quality of the rPET granulate produced was noticeably improved.

■ Gneuss Kunststofftechnik GmbH  
Mönichhusen 42, 32549 Bad Oeynhausen, Germany  
[www.gneuss.com](http://www.gneuss.com)



*Lindner's new 1500 model from the Micromat series was presented at K 2019 in Düsseldorf, Germany. In impressive live outdoor demonstrations it showcased the shredding of fishing nets as the first step in the recovery process. This very model was delivered to Chilean plastics recycler and circular economy pioneer Comberplast at the beginning of last year and has been successfully shredding old fishing nets and ropes collected from the Patagonian coasts for the past year*



*The nets and ropes discarded on the coasts of Patagonia are collected by locals and taken to collection points*

# Cleaning Up Coasts at the Edge of the World

Nature lovers and globetrotters alike find even the mere mention of this region breath-taking: Patagonia. Besides rugged mountains shaped by Pacific winds and impressive landscapes, it is above all the fjords and coasts that – Covid travel restrictions apart –

attract more and more visitors to this strip of land in southern Chile every year. Michel Compagnon from Santiago de Chile is one of them. Besides the magnificent spectacles of nature, one thing in particular caught his eye: discarded fishing nets and ropes, which

are a burden on the environment and can bring the life of many sea creatures to an unhappy end. When asked about this, the local fishermen simply described the carelessly discarded rigging as waste. But for Compagnon, Commercial Manager at the plastics recycling company Comberplast, the unpleasant scene became a project to save the oceans and the incomparable beauty of Patagonia. And that is how the Atando Cabos project started.

What began in 2016 with a handful of samples in a travel suitcase is now a project that transforms over 3,000 metric tons of ropes and nets into new products every year. The entire recovery process, from shredding and cleaning to the extrusion and injection moulding of new products, takes place on site at the Comberplast

*Ropes and nets are designed to be extremely tear resistant and are usually highly contaminated after use*





facility in Santiago de Chile. For more than 25 years, the company has been committed to the circular economy, even before circular concepts in plastics recycling became the latest buzzword.

The many international awards for environmental protection and innovation confirm Julio JR Compagnon, CEO of Comberplast and co-founder of Atando Cabos, that he is on the right track: „The global awards make me so proud. They show us that another path is possible and that doing the right thing for people and the environment can also be a profitable business. Or to put it another way: the real purpose of business should always be to solve problems in both economically and environmentally sustainable ways.“

The large amounts of old fishing nets, lines and other discarded plastic materials are recycled and converted into innovative new products, for example for the agricultural and mining industries, or also turned into green pallets for an international brewery.

Since 2020, Comberplast has relied on the shredding technology of Lindner's Micromat 1500, equipped with an optimised cutting system from the Mono-Fix kit. Julio Compagnon explains: „We process plastic waste from fish farming and fishing companies. These materials were developed by very clever people not to



*The plastic waste from the fishing and fish farming industries is used to produce, among other things, high volumes of pallets and crates*

ever break or tear. Shredding is therefore an especially big challenge. In processing, we are always looking for new solutions to tackle more difficult projects and to keep production economically viable. In Lindner, we found an experienced partner who was willing to go the extra mile with us – not many companies will do that.“

The delivered materials are usually heavily loaded with abrasive substances such as sand, stones or organic material. That is why, when selecting the shredder, the main concerns besides high

energy efficiency were the costs of wear and tear. Now, after a year in operation, Compagnon is pleased: „We got the Micromat in January 2020 – just at the start of the pandemic. The situation required us to find new ways of commissioning and servicing despite the physical distance. Thanks to the great cooperation of the Lindner team in Austria, the Chilean sales partner Ingeniería Delta Limitada and our technicians here on site, we were able to successfully install and commission the shredder – everyone involved did an excellent job. Since then, our shredder has been running like clockwork and we look forward to many more joint projects in the future.“

*Julio JR Compagnon is pleased with the optimal output from Lindner's Micromat 1500 ready for the next step in the recycling process*



► Lindner-Recyclingtech GmbH  
Villacher Str. 48, 9800 Spittal/Drau,  
Austria  
[www.lindner.com](http://www.lindner.com),  
<https://youtu.be/Dliez63SCf4>

Comberplast S.A.  
Camino Santa Margarita 0830,  
San Bernardo, Chile  
[www.comberplast.cl](http://www.comberplast.cl)

# Reduced Odour – An Indispensable Quality Criterion in Post-Consumer Plastics Recycling

*There has been a noticeable increase in demand for EREMA recycling machine combinations featuring ReFresher technology that reduces odour downstream of the extrusion process. This is due to the growing demand for high-quality post consumer recyclates that can be used for a wide variety of applications. Thanks to the combination of its INTAREMA® TVEplus® Re grindPro® machine with the ReFresher, EREMA has enabled the PCR-HDPE produced with it to be used in proportions of up to 100 percent for the production of packaging for direct contact with food and beverages, as confirmed by the U.S. Food and Drug Administration (FDA)*

*In the EREMA Customer Centre, test runs using an industrial class extruder-ReFresher combination can also be carried out since April onwards. Michael Heitzinger, Clemens Kitzberger and Thomas Hofstätter very much hope that more customer visits will be possible soon (Photo credit: EREMA)*



A total of more than 25 ReFresher modules sold, 19 were ordered in the past 18 months alone. This development goes hand in hand with the enormous increase in interest in the use of post consumer recycle. "Odour is a typical problem with contaminated household waste such as LDPE films, HDPE containers and PE closures. It is essential that odour is removed if the PCR material is to be reused in high quality packaging for cosmetic products or food," explains Clemens Kitzberger, EREMA Group Business Development Manager for Post Consumer Applications. This development is driven by two factors: firstly, the ambitious recycling goals set by the European Union, specifying that by 2025, fifty percent of plastic packaging waste must be recycled, and secondly, the fact that recycling technologies are becoming more and more efficient. "Both of these factors have made possible for post

consumer recycle applications things that were unimaginable a few years ago, and this trend is set to continue. That is because the EU's recycling goals will mean reusing 10 million tonnes of recyclates in new products every year in future," says Kitzberger.

An outstanding example of a high-end product made from post consumer recycle is the cosmetics packaging that was launched as a world first in spring 2019. This was a shower gel bottle made from 100 percent PCR-HDPE. The recycle is produced by an INTAREMA® TVEplus® Re grindPro® machine plus ReFresher module.

## **Closures as additional input for food packaging made of PCR-HDPE**

The superclean recycling process was also certified by the FDA in August 2019 as suitable for the production of

milk and juice bottles, as well as meat trays, disposable tableware and cutlery, provided the input material comes from milk and juice bottles. In November 2020, the FDA confirmed an additional input stream and more application uses for the recyclate treated using this process. In addition to all HDPE beverage containers, HDPE closures of HDPE, PP and PET beverage bottles can also be processed. Material containing up to 100 percent recyclate can be used in the production of containers for direct contact with food of all kinds.

“In order to produce a recyclate of such high quality from PCR material, the recycling machine needs to deliver very high decontamination performance,” explains Thomas Hofstätter, Process Engineer at EREMA GmbH. “While the high degassing extrusion system removes mainly highly volatile, low molecular weight substances, the ReFresher ensures a significant reduction of the low volatile, high molecular weight organic compounds in the recycled pellets. At the same time, the thermo-physical process works in a particularly energy-saving way, because it makes use of the thermal energy of the recycled pellets that are still warm after the extrusion process.”

“In addition to EREMA developments that have been industry-proven for some time, such as our Precondition-

ing Unit with Counter Current and ReGrindPro technology, the combination of the extruder with the ReFresher was a key factor in obtaining FDA approval,” confirms Michael Heitzinger, Managing Director of EREMA GmbH. “This super-clean process produces high-quality recycled pellets that will open up new, economically viable sales markets that can be developed by working together with partners from all along the value chain.”

**Customer tests now possible using industrial-sized ReFresher**  
 People who are interested in the efficiency of this process can come and see it for themselves since April onwards in the expanded Customer Centre at the group’s headquarters in Ansfelden/Austria. An extruder-ReFresher combination for testing is now available for the first time on an industrial scale.

For carrying out tests at the customer’s plant, EREMA also offers a compact and mobile ReFresher module that can be integrated into the on-site recycling process.

EREMA Engineering Recycling Maschinen und Anlagen Ges.m.b.H.  
 Unterfeldstr. 3, 4052 Ansfelden, Austria  
[www.erema.com](http://www.erema.com)

# SMART EXTRUSION

The only website collecting information about smart technologies of extrusion

**34 600 + average monthly visits**

Geographic distribution of **Smart\_Extrusion** readers, %

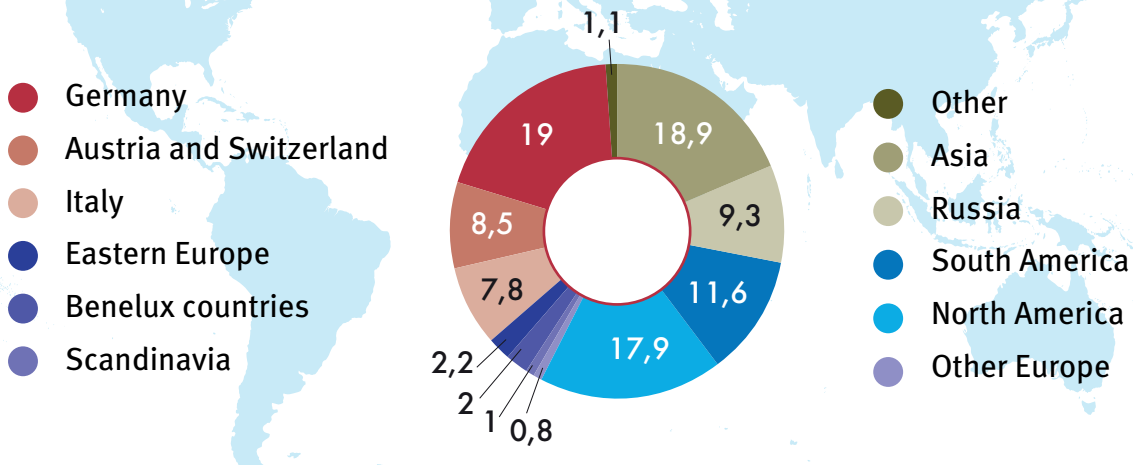

[www.smart-extrusion.com](http://www.smart-extrusion.com)

*The Win CC Open Architecture interface architecture enables BHS Control Systems to create a high-quality foundation for custom control solutions*

*BHS-Sonthofen now offers turnkey control systems for complete plants in the field of recycling and environment thanks to the newly founded BHS Control Systems GmbH & Co. KG. The customer receives complete solutions tailored to their needs, including recycling, control, and automation technology from a single source. BHS provides assistance in transferring the control system to modern systems*



## Service Portfolio expanded – Control Solutions for Complete Recycling Plants

“A lot of companies currently use control systems and software that providers no longer support,” explains Steffen Kämmerer, Chief Technology Officer (CTO) at BHS-Sonthofen and Managing Director of BHS Control Systems. “That is why we are seeing an increasing demand for control solutions when it comes to expanding or modernizing existing recycling plants.” BHS provides an especially high level of safety and flexibility both in the modernization of systems and in new plants thanks to its efficient and open solutions.

BHS-Sonthofen significantly expanded its service portfolio in the area of control and automation technology

*BHS Control Systems offers turnkey control solutions for complete recycling plants*

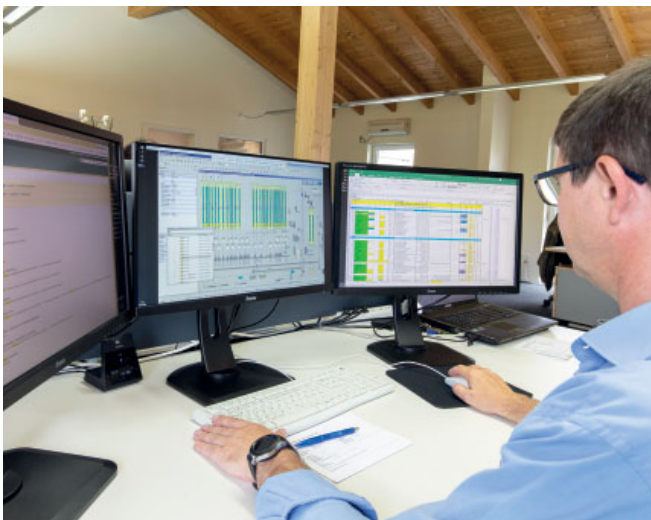

with the acquisition of Thoma Elektrosteuerungsanlagen GmbH from Babenhausen, Germany, on 1 January 2020. Using its more than 30 years of experience and expertise as a basis, the Group now also offers customers engineering, supply, and design services for turnkey plant control systems for major projects in the recycling industry. BHS takes care of installation and commissioning and also provides user support and training.

Customers benefit from the open interface architecture. “Win CC Open Architecture is an open and scalable system that enables a wide range of components to be integrated smoothly and it is suitable for both small and large plants,” explains Kämmerer. BHS uses this as the foundation for custom solutions. The customer can expand the plant as required without the need for major investment in interface management. From a simple small system to a complex high-end system, the architecture is highly adaptable.

Win CC Open Architecture is also platform neutral and runs on Windows, Linux, Android, and iOS. The system has proven itself to be very efficient when being used in everything from user guidance to system connection. BHS develops the individual components of its automation and control technology at its site in Babenhausen near Memmingen, Germany, in exact line the customer’s individual requirements. BHS Control Systems is already implementing a project in the processing of lithium-ion batteries for the Recycling & Environment division of BHS.

**BHS-Sonthofen GmbH**  
An der Eisenschmelze 47 87527 Sonthofen, Germany  
[www.bhs-sonthofen.de/en](http://www.bhs-sonthofen.de/en)

# The Best Recycled Pellets for Irrigation Pipes

*The shredder-extruder combination from recycling technology provider PURE LOOP is an ideal solution for recycling challenging production waste. This category includes drip tapes and irrigation pipes that accumulate as waste during the production of irrigation systems or are rejected during quality inspection. Manufacturers who already implement this technology reuse production waste in the form of recycled pellets in proportions of up to 20 percent - without any loss of quality compared to production from virgin material*

"This level of reuse can still be significantly increased thanks to the high quality of the recycled pellets," says Manfred Dobersberger, Managing Director of PURE LOOP. "The high demands on the recycling process result from the high volume of the bulky input material as well as the material composition of the drip tapes and irrigation pipes," he explains. Their job is to ensure that crops can grow and thrive, using as little water, fertiliser and pesticides as possible. For this purpose, either thin-walled HDPE drip tapes laid on the surface or HDPE irrigation pipes buried in the ground are used. The water is distributed through emitters. In the case of the thin-walled drip tapes (150 to 250 µm), these are LLDPE injection-moulded parts which are spaced at regular intervals of around 20 cm. In the case

*As an all-rounder, the ISEC evo machine processes bulky hose bundles as well as start-up lumps and complete rolls with drip tapes*

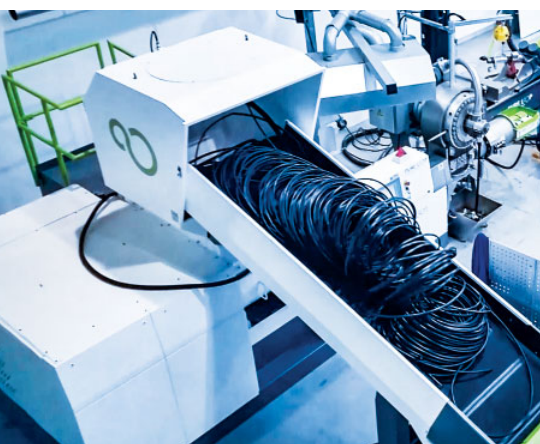

of thick-walled irrigation tubes (over 300 µm), the emitters are also fitted with a silicone membrane for pressure compensation, so that the same flow rate of water is discharged from each emitter over the entire length of the tube and the flow of water is not obstructed by soil, sand or roots growing into the emitter.

## Efficient shredder-extruder combination for gentle processing

The purpose-specific function of the pipes and tapes is tested at regular intervals during the production process. "In order to test whether their irrigation pipes meet the strict quality standards of a maximum of two pinholes per 10 kilometres, one of our customers pressure-tests them with water," reports Manfred Dobesberger. "The proportion of foreign polymers in this material is a real challenge in recycling, but one that our ISEC evo shredder-extruder combination with double degassing and EREMA laser filter can handle with perfectly". In the laser filter, three scrapers rapidly and continuously remove contaminants – which mainly consist of the silicone in the emitters – from the filter screen during each revolution. The efficiency of this filter enables high throughput rates in the recycling process and the highest recycled pellet quality. Further advantages for the user are that, as an all-rounder, the recycling machine processes bulky hose bundles as well as other production waste such as start-up lumps and regrind mate-



*Manfred Dobersberger, Managing Director PURE LOOP, and Merlijn van Essen, Sales Manager PURE LOOP (Photos: PURE LOOP)*

rial or complete rolls with drip tapes. Single-shaft shredders and double feed ram systems flexibly adapt to individual logistic requirements and, thanks to the conical transition to the extruder, the material is compacted and oxygen is reduced, which ensures the plastic material is processed very gently. The entire ISEC evo series also offers straightforward operation and a high degree of automation, and the machines are quickly ready to start processing at any time. This overall recycling concept has already impressed irrigation system producers in the USA, Israel, Italy and Mexico. They operate recycling plants with throughputs of 100 to 500 kg/h and reuse the recycled pellets produced in proportions of up to 20 percent in the production process of thin-walled tapes and thick-walled pipes. However, practical tests have shown that significantly higher proportions of recycled pellets would be possible in the end product. "Even for very thin drip tapes with a wall thickness of 100 µm, we were able to use a proportion of 10 percent recycled pellets in a 48-hour trial without any loss of quality," says Manfred Dobersberger.

**PURE LOOP GesmbH**  
Unterfeldstr. 3, 4052 Ansfelden, Austria  
[www.pureloop.at](http://www.pureloop.at)

# Today's Waste becomes Tomorrow's Resource –

*„Waste4Future“ paves New Ways for Plastics Recycling*

*Keeping carbon in the cycle, thus avoiding plastic waste and emissions: That is the goal of the “Waste4Future” lighthouse project (© Fraunhofer IMWS)*



*A sustainable society with climate-neutral processes requires significant adjustments in the value chains, which are only possible through innovations. Seven Fraunhofer Institutes are pooling their expertise in the lighthouse project “Waste4Future” to develop new solutions for this goal, from the raw material base to material flows and process engineering right to the end of a product's life cycle. In particular, they want to increase energy and resource efficiency in the use of plastics and thus pave the way for a chemical industry that requires fewer fossil raw materials and produces fewer emissions*

Plastics such as polyethylene (PE), polypropylene (PP) or polystyrene (PS), which are currently produced almost entirely from fossil raw materials, are fundamental to many everyday products and modern technologies. The carbon contained in plastics is an important resource for the chemical industry. If it is possible to better identify such carbon-containing components in waste, to recycle them more effectively, and to use them again to produce high-quality raw materials for industry, the carbon can be kept in the cycle. This not only reduces the need for fossil resources, but also pollution with CO<sub>2</sub> emissions and plastic waste. At the same time, the security of supply for industry is improved because an additional source of carbon is tapped.

The "Waste4Future" lighthouse project therefore aims to create new opportunities for recycling plastics in order to make the carbon they contain available as a "green" resource for the chemical industry. "We are thus paving the way for a carbon circular economy in which valuable new base molecules are obtained from plastic waste and emissions are largely avoided: Today's waste becomes tomorrow's resource," says Dr.-Ing. Sylvia Schattauer, deputy director of the Fraunhofer Institute for Microstructure of Materials and Systems IMWS, which is heading the project. "With the know-how of the participating institutes, we want to show how the comprehensive recycling of waste containing plastics without loss of carbon is possible and ultimately economical through interlocking, networked processes." The outcome of the project, which will run until the end of 2023, is expected to be innovative recycling technologies for complex waste that can be used to obtain high-quality recyclates.

Specifically, the development of a holistic, entropy-based assessment model is planned (entropy = measure of the disorder of a system), which will reorganize the recycling chain from process-guided to material-guided. A new type of sorting identifies which materials and in particular which plastic fractions are contained in the waste. Based on this analysis, the total stream is separated and a targeted decision is then made for the resulting sub-streams as to which recycling route is the most technically, ecologically and economically sensible for this specific waste quantity. What cannot be further utilized by means of mechanical recycling is available for chemical recycling, always with the aim of preserving the maximum possible amount of carbon compounds. Burning waste containing plastics at the end of the chain is thus eliminated.

The challenges for research and development are considerable. These include the complex evaluation of both input materials and recyclates according to ecological, economic and technical criteria. Mechanical recycling must be optimized, and processes and technologies must be established for the key points in the material utilization of plastic fractions. In addition, suitable sensor technology must be developed that can reliably identify materials in the sorting system. Machine learning methods will also be used, and the aim is to link them to a digital twin that represents the properties of the processed materials.

Another goal of the project is the automated optimization of the formulation development of recyclates from different material streams. Last but not least, an economic evaluation of the new recycling process chain will be carried out, for example with regard to the effects of rising prices for CO<sub>2</sub> certificates or new regulatory requirements. The proj-

ect consortium will also conduct comprehensive life cycle analysis (LCA) studies for the individual recycling technologies to identify potential environmental risks and opportunities.

For the development of the corresponding solutions, the participating institutes are in close exchange with companies from the chemical industry and plastics processing, waste management, recycling plant construction and recycling plant operation, in order to consider the needs of industry in a targeted manner and thus increase the chances of rapid application of the results achieved.

The following Institutes are involved in the Fraunhofer lighthouse project

"Waste4Future":

- Fraunhofer Institute for Microstructure of Materials and Systems IMWS (lead)
- Fraunhofer Institute for Non-Destructive Testing IZFP
- Fraunhofer Institute for Materials Recycling and Resource Strategy IWKS
- Fraunhofer Institute of Optics, System Technologies and Image Exploitation IOSB
- Fraunhofer Institute for High Frequency Physics and Radar Techniques FHR
- Fraunhofer Institute for Structural Durability and System Reliability LBF
- Fraunhofer Institute for Process Engineering and Packaging IVV

 Fraunhofer Institute for Microstructure of Materials and Systems IMWS  
Walter-Hülse-Str. 1, 06120 Halle (Saale),  
Germany  
[www.imws.fraunhofer.de](http://www.imws.fraunhofer.de)

# 2 Million Tons of Installed Recycling Capacity Worldwide Celebrated

*In spring 2021 viscotec, a division of the Austrian machinery supplier Starlinger & Co GmbH, reached a milestone: an impressive 2 million tons of capacity are available for the production of PET recyclate on viscotec systems worldwide*

To take a look at the recycling quantities in Europe helps to put this number in relation. An estimated 4.3 million tons of PET packaging waste is generated annually in the European Union and around half is actually sorted for recycling<sup>1</sup>. With the capacity installed by Starlinger viscotec, almost the entire amount of collected and sorted PET packaging waste in the European Union could be processed to produce recycled PET (rPET).

## Commitment to recycling

Starlinger viscotec is specialised in sheet extrusion lines and plants for recycling and refinement of PET packaging waste into recyclate in food-grade quality for food and beverage packaging applications. "Our solutions make it possible to recycle valuable raw materials. Our partners and customers share our conviction that PET can and must be recycled," says Angelika Huemer, Managing Director of Starlinger GmbH & Co. "To recycle contains the word

## Closing the loop in PET recycling



Portfolio of PET recycling solutions by Starlinger viscotec

"CYCLE". Closing the loop is exactly what recyclers and packaging manufacturers do with Starlinger recoSTAR and viscoSTAR systems: they produce recyclate which is safe for food contact. A beverage bottle can be turned into a beverage bottle again after recycling." For food packaging, PET/rPET currently meets the requirement of a closed loop. A beverage bottle, however, which after recycling becomes, for example, a car interior trim, goes into a so-called "end-of-life" application and thus is lost for the food packaging recycling loop.

## Why recycled PET (rPET)

PET is of particular importance: it has the highest recycling rate among plastics and is currently the only recycled plastic that is approved for contact with

food in the European Union. "We want to raise awareness that PET food packaging is a valuable raw material. By using recycled PET for packaging, a lot of CO<sub>2</sub> emissions are avoided. Many people are not aware of the fact that the carbon footprint of beverage bottles made from rPET is significantly smaller than that of reusable glass bottles," points out Julia Peherstorfer, responsible for sustainability and marketing at Starlinger viscotec. "Every consumer can contribute by collecting the beverage bottles and packaging via the waste collection system, so they can be recycled. It is the collaboration of consumers that makes it possible for the PET packaging waste to be processed again into new food packaging made from recycled PET (rPET)."

## PET flakes and rPET packaging



<sup>1</sup> Source: eunomia (2020), "PET MARKET IN EUROPE: STATE OF PLAY", retrieved 25.March 2021 from [https://743c8380-22-c6-4457-9895-11872f2a708a.filesusr.com/ugd/dda42a\\_e0c40-c546a7446daa7ba5e0bedd67cca.pdf](https://743c8380-22-c6-4457-9895-11872f2a708a.filesusr.com/ugd/dda42a_e0c40-c546a7446daa7ba5e0bedd67cca.pdf), page 12. An estimated 4.3 million tons of PET rigid Packaging ended its product life and was therefore available for collection in 2018, of which 45% (1.9MT) was collected and sorted for Recycling across the EU-28 countries.

Starlinger viscotec  
[www.viscotec.at](http://www.viscotec.at)

Starlinger & Co. GmbH  
[www.starlinger.com](http://www.starlinger.com)



*From stand-up pouches to laminates, from tapes to functional films for hygiene products: The range of application for MDO films is truly tremendous. SML's know-how on MDO dates back to the 1960s, when the first MDOs were put on the market under the name Lenzing. One of the latest developments in this field is SML's revolutionary dual frame technology that takes service-friendliness of MDO lines to the next level. High production speeds, significantly shorter down-times and a boost in overall line efficiency are the key benefits of the new MDO systems made by SML*



## Dual Frame System Boosts Efficiency

### Maximum profitability for a wide range of products

The most striking feature of SML's latest generation of MDO lines is the new design consisting of two independent frames with an inline adjustable stretching gap. The two frames are relocatable to each other, the variable distance between the two frames precisely defines the length of the stretching gap.

"Ultimately, all the essential mechanical properties of the film in the machine and cross direction are determined by the length of the stretching gap and the stretching speed. Our system guarantees both maximum control of the film properties and very high production speeds," Robert Preuner, Head of R&D at SML, explains. With SML's new dual frame system, cleaning and service times are reduced significantly with a clear effect on line efficiency and profitability.

#### Extended film functionalities

SML's latest MDO generation is a further step towards an even larger variety of specific film functionalities at reduced costs.

- Mechanical functionalities, such as tensile strength, puncture resistance, stiffness, dead fold, easy one-directional tearing, machine direction stretch control and a high shrinkage in the machine direction
- Optical functionalities, customised to various requirements such as a high transparency and gloss, a low or high haze and light polarisation
- Barrier functionalities, for films of minimal thickness with the same oxygen and water barrier properties as thicker films

Generally, the production of down-gauging MDO film on SML's lines requires less raw materials, which has a positive effect on the carbon footprint as well as on overall production costs.

#### Easy to recycle stand-up pouches from MOPE film

An example for the innovative potential of MDO films are stand-up pouches: Usually, films for stand-up pouches have a thickness range from 25 to 80µm and are made of different types of polyolefins. SML's MDO units are able to manufacture thinner films from MOPE, which can replace BOPET or BOPP film on the outside of the pouches. On this way, pouches with a single material structure can be produced. On one hand, these thinner mono-material pouches are very easy to recycle. On the other hand, the raw material costs - and with it the general carbon footprint - are reduced clearly. Thicker MOPP films are used only for the sealing layer, providing straight tear properties when the stand-up pouches are opened.

#### Wide product range with new perspectives

The SML dual-frame design of SML's latest MDO generations offers stretching both according to the short gap and the long gap procedure. Thus these lines are not limited to process polyolefins, and the range of application for advanced MDO film is constantly growing together with the development of new formulations.

- Films for stand-up pouches
- PET films for twist film or lamination film
- MDO films for shrink-sleeves
- Label films
- Films for carrier handles
- Foamed MOPP films, i.e. for cable insulation tapes
- Functional breathable films from PE or PP for hygiene products

► SML Maschinengesellschaft mbH  
Gewerbepark Ost 32, 4846 Redlham, Austria  
[www.sml.at](http://www.sml.at)

# Strongly Positioned with Optimal Machine Technology for the Growth Market of PVC-O Pipes



PVC-O pipe extrusionsline - vacuum bath

*“We supply our customers with a plug & play solution immediately ready for use” is how Gernot Dorn, Director Sales PVC at battenfeld-cincinnati Austria GmbH, Vienna describes in a nutshell the decisive advantage of the machine manufacturer’s cooperation with the Spanish company Molecor Tecnologia SL, based in Loeches-Madrid. Molecor is not only a processor making PVC-O pipes in a wide range of different dimensions itself, but also a machine manufacturer offering customized complete lines to produce them jointly with battenfeld-cincinnati. Customers benefit from this vast pool of expert knowledge and are optimally prepared to meet the growth market of PVC-O pipes with the appropriate machine technology. After all, oriented PVC pipes are increasingly replacing metal and polyolefin pipes in the pressure pipe sector, due to their decisive advantages*



*Twin screw extruder twinEx for the extrusion of O-PVC pipes*

Since its foundation in 2006, Molecor has seen enormous growth and is known today as the world's largest and most experienced PVC-O pipe manufacturing companies with production plants in Spain, Malaysia, South America and South Africa. "Thanks to our enormous wealth of experience, we make top-quality pressure pipes with an unparalleled price/performance ratio," Dolores Herran, Business Development Director at Molecor, presents the company's special competence. PVC is an ideal raw material for pipe production, recommending itself by its range of good properties at a relatively favorable price. When compared with the competing metal pipe sector, plastic pipes score with corrosion resistance and easier laying; when compared with PE pipes, PVC pipes win by their about 15 to 20% lower material price.

A further special feature of PVC-O pipes is their profile of ideal mechanical attributes with higher free section for more flow transportation resulting from a special production method. This consists of two process steps: production of a thick-walled preliminary pipe on a standard PVC pipe extrusion line, and subsequent heating this proforma pipe and further form-

ing of the pipe by orientation in a special mold. While the length of the pipe remains unchanged, this leads to its external diameter being almost doubled, with a significant reduction of its wall thickness. During the orientation process, the polymer molecules orient themselves in the hoop direction, with the result of high mechanical properties: impact resistance, no crack propagations, fatigue resistance among others. When compared to conventional PVC-U pipes, PVC-O pipes come with up to 50% thinner wall thicknesses for the same pressure class. The resulting lighter weight per meter facilitates handling on building sites enormously. This equally applies to comparisons with metal or polyolefin pipes. These advantages are driving the increasing global demand for PVC-O pipes in all sectors of water management. Molecor currently operates itself seven extrusion lines from battenfeld-cincinnati at its main production plant in Loeches to produce PVC-O pipes with external diameters ranging from DN90 to DN1,200 mm. All of these lines are equipped with high-performance parallel twin screw extruders from the twinEX series, PVC-O spider pipe dies with internal cooling and all necessary

downstream components, such as vacuum bath, haul-off and cutting saw. Molecor manufactures itself and not only for its own production lines, the line components for the second process step, which include a heating station, the blowing station and a cooling unit. "Of course we make use of our own experience in pipe production for continuous optimization of our machine technology," Dolores Herran highlights a feature providing added value for customers.

battenfeld-cincinnati and Molecor have now sold jointly more than 15 lines for producing PVC-O pipes world-wide, to destinations such as India, Kazakstan, Malaysia, and Australia. "Our success proves us right: the ideally coordinated complete extrusion lines combined with Molecor technology offer pipe manufacturers a clear competitive edge," Gernot Dorn sums up.

**battenfeld-cincinnati Austria GmbH**  
(Vienna, Austria)  
[www.battenfeld-cincinnati.com](http://www.battenfeld-cincinnati.com)

**Molecor Tecnologia SL**  
(Loeches-Madrid, Spain)  
<https://molecor.com/en>

*Brückner Maschinenbau, based in Siegsdorf, Germany, is the world market leader for large production lines for the manufacture of a wide variety of flexible plastic films, used as high-quality packaging materials and in technical applications. In terms of incoming orders, the past fiscal year was the second most successful in the company's history. More than 45 lines sold by the end of 2020 mean an order intake of almost 800 million euros, a significant increase compared to the previous year*



*Highly efficient film stretching line*

# Desire for Hygiene and Food Safety Increases Worldwide Demand for Flexible Packaging Films

One reason for the very pleasing business development is certainly that topics such as hygiene and food safety have become much more important in the packaging sector worldwide – and particularly in Asia. In addition, food retailing and mail-order trade have recorded international growth. This also increased the demand for Brückner film stretching lines, on which the highest quality packaging films are produced, and also for the corresponding services.

The outlook for the next few years also gives cause for optimism. Stefan Neumann, Chief Financial Officer: "Our order backlog extends well into 2023. In addition, we are currently pleased about two major orders from China." With the long-standing customer Jiangsu Hengli New Materials, the quality leader in the polyester film industry in China, multiple contracts with a term of five years were

signed, with an order volume that significantly exceeds the average annual volume of Brückner Maschinenbau.

The complete package comprises dozens of BOPET lines for packaging films, optical and industrial films as well as ultra-thin specialty films and special BOPET thick film lines. The framework agreement covers a total of 15 different line types, including a very special laboratory line. In addition, one of the leading manufacturers of battery separator films, Shenzhen Senior Technology Material Co., Ltd., has now ordered eight further special lines from Brückner. Here, Brückner was able to convince with the latest technology, which will also be used in battery production in Europe in the future.

In any case, Brückner Maschinenbau is certain that, in addition to the booming packaging sector, technical films and their production lines are also on the rise. Future top-

ics here include not only battery separator films but also films for medical and high-temperature applications, solar panels or organic and printed electronics.

Fittingly the company from Siegsdorf recently received an award for its innovation management: Brückner Maschinenbau convinced in a scientific selection process for the innovation competition "TOP 100" and is now officially one of the 100 most innovative companies in the German medium-sized businesses.

When it comes to plastics and the environment, Brückner is convinced that the future will continue to belong to plastics if they are used and reused sustainably. Helmut Huber, COO Sales & Project Management: "As part of a circular economy, the undeniable advantages of plastic can be combined absolutely well with the sustainability goals of a modern society. We are working intensively to ensure that films can be produced on our machines with



Brückner company premises in Siegsdorf



Stefan Neumann,  
Chief Financial  
Officer

the lowest possible use of resources and the highest possible recyclability." In doing so, Brückner also cooperates in various consortia with partners along the entire value chain, from raw material manufacturers to brand owners. Examples of this are the R-Cycle or PrintCYC initiatives.

**Plant commissioning and service even during pandemics**

To ensure that the lines sold are also installed and commissioned on schedule all over the world, Brückner coordinates all trips as part of a special Corona crisis management system. Helmut Huber: "In close coordination with our company doctor and our teams in the respective countries, we make sure that all rules and precautionary measures are observed: before, during and after the trip. Employee safety always takes precedence over short-term business success. Nevertheless, traveling in these times demands a lot from our employees – keyword quarantine. We are therefore more than grateful that the willingness of our colleagues to travel abroad remains high – this is extremely appreciated by our customers."

The service provider for film stretching technology, Brückner Servtec, also based in Siegsdorf, was even able to increase its order intake by an impressive 60% in orders for line upgrades. Overall, incoming orders are at a record level of around 70 million euros, again a significant increase on the previous year. This naturally has a positive impact on sales in 2021, for which a record figure of around 71 million euros is expected.

A major global customer has also recently placed extensive modernization orders with Brückner Servtec, to significantly increase the sustainability of production. This involves a total of four production lines in the packaging film sector, spread over three continents. In addition, the plant modernization will ensure the processing of raw materials, enabling a circular economy.



Helmut Huber,  
COO Sales & Project  
Management

# Fast and Reproducible Sample Inspection of Plastic Pellets

SORTCO relies on SIKORA's inspection and analysis device PURITY CONCEPT V for contract sorting

*SORTCO GmbH & Co KG is a specialist for optical and mechanical sorting of shape and color deviations in plastic pellets. Further focal points are dust removal and metal separation of plastic raw materials. In March 2021, the company opened a new, state-of-the-art sorting service center in Niederzissen/Rhineland-Palatinate, Germany, where both optically demanding technical plastics and standard plastics are cleaned. The PURITY CONCEPT V, an optical inspection and analysis system from SIKORA, is used for final sample inspection after the sorting process*

The highest purity of engineering plastics is a decisive feature for the quality of the end products, especially for use in the automotive, aerospace as well as medical and information technology industries. The requirements for the purity of the materials are correspondingly high. Since 2015, SORTCO has been active as a contract



Picture 1: Hilger Groß, Head of Sales and QM at SORTCO, presents the PURITY CONCEPT V from SIKORA for inspection and analysis of plastic pellets

sorter and professionally prepares plastic pellets according to customer requirements. "The goal of all sorting orders is a high-purity product," says Hilger Groß, Head of Sales & QM at SORTCO, adding, "We aim to supply our customers with material which is so clean that it is at least equivalent to virgin material. Therefore, our sorting includes a 100 % inspection of all individual pellets."

The sorting is carried out by means of different inspection methods. For the optical inline inspection and au-

tomatic sorting, two PURITY SCANNER ADVANCED from SIKORA are used at SORTCO. Following the sorting, the random sample inspection of the pellets for final quality control is performed with SIKORA's laboratory testing system PURITY CONCEPT V (Picture 1). "With the system, we inspect a pellet quantity defined with the customer and agree on the inspection frequency. For 1,000 kg of pellets, for example, between 1 and 3 samples of approximately 100 g each are inspected." The test mate-

rial is distributed on the sample tray, automatically guided through the inspection area and inspected by a camera within a few seconds. A projector marks contaminated material in color directly on the sample tray. At the same time, the contaminated material is displayed and marked on the monitor, indicating the size of the contamination. Individual contaminated pellets can be selected and magnified. On the sample tray, these are simultaneously visualized optically by crosshairs (Picture 2). There are several inspection methods for the random inspection of plastic pellets on the market. However, according to SORTCO, the inspection and analysis system from SIKORA has proven to be the leader in this field due to its functionality, reliability and speed. "Only with SIKORA, the test material lies on a sample tray without any movement. Thus, the analysis image shows an unsurpassed image quality. With alternative systems, the specimen is in motion, whereby blurring of the image makes an unambiguous evaluation more difficult," explains Groß and continues, "With the PURITY CONCEPT V, we can make reliable statements about the product quality very quickly, very easily and,

above all, reproducibly. A clear competitive advantage is the projector. All detected contamination is precisely marked via a light spot or colored crosshairs and can be easily removed from the sample tray. These can be further examined and analyzed to draw a conclusion about the cause of the defect." Clear assignment of contamination and follow-up checks are possible at any time and do not have to be carried out manually by the operator. Groß also cites the clearly structured test report as a quality inspection certificate for the customer that complies with the requirements of ISO 9001:2015, as well as the testing speed of only about 15 seconds per sample inspection as clear advantages of the system. "Including all handling, we have a representative test result within 2 minutes. That is unbeatable on the market."

There is hardly any type of contamination, that the system cannot not detect. The PURITY CONCEPT V is far superior than the human eye. Humans initially recognize only large contrasts; smaller and lighter defects are overlooked. The system immediately identifies all color deviations from a size of 50 µm. These are often burns of the polymer in varying

intensity, the so-called black specks, specks, burns or also brown or yellow specks. The size and number of all colored defects and contamination in the pellets are recorded. An unlimited number of individual tests or alternatively serial tests can be performed. Up to 100 individual tests can be combined into one overall result. The test results are documented and automatically made available to the customer together with the sorting results and the quantity balance after completion of the order. Usually, test samples are stored for 12 months. However, the test data is also available at SORTCO beyond this period so that customers can refer to it, for example, in the event of a complaint from the end user.

Innovative and reliable inspection systems for purity testing are essential for sorting at SORTCO. Inspection and sorting systems will continue to gain importance in the industry in the future. According to Groß, this is due to the increasing visual demands placed on products, but also to the high costs associated with machine downtime and repairs to hot runner systems and injection molds. At the same time, sorting reduces injection molding waste, which, in addition to the economic benefits, also helps protecting the environment. "With the opening of our sorting service center in Niederrissen, we will install more inspection and sorting machines," Gross reveals. The creation of new sorting capacities is only one aspect of this. In the future, the main focus will be to reliably detect defects from a minimum edge length of 50 µm and to separate them in the best possible way. "With SIKORA, we have found a partner whose systems meet these requirements not only for the random sample inspection, but also for the sorting."

Picture 2: Detected contamination is highlighted in color on the sample tray as well as in the software, for an easy extraction

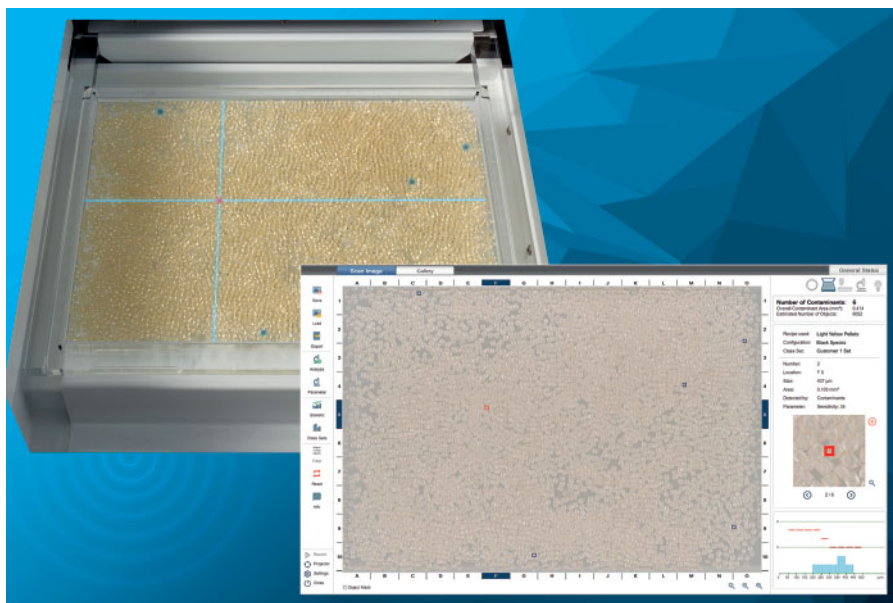

*How to handle plastic waste and the reduction of CO<sub>2</sub> emissions are two of the most important topics our society will be dealing with for the next decades to come. MAAG Group is proud to have supplied its latest state of the art x<sup>6</sup> class melt pump technology for the first fully integrated sugar-to-PLA (polylactic acid) plant in China. The plant is based on a Sulzer technology and key equipment for converting lactide into PLA. The lactic acid and lactide production is made from sugars (in this case won out of locally grown corn). Not only is the plant reducing the carbon footprint because of using plant-based resources instead of hydrocarbons, by using MAAG Group's x<sup>6</sup> class gear pump technology, the specific energy requirement is optimized furthermore*



*Bioplastic PLA pilot plant (Source: Sulzer)*

## Melt Pump Technology for Production of Bioplastic PLA

MAAG Group's pumps are used in the polymerization reaction stage, making sure that the efficient Sulzer SMRTM reactors are working smoothly in all operating conditions. But they are also used in the devolatilization stage, where, a minimum level is required when unreacted lactide is removed from the PLA melt to achieve a good product quality. In the last stage, MAAG Group's melt pumps are used to build up the necessary pressure to process the melt through the downstream equipment, up to the underwater pelletizer.

MAAG Group's x<sup>6</sup> class melt pump technology key feature is the reduced back-flow to lower the energy consumption. The x<sup>6</sup> class melt pump helps to save

up to 50 % energy and reduces material recirculation in the pump of about 50 %.

While the reduction of 50% of energy is possible in exceptional cases and in extreme operating conditions only, the trend is true for all the applications when MAAG Group's x<sup>6</sup> class technology is used. With the energy saving, also the CO<sub>2</sub> footprint is reduced. But x<sup>6</sup> class pumps offer far more than that. The high efficiency of the pumps is offering a wider operating range as compared to other state of the art technologies. It allows for example that low viscous pre-polymer can safely be processed through the Sulzer plug flow reactor when the polymer conversion is pro-



*Swiss quality melt pump from MAAG Group*

gressing and the viscosity is continuously increasing in the same. The high efficiency of the x<sup>6</sup> class technology keeps the bearing temperatures lower than in former pump technologies, allowing always a stable film of polymer, lubricating the turning shaft. The favorable shaft geometry, where the length over center distance ratio has increased, allows the operation of extraction pumps at a lower fill level than it was ever possible before at a given connection size to the vessel. Only like this the PLA can fully be concentrated. But also, the reliability has increased. Not only are the bearing surfaces almost 30% bigger, providing a better cushioning, but the pump is also working with bigger gaps, allowing potentially small foreign particles entering the system to pass the pump easier without damaging it. The x<sup>6</sup> class pumps are the perfect fit for a modern, sustainable plant producing bio-plastics.

*MAAG Group vacorex® x<sup>6</sup> class polymer extraction gear pump ideally fulfills modern polymer production processes which require polymer pumps that can discharge at high pressure despite very low fill level and high vacuum conditions in the reactor/ devolatilization vessel*

*Polymer processes require booster pumps and polymer metering pumps that gently process both high and low viscosity plastic melt through the polymer processing system*

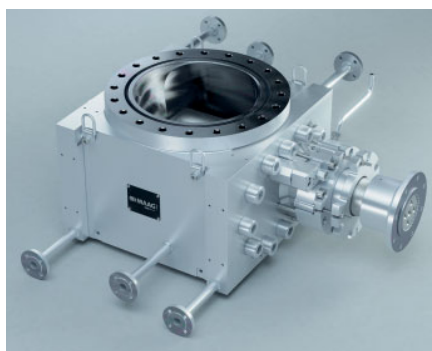



# Extrusion Lines for Pipes Renewed

## State-of-the-art heads and increased output

*The global demand for plastic pipes has grown exponentially and, over the next few years, is set to increase for a large variety of applications: from water and gas supply networks, rainwater drainage and the transport of various fluids to energy supply systems and sprinkler systems. In this context, Bausano announces that it has completely revamped its ranges for the extrusion of soft and rigid, transparent, supercharged or press-filled PVC, PP and PE pipes in order to meet the ever-increasing demands of manufacturers for melt homogeneity, flexible processes, maximised output and reduced energy consumption*

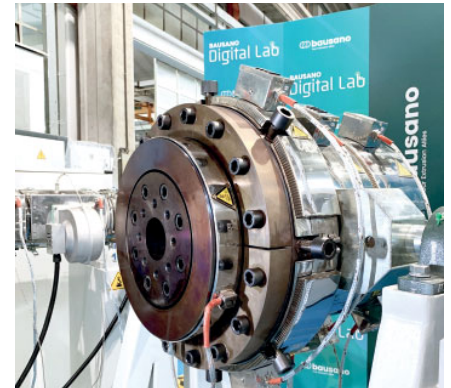

The main innovations include the launch of a new generation of extrusion heads. In particular Bausano offers a range of models for the manufacture of PVC pipes, either double (up to 110 mm) or single output (from 10 to 800 mm), for a maximum production capacity of 2,000 kg/h. As for the extrusion of polyolefin (PO) pipes, Bausano's technology is designed to ensure high hourly throughput with reduced energy consumption. The heads stand out for their compact design for monolayer or multilayer production: radial spiral, ensuring better melt distribution within a smaller volume and with reduced pressure build-up, or helical spiral. These are modular systems where the number of layers can be easily increased by adding special modules. A combination

of both designs, helical and radial, is also possible depending on the structure of the pipe, its materials and its dimensions. The offer also includes an internal air pipe cooling system, which cools the pipes more quickly, thus improving their quality while taking up less space when installing the line.

Bausano's extruders also include the innovative Smart Energy System for heating the cylinder through an electromagnetic field, thus saving up to 35% on energy.

The Bausano lines also include new end-of-line accessories such as cooling and calibration benches made of stainless steel, which are crucial to the success of the whole extrusion process, with pipes that are cut to size and have a flawless surface. Specifically, the tank for PVC pipes allows for quick and accurate positioning during processing due to the three axes, which can be easily adjusted, and the motor-driven longitudinal movement. In the case of PO pipes, the benches are designed to calibrate and cool a wide range of diameters between 5 and 1600 mm. Last but not least, a dual chamber configuration is available for both applications, with temperature and water level control, which allows different vacuum conditions to be created as required.

"We made the decision to upgrade our extrusion lines for PVC, PE and PP pipes as we wanted to meet the demands of manufacturers that always need to ensure that their supplies are in compliance with technical requirements, without compromising on efficiency and performance," says Clemente Bausano, Vice President of Bausano.

**Bausano & Figli Spa**  
C.so Indipendenza 111, 10086 Rivarolo Canavese (TO), Italy  
[www.bausano.com](http://www.bausano.com)



# Shape your Pipes, Shape your Future and Go Green

*The need for innovative green technology in the plastic pipe production industry capable of guaranteeing high performance, process flexibility and ease of use while allowing reduced energy consumption, has become increasingly pressing and has had a marked influence on the design of various types of extrusion line machinery, including bellling machines*



Sica, an Italian plastic pipe machinery manufacturer, has definitely gone green with its machinery to save energy, material and process costs. All the machines in the line, from haul-off to packaging, have their specific "green" features.

Regarding bellling machines, an example is the use of short-wave ovens that are active only during the heating phase and for the time needed to reach the final set temperature of

the material, thus reducing energy consumption and avoiding scrap material.

Another aspect of the new bellling process is the electromechanically operated socket forming unit in place of conventional hydraulic and pneumatic solutions. The decision to utilize electrical technology produced several benefits: highly dynamic operation, low

noise levels, exceptional precision and repeatability of positioning, total real-time control of process parameters in terms of working strokes and speeds, and no contaminating fluids emission. These are important advantages especially for bellling machines for small dimension pipes that were originally pneumatically operated.

All Sica new bellling machines like Unibell and Multibell for PVC pipes, or Everbell for PP pipes are highly productive (many models process more than one pipe simultaneously) and low consumption.

Sica's decision to invest in these new technologies encourages not only a regard for the environment, it also leads to a reduction of pipe production costs, thus allowing faster returns on capital expenditures.



# Physical Foaming to In-House Extruder Test Line Added

*MEAF Machines has added a PROMIX physical foaming installation to its in-house extruder test and demonstration line. Since mid-May this allows customers to get hands-on experience with this material saving equipment while using their own polymer grades in the process. The potential savings from the PROMIX equipment come in addition to the benefits of the MEAF extruders, that are already among the best for energy efficiency and economy*

"Physical foaming offers a significant material saving potentials for extrusion processes," says Roald de Bruijne, Sales Manager at MEAF. "PROMIX are setting new standards in the production of microcellular foam products with a very homogeneous cell structure and unprecedented process stability, while using eco-friendly CO<sub>2</sub> and N<sub>2</sub> blowing agents. Depending on the application, density reductions of 5 to more than 30 % can be achieved. The resulting material saving will not only benefit the plastic processors, but also their customers and the environment."

"When opting for a new type of raw material, material mixture or a new machine supplier, it is always helpful to be able run a test before deciding the best way forward," adds Roald. "It is like taking a test drive when you are looking to buy a new car. With MEAF's new in-house

*The micro foam process offers excellent rigidity, insulation and insensitivity to scratch marks, and results in the lowest energy consumption per kg in the industry (Source: MEAF)*

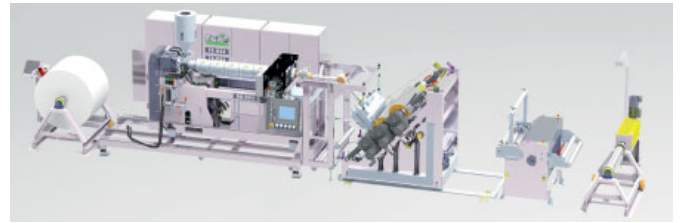

*MEAF Machines has added a PROMIX physical foaming installation to its in-house extruder test and demonstration line. As of mid-May this will allow customers to get hands-on experience with this material saving equipment while using their own polymer grades in the process (Source: MEAF)*

test & demonstration line, we provide this capability to our customers. Our extrusion line has been designed and build to accommodate the latest technologies, such as physical foaming, and a wide variety of materials for our customers' packaging needs, be it PET, PE, GPPS, PS, PP, PLA or biodegradable grades."

For any sheet or film extrusion, the largest contribution to the production costs are by far raw materials, often surpassing 70 % of the total production expenses, usually followed by energy consumption. Therefore every manufacturer is looking to reduce its overall production costs by reducing the raw material expenses. One approach is to increase the amount of recycled material, regrind skeletal waste or bottle-flakes in the case of PET film extrusion, or the utilisation of filler components such as CaCO<sub>3</sub>.

"To reduce the overall raw material costs further, even more needs to be done," explains Roald. "This is where MEAF's sheet extrusion line in combination with PROMIX physical foaming comes in. Not only will it typically reduce the cost of plastic raw material by 20% compared to conventional packaging, the overall weight reduction of 10 to 30% has further benefits, as some countries use this a basis for packaging taxes. In addition packaging can be made 100% recyclable, while also allowing the utilization of recycled raw material, also foamed."

The micro foam process offers excellent rigidity, insulation and insensitivity to scratch marks, and results in the lowest energy consumption per kg in the industry. With the set up processors can work with multiple types of materials in one extruder, such as PP, PS, PET, PE, GPPS and PLA. Both foamed and non-foamed sheets can be produced on the same line, even allowing for multilayer A/B/A sheet, where the A-layer is a solid non-foamed layer, and the B-layer is of a foamed material.

MEAF Machines B.V.  
Industrieweg 10, 4401 LB Yerseke, The Netherlands  
[www.meaf.com](http://www.meaf.com)

Although synthetic lawn had been introduced in American baseball stadiums already at the end of the 1960s, it only became an accepted alternative to the high-maintenance natural lawn at the turn of the millennium. But after 12 to 15 years of use, up to 5,000 artificial turf sports fields are currently due for renovation in Germany alone. This raises the question of the best possible disposal. Up-to-date the only serious answer is: "Recycling". The Austrian extrusion and recycling technology company MAS offers innovative system technology for converting old and worn artificial grass efficiently and cost-effectively into high-quality plastic granulate

Picture 1: Schematic structure of a typical artificial grass system (Picture: Poytan)

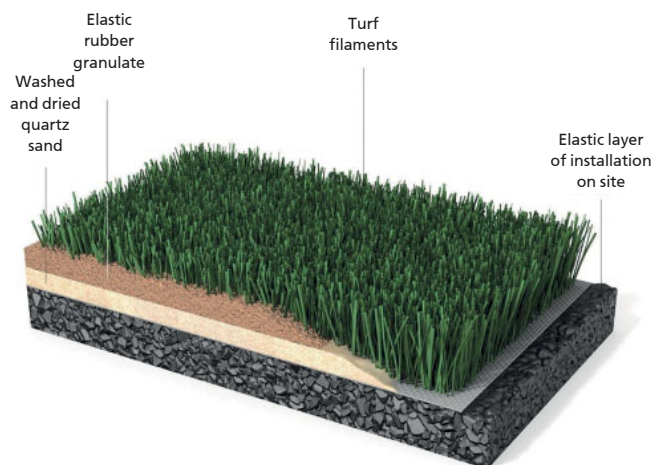

## New Life for Worn Artificial Grass

The Austrian mechanical engineering company "MAS-Maschinen- und Anlagenbau Schulz GmbH" in Linz / Pucking specializes in innovative ex-

trusion and recycling solutions. Its core competencies are plastics recycling plants, like the DRD (Double Rotor Disc System) dry cleaners for

the waterless separation of granular impurities from plastic flakes and the conical twin-screw extruders with co-rotating screws, which plasticize particularly homogeneously and gently. In addition, the MAS product portfolio includes also disc filter systems for highly efficient continuous melt filtration. These are the basis for integrated recycling systems, such as those to be used for the recycling of worn-out artificial lawns.

Picture 2: Removed and pre-cleaned artificial grass tracks (Photo: FIFA / Re-Match)



### Artificial grass is the resilient alternative to natural lawn

If lawn sports fields are to be used all year round and to have uniform characteristics of use and visually appealing qualities regardless of environmental influences, there is no way around synthetic lawn. Especially if, in addition to a high level of use, increasing climatic extremes, such as long periods of dryness or heavy rain events, affect a natural lawn. The



Picture 3:  
Processing  
stage 1:  
Shredded worn  
artificial grass  
(Photo: MAS)

artificial grass its premiere in 1966 on the playing ground of the Astro-Dome in Houston. It was a carpet-like flooring, made from polyamide yarns. But as it was laid without a shock-absorbing substructure or filling material it posed a risk of injury for the players. In the 1980s an evolutionary version was introduced with the grass blades made from polypropylene strips and sand as the filler material. This reduces the injury risk, but there was still a lack of impact damping properties. The next evolutionary stage in the 1990s combined PP and HDPE grass mats with sand and rubber granulate fillings, which offered the desired damping properties and made the UEFA and FIFA approving synthetic lawn systems for football stadiums. At the beginning

of the 2000s, the 4th generation of artificial lawn systems came onto the market. Their distinguishing feature is the combination of stiff, upright and soft, curled PE-grass blades on a PP base fabric. The stalks and carrier fabric are joined together on a so-called tufting machine. There, the stalks are fed from rolls as yarn, pierced into the carrier fabric and then usually cut to a length of 42 mm. The blades are permanently fixed by coating the back of the fabric with a latex/PU-adhesive. After laying, the artificial grass is filled up to a height of 30 mm with sand and shock-absorbing rubber granulate. This combination comes very close to a natural turf without showing its sensitivity to mechanical and climatic stresses (Picture 1).

### Innovative recycling methods turn artificial grass sustainable

Experience has shown that an artificial grass system can be in intense use for 12 to 15 years before it is due for renewal. And there is the question regarding the best possible disposal. As landfilling or thermal disposal in waste incineration are no longer accepted options due to the sharp increase in quantities there is no getting around recycling. Especially since better and more cost-effective methods are available to recycle almost 100 percent of the plastic and single-material systems are in the pipeline. The later in order to improve recyclability through the manufacture of the blades of the synthetic grass and the base fabric from the same material (PE) and to replace the method of connection by gluing by means of thermo-fixation. This will significantly simplify the technical efforts required for recycling. But as the single-material systems are just to be introduced they will be due for renewal only in 12 to 15 years. But until then, also conventional synthetic lawn can be recycled into valuable secondary raw materials.

### The MAS-Recycling-Options

The renewal begins with the removal of the worn lawns (Picture 2). But before these can be removed and rolled up, the filling material (rubber granulate and sand) is to be vacuumed off. The better and more

### Cleaning principle

- Cleaning principle**  
**Material discharge**  
**Material:**  
 - Dry\* (residual moisture up to < 1%)  
 - Clean\* (residual moisture up to < 0,5%)
- ↑ Scaper  
 ● Material  
 ● Dust  
 ● Heavy component
- Material intake**  
 - Material  
 - Contamination (earth, sand) up to 30%  
 - Plant residuals  
 - Stones, metal fragments, glass  
 - Moisture up to 25%

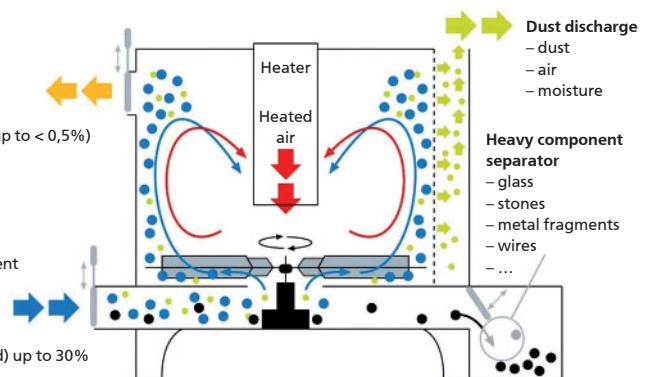

Picture 4: The functional principle of the MAS dry cleaning system: The film flakes are dried in turbulent hot air. The decreasing moisture causes the debonding of granular and dusty substances, which are separated tangentially by centrifugal force (Picture: MAS)

Picture 5: Detail view through a tangential sieve into the centrifuge chamber of the DRD 26 system. Below the double rotor system with 12 rotor blades with 12 rotor blades, above the heating register housing (Photo: Author)



contaminants and moisture adhering to the fiber material is efficiently separated. It is basically a centrifuge with a double rotor system running inside. Double because the rotor disc has differently shaped rotor blades on the bottom and top (= patented double rotor disc system). The system is operated in batches. The underside of the rotor sucks the shredded material out of a buffer container and transports it into the centrifuge. Gravity ensures that larger and heavy contaminants, such as metal parts, stones, etc. are not transported into the process chamber at all, but are separated into an upstream heavy material separator (Picture 4). Subsequent, the pre-cleaned material is forced into a turbulent hot air circuit by the rotor. The warm air absorbs the moisture and transfers it off in exchange with the outside air. The warm air is generated via a central heating element register. In addition, the declining moisture content and the friction between the plastic particles created by the turbulence cause residual dirt to be separated off tangentially by centrifugal force via lateral separation sieves (Picture 5). The cleaned plastic batch is then discharged at periodic intervals by centrifugal force after opening a pneumatic flap and fed to a material silo.

thoroughly these extraneous materials can be separated, the easier is the further processing of the old lawn. The next recycling step is the shredding down to particles 10 to 40 mm in length with a bulk density (uncompacted) of approx. 50 to 100 g/l (Picture 3).

The shredded material consists of: approx. 40% PE (the actual grass-blades)

approx. 20% PP (base fabric)

approx. 40% latex/natural rubber or PU (backing on the base fabric)

It contains up to 15 percent by volume of impurities, consisting of:

> up to 8% extraneous materials (dust, sand, soil)

> up to 1% rubber (old tire granulate) or EPDM from approx. 2 mm down to dust,

> 3 - 5% moisture

Material tests have shown that the MAS-system-technology is capable to process this PE/PP-fiber-mixture

into a high-quality plastic granulate. Their basic processing component is the DRD (Double Rotary Disc) dry cleaner-unit.

#### Processing stage one: dry cleaning – simple but effective

The shredded material is fed to the DRD (Double Rotary Disc) dry cleaner. In it the majority of all granular

#### Processing stage two: plasticizing, filtering and degassing

The plastic fraction fed from the DRD-dry-cleaner via the buffer

Picture 6: MAS cascade extrusion line, consisting of a conical MAS twin-screw extruder, a CDF-disk-melt-filter and a MAS single-screw-extruder with degassing unit (Picture: MAS)

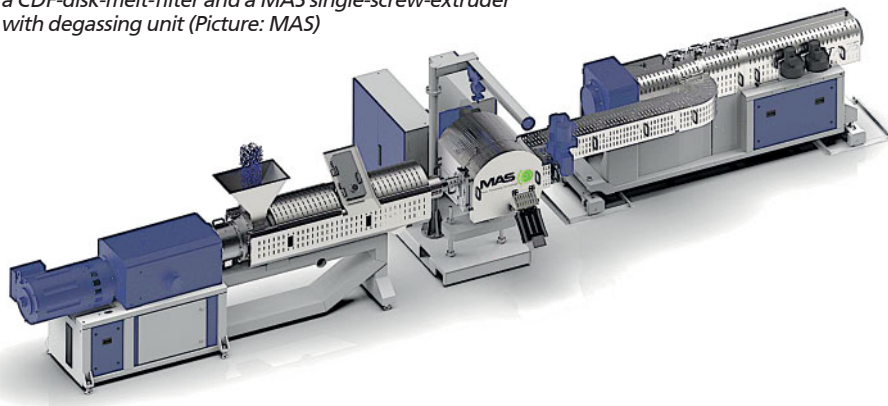

silo to the extruder consists of the above-mentioned components PE (grass blades), PP (base fabric) and latex/PU (adhesive layer), as well as marginal residual amounts of rubber granulate.

For the further processing of this input material MAS has developed an extrusion cascade consisting of a conical twin-screw extruder with degassing unit, a subsequent continuous melt filter, a single-screw extruder and a granulating station (Picture 6). The advantage of the conical MAS-extruder is the system-specific large cross-section of the feed opening. This makes it particularly suitable for materials with a low bulk density, such as synthetic lawn fiber flakes.

The co-rotating MAS-twin-screw-principle is characterized by a plasticization at a comparatively lower mean pressure and level of shear and a highly uniform melt flow with excellent homogenization. The latter is particularly important for recycling applications. This is because it is the prerequisite for the release of undesired plastic fractions in gas form and filtering.

The plastic melt is conveyed from the MAS extruder through a CDF(Continuous Disc Filter)-melt-filter-unit, developed and patented by



Picture 8: End product of the artificial grass recycling - a high-quality raw material for new quality products (Photo: MAS)

MAS for recycling applications. The core component of all CDF-filters is a filtration disk rotating in the incoming melt flow. It holds back the impurities, in the specific case remaining rubber particles or unmolten plastic particles. The filter discs are made of hardened steel and, depending on the application, are available with filtration fineness from 90 µm to 1,000 µm. The impurities are wiped off from the rotating filter-disc by a stationary scraper in the filter housing. From there a screw conveyor conveys them together with a minimum amount of plastic to the outside. The melt-filter-series is

matched to the MAS-extruders and for throughputs of up to 2 t/h.

From the CDF filter, the melt flows via a special distributor block into the subsequent single-screw extruder, equipped with a second degassing-station. This offers a procedural innovation. It is the patented division of the melt flow into a series of individual flows (Picture 7). This division ensures that the pre-cleaned polymer-mixture can consequently be degassed in the single-screw-extruder more efficiently due to the increased melt surface. From the single-screw extruder, the melt is either fed to a pelletizer or processed further in-line.

The outcome is a high-quality-PE/PP-granulate for a variety of different quality products, e.g. films, as could be documented by a series of plasticizing tests (Picture 8). This opens up the potential for one or more "reincarnations" of worn artificial grass in other applications or products.

Picture 7: Section through the "multi-channel melt feed block", in which the melt flow coming from the melt filter is divided into individual melt flows (Picture: MAS)

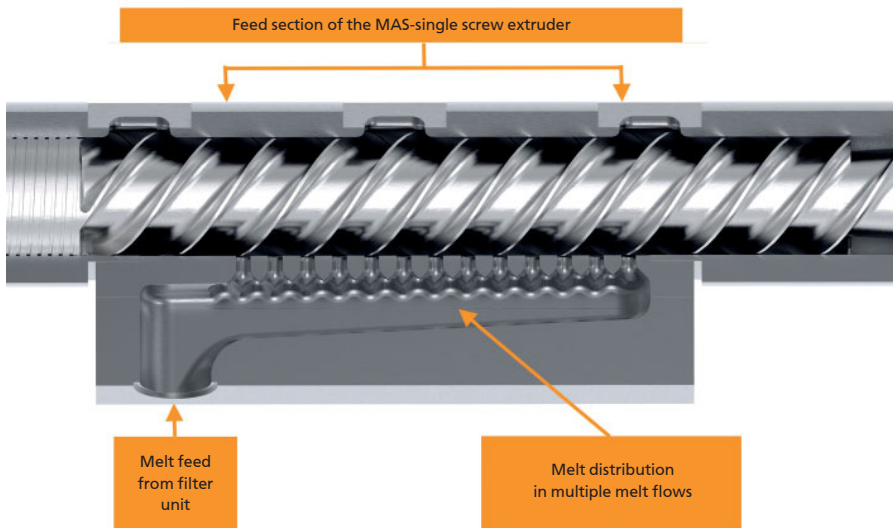

Author:

Reinhard Bauer - TECHNOKOMM  
office@technokomm.at

MAS Maschinen- und Anlagenbau  
Schulz GmbH  
A-4055 Pucking, Austria  
www.mas-austria.com

# PCR in Cosmetic Packaging?

## *It's all a Question of Technology*

*The blow molding specialist W. MÜLLER has tested two methods for the use of post-consumer recyclates (PCR) in packaging. In the first examined variant, the PCR layer is surrounded by two layers of new material, the second variant is shielded with an internal plasma coating. Both variants had significantly lower migration values than hollow bodies made of pure PCR*

W. MÜLLER has many years of experience with the use of PCR for the production of hollow articles in the blow molding process. With the in-house ReCo<sub>3</sub> called 3-layer-co-extrusion system, bottles can be produced consisting of a PCR layer that is surrounded inside and outside by a virgin layer. In this way, virgin material can be replaced by PCR in processing, and still unwanted migration from the PCR can be reduced.

The company has tested how the migration behavior of round bottles with a volume of 1l from 100% recyclate differs from those produced with the ReCo<sub>3</sub> process. Two certified PCR types were selected (one was Recylen BM 948-30, sponsored by OPG Holding, Teningen) and one bottle of the pure material and one with a virgin layer in the outer layer were produced. At the SGS INSTITUT FRESENIUS, Taunusstein/Germany, vari-

ous migration tests were carried out, such as global migration and screening for potentially migratable impurities, reaction and degradation products (NIAS). Global migration was tested in accordance with DIN EN 1186 2002-07 and the results were in all cases below the legal requirement of Regulation (EU) No 10/2011 of 10 mg/dm<sup>2</sup>.

However, W. MÜLLER was able to show on the basis of the tests that the ReCo<sub>3</sub> bottles show a lower global migration compared to the pure recyclate bottles. This is also confirmed by a significant reduction in the number and concentrations of migration-capable NIAS.

In order to increase the recyclate content in such three-layer systems, the surrounding layers must be as thin and yet stable as possible. In addition to plastic layers, plasma coatings are therefore also suitable for the purpose of shield-

ing. In a second series of experiments, FABES Forschungs-GmbH, Munich/Germany, investigated how a CHF layer (CHF stands for carbon – C, hydrogen – H and fluorine – F) applied by the Belgian company Delta Engineering on the inside affects migration behavior. With the help of plasma, a barrier is created in the process. These bottles were made from Systalen 70000 na 002 HDPE, which was sponsored by "Der Grüne Punkt".

The tests showed that the coating drastically reduces migration. While 76 substances were detected on the uncoated bottle, the CHF-coated bottle had only 5. Since fluorine is used for the CHF coating, additional tests have been carried out with the coated bottle to ensure that no residues have been formed. As a result, no substances can be detected. The bottles are therefore also compliant for direct contact with "Rinse-Off" products such as shower gel.

The involved research institutes point out that users have to carry out their own risk assessment, as the results depend, for example, on the size of the bottle and the intended use, and the starting materials could change from batch to batch.

Managing Director Christian Müller said: "We were able to show with the tests that the use of plastic recyclates for packaging of sensitive products is possible. With the right technology, there is no demonstrable risk of migration from the recyclate to the filling material. The findings confirm that our proven ReCo<sub>3</sub> process fully meets these requirements. With the plasma coating we have tested another possibility of shielding. The results have encouraged us to offer this technology as a supplement in the future if customers are interested. Together with our partner Delta Engineering, we want to make it easier for our customers to use recyclates."

*For the test series, bottles were made of pure PCR (right), as well as bottles with a layer of virgin material inside and outside (All photos: W. MÜLLER)*



*The two bottles for the second series of tests are made entirely of PCR. The bottle on the right was provided with a CHF coating from Delta Engineering*



*In the cross-section of a bottle made with ReCo<sub>3</sub>, the two outer layers of virgin material as well as the inner PCR layer are visible*



W. MÜLLER GmbH  
Am Senkelsgraben 20,  
53842 Troisdorf-Spich, Deutschland  
[www.w-mueller-gmbh.de](http://www.w-mueller-gmbh.de)





## Web conference

December 8, 2021 • Start: 10.00 CET

[lab.extrusion-info.com](http://lab.extrusion-info.com)

The official language  
of the conference is English

# Laboratory & quality control in plastics processing

- laboratory equipment
- quality control of input raw materials
- quality control of finished products
- analytical equipment
- measuring equipment
- pilot and test lines
- desktop mini IMMs and mini extruders
- laboratory mixers and compounders
- laboratory and processing simulation software
- metrology and equipment verification
- laboratory analysis services
- formulation development services
- certification services
- external engineering and research services
- R&D in the enterprise

Developed by:

**VM VERLAG**  
Cologne/Germany

**EXTRUSION**

**EXTRUSION**  
INTERNATIONAL  
WORLDWIDE

**ЭКСТРУЗИЯ**  
EXTRUSION RUSSIAN EDITION

**挤塑** EXTRUSION  
ASIA EDITION

**smart.molding**  
international



Contact: Alla Kravets • Tel.: +49 2233 949 87 93 • [a.kravets@vm-verlag.com](mailto:a.kravets@vm-verlag.com)

# EXTRUSION

EXPERT MAGAZINE ON PLASTICS EXTRUSION

The only technical magazine worldwide exclusively for the sectors:

- Material Preparation
- Compounding
- Extrusion
- Recycling
- Calendering
- Thermoforming
- Welding
- Finishing of Plastics and Elastomers



**Extrusion** (German)

**Extrusion International** (English)

**Extrusion International USA** (English)

**Extrusion Russia Edition** (Russian)

**Extrusion Asia Edition** (Mandarin/English)

The only plastics trade magazine for Asia, published from Germany

8 issues a year

6 issues a year

6 issues a year

4 issues a year

2 issues a year

**SMART  
EXTRUSION**

All editions available for free:

[www.smart-extrusion.com](http://www.smart-extrusion.com)

**VA** Verlag GmbH Cologne/Germany

