

05/2019

VMA VERLAG  
Cologne /Germany



# EXTRUSION INTERNATIONAL

USA

## Visions become true.



### **BREYER OptiFlex**

Extrusion lines for the production of high-quality film for sophisticated visual and functional applications.



**INNOVATIVE SOLUTIONS**  
Visit us at K2019, Düsseldorf, Germany  
16 – 23 October 2019 · Hall 16/C18

# BREYER

*extrusion lines*

[www.breyer-extr.com](http://www.breyer-extr.com)

## Profile stacking machine PRO

INNOVATION



### Profile length measurement during extrusion

Using special sensors the length of individual profiles can be detected before the formation of a profile layer to stack. The measured length can be used for checking and correcting the cutting unit of the extrusion line or for documentation (quality assurance) of the produced profile lengths.

### Weight determination during extrusion

Special weighing units can be used to weigh individual profiles before forming a profile layer. The determined weight can be used to optimize the extrusion process.

### Paper / Foil or Strip laying

By a paper / foil laying unit the profile stacking machines are capable to provide a paper or foil layer between stacked profile layers.

**NEW:** Additional to this feature plastic strips for the further stabilization of the profile layers in the transportation cassette can be provided.

The strips are positioned by a special device in defined positions on the profile layer already stacked. The next profile layer will be stacked on these strips then.

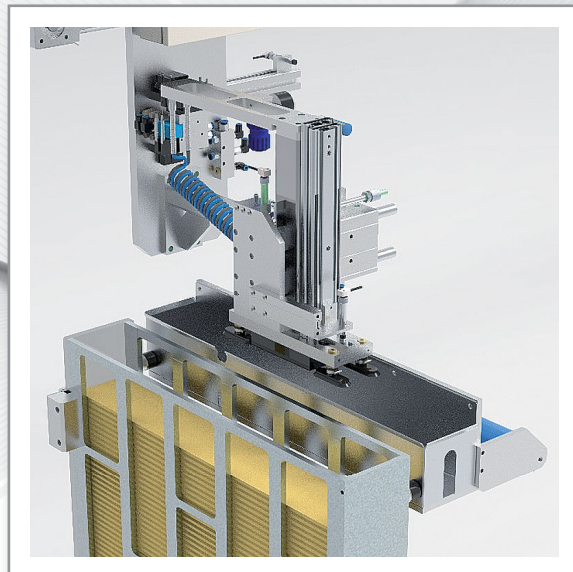
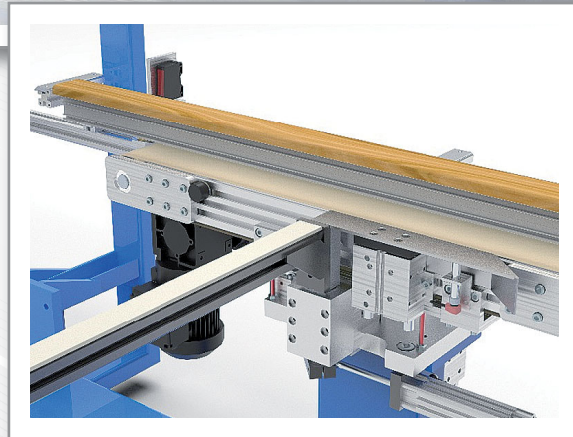

Made in  
Germany

## Laminating foil cutting unit

**INNOVATION**



### Foil cutting for laminating lines

For the offline lamination of profiles single profile sections are provided to the laminating line **end to end** and are laminated with foil continuously.

After the lamination process the laminating foil has to be cut to separate the profiles again.

The **laminating foil cutting unit** detects the profile ends, makes a gap in between the ends and cuts the laminating foil automatically.

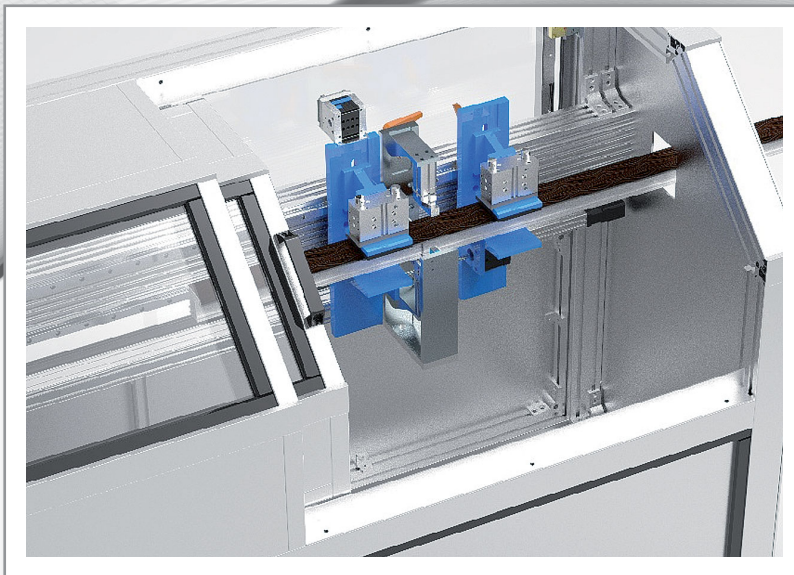

### Advantages of the laminating foil cutting unit

- No damage of the profiles when cutting the laminating foil.
- No interference of the cutting process into the laminating process.
- No danger to employees due to manual cutting.

„**STEIN BLUE-LINE – for a sustainable future**“ stands for sustainable and energy-efficient equipment. Almost 100% domestic production and the high degree of manufacturing penetration guarantee compliance with even the most stringent of demands.



**STEIN Maschinenbau  
GmbH & Co. KG**

Wartbachstr. 9  
D-66999 Hinterweidenthal/Germany  
Tel. +49/63 96/92 15-0  
Fax +49/63 96/92 15-25  
stein@stein-maschinenbau.de  
www.stein-maschinenbau.de

Firms in this issue	6	<b>Pelletizing – Case Study</b>	
Imprint	7	High-Performance Cartridge Filter System stabilizes XPS Extrusion	44
<b>Industry News</b>	8	<b>3D Printing</b>	
Calendar	8	Benefits for Electroplating Industry	47
Interplas 2020 Expands	8	<b>Measuring Technology</b>	
3rd International Recycling Forum	11	Digital X-ray Measuring Technology in the Production of Hoses and Tubes	48
Science Award Presentation	11	<b>Measuring Technology</b>	
CHINAPLAS 2019 Show Report	12	iINNOVATE, iNVENT, iINTERACT – Novelties made by iNOEX GmbH on K 2019	51
Flexibility & Innovation	13	<b>Pipe Extrusion</b>	
Realignment of Branding and Corporate Strategy	14	PVC-O Pipes and Fittings for Industrial Applications	54
Expansion of Polymers Portfolio	14	<b>Film Extrusion</b>	
Market Study: Fillers-Europe	15	Highlights in the Film Blowing Technology from Russia	56
Start of the Study on Collaboration for Promotion of Gasification		<b>Circular Economy – Interview</b>	
Chemical Recycling of Plastic Waste	16	Recyclers are investing strongly	58
Third Production Line for PET Polymer Producer	16	<b>Circular Economy – Interview</b>	
Household Refuse Sorting Plant extended with a PET Washing Unit	17	“Circular economy will give us a competitive edge”	59
Shrink Sleeve Film	18	<b>K 2019 Düsseldorf</b>	
New 500 Series Rubber/Silicone Extrusion Crosshead	18	Circular Economy: Hot Topic at K 2019	60
The Biggest Cross Head for Pipe Coating PO 1000 CR	20	Two premieres at K 2019	62
Autoflex™ Die Reduced Gauge Variation and Downtime	22	New Technological Developments for Sustainable Packaging Solutions	64
Additive Masterbatch Makes Black Plastic Packaging ‘Visible’ to Sorting Systems	22	Faster, Quicker, and Less Expensive: Flat Dies Reworked with Cutting-Edge Technology	65
Leadership Change	24	New Models Extend Applications for COMPEO Compounders	66
Plastic Industry Veteran Mirek Planeta retires	24	Automation and Auxiliary Equipment for the Plastic Industry	67
Automation Company Inspires and Motivates Students to Pursue Science/Technology Careers	25	New Equipment and Software Applications	70
Phosphite Antioxidant now has Broader Approval for Food-Contact Applications	25	New Standards in the Field of Optical Profile Measuring Systems	71
New 800 Series Hybrid Extrusion Tooling	26	Mixing System and Container Mixer	72
Focused Sale of Industrial Resin Business announced	26	Single-Screw Extruder for Small Pipe and Profiles with New Control Unit	73
Personal Touch secures Order	27	Pioneering Circular Economy	74
Strech Film Production expanded	27	Compact Extruder	75
<b>Film Extrusion</b>		New Generation of Extruder Degassing Systems	76
OptiFlex Line – How Adjusting Thickness and Flatness of Film Becomes Fast&Easy	28	Slitting and Winding Solutions for Film Manufacturers and Converters	77
<b>Extrusion Technology</b>		Cast Line for Stretch Film Production	78
Innovations for Compounding and Recycling	30	Fine Mesh Straining of Rubber Compounds for the Highest Requirements	79
<b>Periphery</b>		“Creating Change Together”	80
Coated Melt Pumps ensure Product Quality	32	Treatment Technology for the Plastics Industry	81
<b>Pipe Extrusion</b>		New BRUGGOLEN® Additives overcome Performance Boundaries	82
Higher Performance and Productivity of the Pipe Extrusion Plasts Thanks to Industry 4.0 Development	34	Color Masterbatch	84
<b>Thermoforming – From the Research</b>		New Form/Cut/Stack Thermoformer	85
Optimisation of the Plug Geometry in Plug Assisted Thermoforming to increase Material Efficiency	38	Multilayer Blow Molding Machines and Technical Products	86



**30** The Upper Austrian “MAS Maschinen- und Anlagenbau Schulz GmbH”, inventor and established supplier of the conical co-rotating twin-screw extruder system, will introduce two new innovations for the compounding and the recycling technology beyond the twin-screw extrusion technology at the K 2019

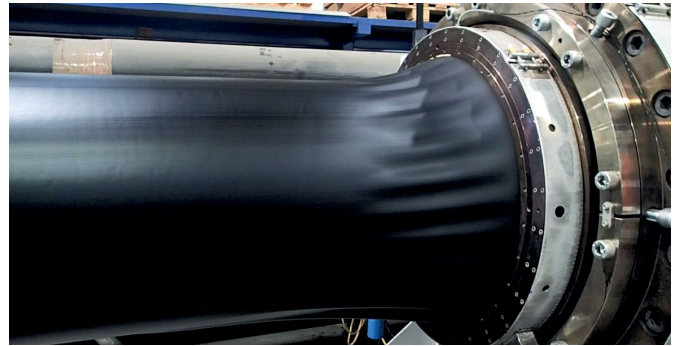

**34** Pipe manufacturers are more and more oriented towards cost efficiency and energy saving, but always aiming at the best performance and output rate achievable for their pipe extrusion lines. Tecnomatic will exhibit innovative solutions for pipe extrusion at this years K-show

BUSS's new COMPEO 88 and COMPEO 110 kneaders for plastics and elastomers are to be introduced at K2019, adding two higher throughput models to the COMPEO range of compounding systems

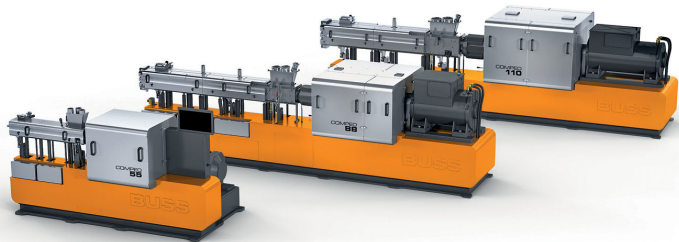

Despite the many advantages of plastics, this important raw material has come into disrepute for some time now – because of the plastic waste that pollutes entire regions and floats in huge carpets on the world’s oceans. But this problem can be solved. As the concept of “circular economy” plays a central role in this, it has become a hot topic at K 2019

**60**

Vetaphone, the Danish manufacturer and pioneer of Corona surface treatment will be displaying a diverse range of surface treatment technology for the plastics industry at K 2019

**81**



ILLIG Maschinenbau will be presenting multiple technological novelties at the K 2019. At this year’s stand the focus will be on sustainable packaging solutions according to the theme of circular thinking with aspects such as Designed for Recy-ling and Eco Design

**64**

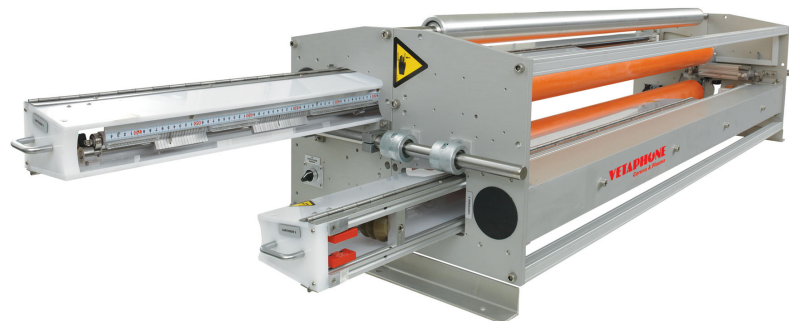

## Extruders & Compounders from stock



## Made in Germany

Visit our homepage for more details ...

Lab. & co-extruders and 25 mm co-rotating compounders, etc.  
cooling/tempering tanks, puller, winder, etc.  
used extruders and equipment

[www.pmh-extruder.com](http://www.pmh-extruder.com) [pmh.gmbh@t-online.de](mailto:pmh.gmbh@t-online.de)



**Plastic-Maschinen-Handelsges. mbH**

Broichhausener Str. 4 · D-53773 Hennef  
Tel. +49-2244-83041 · +49-(0)173 150 4512



Extruder 30 mm - 28 l/d  
immediately available

## Index of Advertisers, companies and fairs referred in this issue

<b>Adsale</b> .....	12, 83	<b>ILLIG</b> .....	64
<b>ALEKO</b> .....	56, 57	<b>iNOEX</b> .....	21, 51
<b>AMUT</b> .....	78	<i>Interplas 2020</i> .....	8
<b>ASCONA</b> .....	71, 73	<b>Jwell</b> .....	7
<b>AZO</b> .....	15	<i>K 2019</i> .....	60
<b>Bandera</b> .....	13	<b>Kampf</b> .....	31
<b>BARS-2</b> .....	33	<b>Kautex</b> .....	80
<b>battenfeld-cincinnati</b> .....	53, 73	<b>KraussMaffei</b> .....	74
<b>Bekum</b> .....	65	<b>KÜNDIG</b> .....	37
<b>Betz-Chrom</b> .....	47	<b>Maag</b> .....	14, 24, 44, 71
<b>Brabender Technologie</b> .....	70	<b>MAS</b> .....	30, 61
<b>Breyer</b> .....	Outside Cover, 28	<b>Messe Düsseldorf</b> .....	60
<b>Brüggemann, L.</b> .....	82	<b>Molecor</b> .....	54, 55
<b>Busch Vakuumpumpen</b> .....	76	<b>Moretto</b> .....	67
<b>BUSS</b> .....	66	<b>motan-colortronic</b> .....	45
<b>CCA</b> .....	69	<b>NGR</b> .....	39
<b>Ceresana</b> .....	15	<b>Nordson Polymer Processing</b> .....	16, 18, 22
<b>Chinaplas</b> .....	12, 83	<b>Piovan</b> .....	17
<b>Clariant</b> .....	22	<b>PLAS MEC</b> .....	13, 72
<b>CONEXTRU</b> .....	20	<b>PLASTICO TRADING</b> .....	75
<b>Eprotec</b> .....	32	<b>pmh</b> .....	6
<b>EREMA</b> .....	49, 58	<b>ProTec Polymer Processing</b> .....	62
<b>Erge</b> .....	67	<b>Reifenhäuser</b> .....	65
<b>Extricom</b> .....	41	<b>RIKUTEC</b> .....	86
<b>FDM</b> .....	29	<b>RIGK</b> .....	11
<b>Feddersen, K.D.</b> .....	14	<b>SI Group</b> .....	25, 26
<b>Formnext</b> .....	Inside Back Cover	<b>Sikora</b> .....	35, 48
<b>Gabriel-Chemie</b> .....	84	<b>Stein Maschinenbau</b> .....	Inside Front Cover+3
<b>Geng-Mayer</b> .....	77	<b>Tecnomatic</b> .....	23, 34
<b>Gneuss</b> .....	19	<b>TROESTER</b> .....	75
<b>GN Thermoforming</b> .....	85	<b>UBE</b> .....	16
<b>GOEBEL IMS</b> .....	77	<b>UTH</b> .....	79
<b>Graewe</b> .....	79	<b>Vetaphone</b> .....	27, 81
<b>Guill</b> .....	18, 26, 63	<b>Weber, Hans</b> .....	9+10
<b>Herrmann Ultraschall</b> .....	59	<b>Zambello</b> .....	Outside Back Cover
<b>Herbold Meckesheim</b> .....	17	<b>ZwickRoell</b> .....	11
<b>IKV-Aachen</b> .....	38		



The Extrusion International Digital Magazine is published bimonthly by VM Verlag GmbH. P.O.Box 501812, D- 50879 Cologne, Germany

**EDITORS**

Bettina Jopp-Witt (Editor-in-chief)  
Tel. +49 221 546 1539  
redaktion@vm-verlag.com

Dmitry Kosuch  
Tel. +7 996 730 0113  
d.kosuch@vm-verlag.com

**ADVERTISING SALES**

Martina Lerner  
Tel.:+49 6226 971515  
lerner-media@t-online.de

Bella Eidlin  
Tel.: +49 152 29907895  
b.eidlin@vm-verlag.com

**ADMINISTRATION**

Alla Kravets  
Tel. +49 2233 949 8793  
a.kravets@vm-verlag.com

**PRINTING**

EVROGRAFIS D.O.O.  
Puhova ulica 18, 2000 Maribor, Slovenija  
T.: +386 2 608 92 25, Fax.: +386 2 601 85 21  
www.evrografis.si, info@evrografis.si

**SALES REPRESENTATIVES**

Quaini Pubblicita (Milano IT)  
Tel. +39 02 39216180  
info@quaini-pubblicita.it

China & Asia  
octavia@ringier.com.hk, Tel. +852-9648-2561  
maggieliu@ringiertrade.com, Tel. +86-13602785446

Tokyo PR Inc. (Japan)  
Tel. +81 (3) 3273-2731  
extrusion@tokyopr.co.jp

**Reprints, Translation etc**

No part of this publication may be reproduced, stored in a retrieval system, or transmitted, in any form or by any means, electronic, mechanical, photographic, recording or otherwise, without prior permission of the publisher.

[www.extrusion-info.com](http://www.extrusion-info.com)



**PP Honeycomb Board Extrusion Line**

**Double Wall Corrugated Pipe Extrusion Line**

**SPC Calcium-plastic Environmental Floor Extrusion Line**

**SHANGHAI JWELL MACHINERY CO.,LTD.**  
Add:No.111 Chun Yi Road,Jia Ding District., Shanghai  
Tel: 86-21-69591818 69591111  
[www.jwell.cn](http://www.jwell.cn)  
[sales@jwell.cn](mailto:sales@jwell.cn)



#### K' 2019

16. – 23. 10. 2019  
Dusseldorf / Germany  
Messe Düsseldorf GmbH  
[www.k-online.de](http://www.k-online.de)

#### Central Asia Plast World

20. – 22. 10. 2019  
Almaty / Kazakhstan  
[www.plastworld.kz](http://www.plastworld.kz)

#### US Biobased Coatings Summit 2019

13. – 14. 11. 2019  
Dallas, TX / USA  
[www.wplgroup.com/aci/event/us-biobased-coatings-summit/](http://www.wplgroup.com/aci/event/us-biobased-coatings-summit/)

#### Plastics Recyclers

21. – 22. 11. 2019  
Brussels / Belgium  
[www.plasticsrecyclersam.org](http://www.plasticsrecyclersam.org)

#### PlastEurasia

04. – 07. 12. 2019  
Istanbul / Turkey  
[www.plasteurasia.com](http://www.plasteurasia.com)

#### interplastica 2020

28. – 31. 01. 2020  
Moscow / Russia  
[www.interplastica.de](http://www.interplastica.de)

#### COMPLAST South Africa 2020

03. – 05. 03. 2020  
Johannesburg, South Africa  
[www.complastexpo.in](http://www.complastexpo.in)

#### wire 2020 and Tube 2020

30. 03. – 07. 04. 2020  
Düsseldorf / Germany  
[www.wire.de](http://www.wire.de), [www.Tube.de](http://www.Tube.de)

#### Plastasia 2020

19. – 22. 06. 2020  
Bangalore, India  
[www.plastasia.in](http://www.plastasia.in)

## Interplas 2020 Expands

### *“The UK Plastics Industry Backs the Leading Show”*

29th September – 1st October, 2020 Birmingham, UK

■ For the first time in 15 years, the show will fill two halls at Birmingham’s NEC, where an expected 500 companies will demonstrate the machinery, materials and services available to meet the current and future challenges of plastics processors. Over 72% of the combined floorspace across the two halls is already sold.

Interplas is renowned for its machinery and product demonstrations. Visitors to the 2020 edition will be able to see an expanded portfolio from several exhibitors who have added to their ranges in order to meet the evolving needs of the market.

Innovation will continue to play a key part at Interplas 2020, with the return of the ‘Interplas Innovation Award’ giving exhibitors the opportunity to demonstrate cutting-edge technologies that will enable visitors to get ahead.

New features at the show in 2020 will be a greater focus on Sustainability, in response to the current changes facing the industry in the transition to a circular economy. Through a dedicated guide and stand markers, visitors will be able to easily identify those companies offering insight and experience that can help them achieve their sustainability goals, whether it be with machinery, materials or services.

This will be complemented by the ‘Sustainability Stage’, a dedicated conference theatre that will host three full days of free-to-attend presentations, panel discussions and Q&A forums where experts will give tailored insight to the ways in which the UK plastics industry can lead the way in sustainable manufacturing, recycling and resource use.

Additionally, there will be a brand-new focus on extrusion machinery, materials and associated technologies, after a surge in demand from exhibitors in this area. To enhance a visit with further insight and information, a dedicated ‘Extrusion Stage’ will provide end users in the UK with a three-day programme giving a unique opportunity to discover the latest machinery, materials and methods for efficient and economic processing, as well as end-of-life considerations.

Other highlights for visitors include the return of the Women in Plastics industry group, with a conference and networking programme, as well as the Knowledge Pavilion, where visitors can source information and advice across areas from funding and exporting to R&D and consultancy.

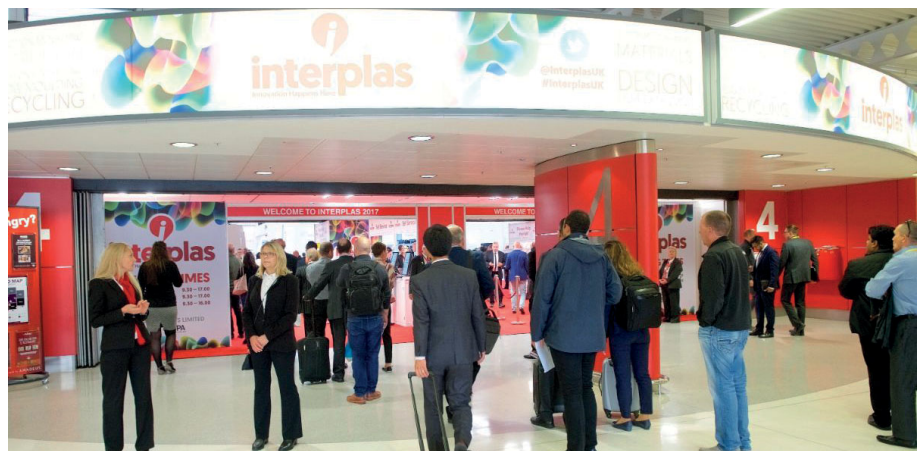



What you need? **More Power**. WEBER have developed the High Performance series DS 32 D especially for the production of polyolefin pipes. It offers four powerful extruder models

High Performance series DS 32 D particularly energy-efficient!

also makes the technology

unique

Make a great start with even more power from Maschinenfabrik WEBER.

increase of up to 40%. The which guarantee an output

[hansweber.de](http://hansweber.de)





DS 32 D

# DS 32 D: the PVC pipe extruder with IF Screw® technology

Do you want to further improve what is already good?

You can make your pipe production even more **economically efficient** with proven, **efficient** WEBER drive technology and a new, revolutionary screw geometry. The latest generation of extrusion screws feature good plasticisation, homogenisation and deflocculation – even for plastics with difficult processing characteristics.

And all this with the **reliability** that you know from WEBER extruders.

## Advantages

- // **Durable**, compact and robust WEBER gear technology, made in Kronach
- // **Improved** product qualities, also for recycled PVC and high content PVC
- // **Maximum** output range
- // Processing of cold mixtures



Scan code and  
download data sheets  
[extrudertechnologie.de/  
en/pipe](http://extrudertechnologie.de/en/pipe)



Hall 16,  
Booth F06

## 3rd International Recycling Forum

■ RIGK GmbH and the European Association of Plastics Recycling & Recovery Organisations (EPRO) are issuing an invitation to the 3rd International Recycling Forum which will run from 26th to 28th November 2019 in Wiesbaden, Germany. The event will focus on trends and strategies relating to the application of circular economy principles to plastics. Some thirty papers and presentations will cover topics ranging from design for recycling via innovative recycling technologies and extended producer responsibility (EPR) to making efficient use of recycled materials. The emphasis of the second day of the forum will be on the collection and recycling of agricultural plastics. An accompanying exhibition will provide further information about the sector. The language of the conference is English. The registration form and further information, list of exhibitors and conference program can be found at:



■ RIGK GmbH  
[www.international-recycling-forum.de/en](http://www.international-recycling-forum.de/en)

## Science Award Presentation

■ On June 14, 2019, the winners of the 2018 ZwickRoell Science Award were recognized at the 10th annual ZwickRoell Academia Day held at the Tongji University (CHN). The event, which takes place at a different international university or institution every year, provides an important platform for the intensive exchange between science and industry on the subject of intelligent materials testing.

*From the left: Yan Li, Daniel Barba, Dr. Jan Stefan Roell, Simon Vitzthum, Tom Petit, Y.J. Zhao, Benhard Pichler, Robert Strehle (Image: ZwickRoell)*



The Tongji University in Shanghai is particularly recognized in the disciplines of engineering, economics, and architecture. It is under direct administration of the Chinese Ministry of Education and belongs to the 33 universities listed under Project 985, which promotes the development of world-class institutions.

This year, first place went to Daniel Barba from the University of Oxford for his work on the ultrafast valuation of high-temperature creep properties of miniaturized metal specimen. Simon Vitzthum from the Technical University of Munich took second place for his publication on the temperature-based determination of the onset of yielding using a new clip-on extensometer for tensile tests. Third place was presented to two participants, Y.J. Zhao from the Zhejiang University for her method of in-situ voltage impedance monitoring in magnetic fields and Tom Petit from the French Alternative Energies and Atomic Energy Commission (CEA) for his publication on the impact of machine stiffness on pop-in crack propagation instabilities. The 8,000 EUR prize is awarded for the particularly innovative use of a materials testing machine in research and science. Applicants for the 2019 ZwickRoell Science Award can submit their work by December 2019. The award presentation will take place again on ZwickRoell Academia Day, on June 5th, 2020 at the Vienna University of Technology.

■ ZwickRoell GmbH & Co. KG  
[www.zwickroell.com](http://www.zwickroell.com)

## CHINAPLAS 2019 Show Report

■ A successful CHINAPLAS 2019 concluded its four-day show in Guangzhou this May. The hot and rainy weather prior to the 33rd edition of show did not hamper the enthusiasm of visitors, who were inspired by smart manufacturing, innovative materials, and green & circular solutions. A total of 163,314 professional buyers from all over the world visited CHINAPLAS during the four days. CHINAPLAS 2019 recorded the highest visitor count in Guangzhou editions' history.

CHINAPLAS 2019 attracted 163,314 professional buyers. The number of overseas visitors totaled 37,170, accounting for 22.8% of the total. They came from 150 countries and regions, including Brazil, India, Indonesia, Iran, Japan, South Korea, Malaysia, Pakistan, the Philippines, Russia, Singapore, Thailand, Turkey, Vietnam, and the United States. Compared with the Guangzhou edition of show two years ago, the number of visitors increased 8,056. Grouped by job titles, 26.4% of visitors were Manager/Assistant Manager/Supervisor. 23.0% of visitors were Managing Director/General Manager/Plant Manager. Percentage of Technician took 13.3% while percentage of research/academic personnel took another 12.9%. According to a survey conducted onsite by the show organizer, 90% of visitors commented that the variety of the new products/technologies was good to excellent. 94% of visitors concluded the quality of exhibitors was good to excellent. And encouragingly, 93% of visitors expressed that the overall performance of the exhibition was good to excellent.

3,622 exhibitors from 46 countries and regions participated in CHINAPLAS 2019. 95% of them concluded the exhibition result from satisfactory to very fruitful, which has brought great benefits and opportunities for them. 3,622 global exhibitors showcased their innovative prod-

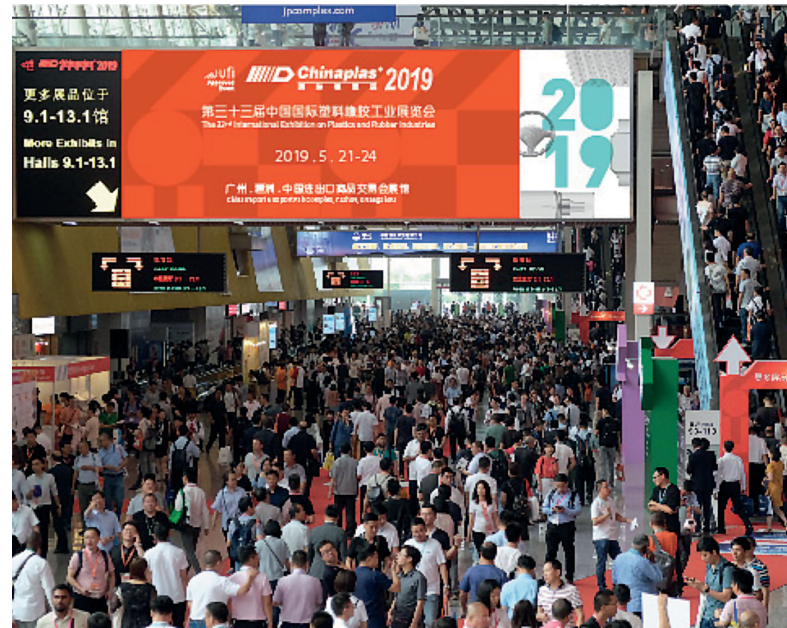

ucts and technologies, including 180+ worldwide or Asia debut of new and hot technologies, 130+ energy-saving and emission-reducing solutions, 160+ recycling and recovery technologies, and 1,400+ automation solutions. A full CHINAPLAS 2019 show report is available now.

CHINAPLAS is currently Asia's No. 1 and the World's leading plastics and rubber trade fair and certified by UFI (The Global Association of the Exhibition Industry) since 2006. With the support of worldwide exhibitors, CHINAPLAS is not only an effective business exchange platform but also a crucial hub for innovative and focal technologies for the industry. Through a full spectrum of product demonstration and collaborative activities, the show is casting the spotlight on "Smart Manufacturing, Innovative Materials, Green and Circular Solutions". Visitors are happy to explore the turnkey solutions, covering chemical raw materials, machinery, and equipment needed by Asian manufacturing. They can also take a step forward to grasp the countless opportunities in rising markets of China and Asia.

The next edition of CHINAPLAS will rotate to Shanghai, on April 21-24, 2020, with the exhibition area of 340,000 sqm. It's expected that the fair will create brilliant achievements and break new records in next year.

By Job Title 职级分类

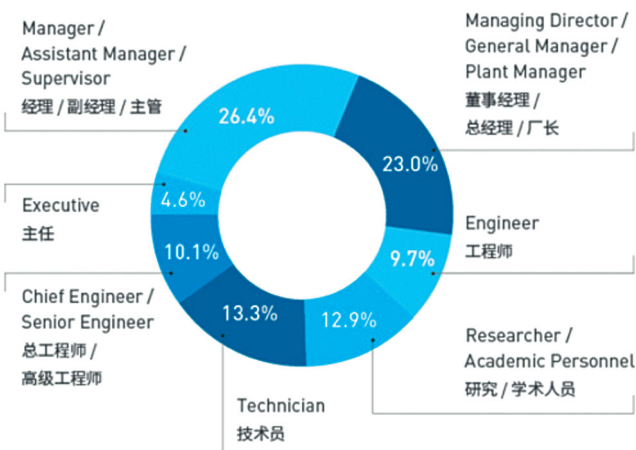

# Flexibility & Innovation

Bandera hits the market with two SmartFlex® lines in Poland and Slovenia

■ Greater flexibility is the key aspect that makes the SmartFlex® lines the most appreciated and required by customers among the other Bandera Blown Film technologies.

This range of machines allows the processing of several materials and films, with an excellent sustained output.

The SmartFlex® lines also offer many more advantages, such as:

- Competitive investment level;
- Low energy consumption;
- Easy management.

Recently, two SmartFlex® lines have been delivered to two producers from Eastern Europe: one in Poland and one in Slovenia.

End products that both the customers will produce from their new lines are: shrink film for bottles and cans, shrink-hood film, lamination and converting film. Main technical features of the two plants:

**Materials:** • LDPE, EVA, LLDPE, mLLDPE and blends with MDPE, HDPE, coPP. • The possibility to process biodegradable and compostable resins.



**Output:** 400 ÷ 500 kg/h    **Thickness range:** 20 ÷ 200 µm    **Layflat:** 2200 mm net

► **Costruzioni Meccaniche Luigi Bandera SpA**  
[luigibandera.com](http://luigibandera.com)



For over **50 years** a landmark in the international market for the **manufacturing of complete mixing plants**

**PVC DRY BLEND - POWDER COATINGS**  
**MASTERBATCH AND PIGMENTS - THERMOPLASTIC RUBBER**  
**WOOD PLASTIC COMPOSITES**



Hall 09  
 Stand 9A60

**PLAS MEC S.R.L.**  
 Via Europa, 79 - 21015 Lonate Pozzolo (VA) **ITALY**  
 Tel: +39 0331 301648 - E-mail: [comm@plasmec.it](mailto:comm@plasmec.it)  
[www.plasmec.it](http://www.plasmec.it)



## Realignment of Branding and Corporate Strategy

■ The Swiss company Maag Pump Systems AG has grown through acquisitions in recent years and has significantly expanded its product portfolio. A realignment of its branding and corporate strategy will further strengthen the company's position as a broadly diversified global solutions provider with integrated and customizable system solutions. Maag's process technologies for the polymer, chemical, petrochemical, pharmaceutical and food industries help customers achieve the next level of productivity. Maag Group is bundling the activities of the companies it has acquired in recent years into four centers of excellence: Pump & Filtration Systems, Pelletizing Systems, Pulverizing Systems, and Recycling Systems. All of the companies will in the future be managed as product brands – AUTOMATIK, ETTLINGER, GALA, MAAG, REDUCTION, and SCHEER – under the MAAG Group umbrella brand.

"The focused market orientation, with our products and services spread across four centers of excellence, will play a major role in the MAAG Group's further international growth in the coming years. Our aim with the new umbrella brand strategy is to strengthen our identity on the market. The established product brands enjoy great trust and confidence among their customers, and will remain specialists in their respective market segments, yet work close together when integrated systems solutions are required" says Group president Ueli Thuerig. "We expect the integration of all our product brands under the umbrella of the MAAG Group to provide us with a further boost to innovation in cutting-edge technology, even higher standards in our worldwide after-sales service, and even better solutions to meet demanding customer requirements in the production, processing and recycling of polymers. As the MAAG Group, we aim to be available for our customers at all times, all over the world, deploying the extensive know-how of our more than 1,000 employees at our 20 locations."

The rebranding clearly expresses that we will act as one team to the benefit of our customers. The consolidated branding will

*Ueli Thuerig, President Maag Group*



underpin the further integration of the Pump, Filtration, Underwater Pelletizing, Strand Pelletizing, Drying, Pulverizing and Recycling divisions, which are already working together successfully on many development and service projects to deliver solutions for their customers. The new brand and business strategy will be presented for the first time at K 2019. The MAAG Group is the visually identifiable umbrella brand; with the product brands each distinctively echoing it.

The claim "NEXT-LEVEL SOLUTIONS" embodies the MAAG Group's core performance promise, extending across all areas of the business. It is about generating maximum added value based on an understanding of customers' aims and processes. It relates to the development of high-quality, high-performance solutions by international interdisciplinary development teams within the MAAG Group. It focuses on value for money in delivering sustainable and durable products, plants and systems. It encompasses a global service network ensuring that customers can run their machines successfully. It also reflects the development of advanced solutions for the circular economy for polymers, and future sustainability of the production and processing of modern plastics as an innovative material for a wide range of applications.

The MAAG Group booth at K 2019 will be presenting innovations from the Pump & Filtration Systems, Pelletizing Systems, Pulverizing Systems and Recycling Systems centers of excellence. A complete downstream system for recycling will demonstrate how solutions for a circular economy can be implemented by the MAAG Group as an integrated solution provider from a single source.

**K 2019: Hall 9, Booth A04**

■ **Maag Group**  
[www.maag.com](http://www.maag.com)

## Expansion of Polymers Portfolio

■ Hamburg/Germany-based distributor K.D. Feddersen expands its product portfolio of the Spanish manufacturer ELIX Polymers S.L. in Germany, Austria, France, Great Britain, Ireland, Sweden, Denmark, Norway and Finland.

CADON CG 28 is an acrylonitrile-butadiene-styrene (ABS) with a high rubber content and medium flow properties. Due to its special product composition, it has a high toughness and a very high impact resistance at low temperatures. The ABS compound is only available in its natural color and is suitable for self-coloring due to its light inherent color. The product is a good choice for standard ABS applications and offers good value for money due to its properties.



The ABS portfolio is constantly being expanded and further interesting products from ELIX Polymers will be presented at K 2019.

■ **K.D. Feddersen GmbH & Co. KG**  
[www.kdfeddersen.com](http://www.kdfeddersen.com)

## Market Study: Fillers–Europe

■ Fillers not only make many products cheaper, they often also improve their properties, such as stability, weather-resistance, and electrical conductivity, of numerous products. Ceresana has already analyzed the global market for these important materials several times. Now, the market research company publishes a study on the European fillers market for the first time: European demand for ground calcium carbonate (GCC), precipitated calcium carbonate (PCC), kaolin, talc, carbon black, and other fillers will presumably increase to about 18 million tonnes in 2026. The Study in Brief: Chapter 1 provides a description and analysis of the European market for fillers – including forecasts up to 2026. For 22 European countries, demand in tonnes and revenues in euros are given. Furthermore, the European and country-specific demand per product type and application area is analyzed. The following filler types are examined in detail: Ground Calcium Carbonate (GCC), Precipitated Calcium Carbonate (PCC), Carbon Black, Kaolin, Talc, Other Fillers. The analyzed application areas are: Paper, Plastics, Paints and Coatings, Elastomers, Adhesives and Sealants. Chapter 2 analyzes the 22 most important countries and their filler revenues and demand. Demand is split by individual applications and product types; the demand of the particular product type split by applications is analyzed. Additionally, all important manufacturers of fillers are listed according to countries. Chapter 3 provides useful profiles of the largest manufacturers of fillers, clearly arranged according to contact details, turnover, profit, product range, production sites, profile summary, and product types.

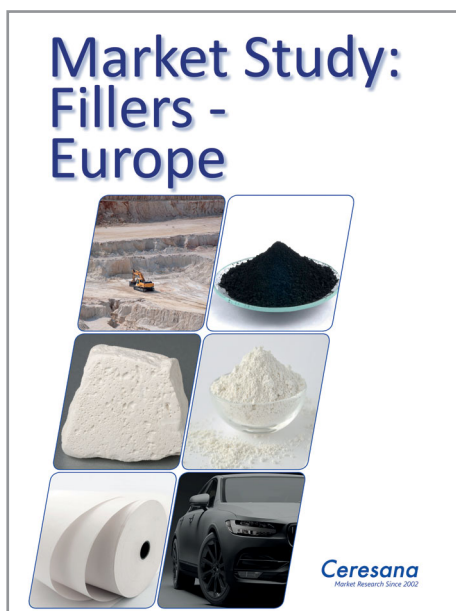

■ Ceresana  
[www.ceresana.com/en/market-studies/chemicals/fillers-europe/](http://www.ceresana.com/en/market-studies/chemicals/fillers-europe/)

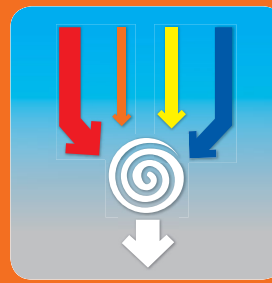

Efficient  
dryblend  
mixer  
feeding

## AZO<sup>®</sup> Vacuum weighing systems

- low-dust
- highly accurate
- economical



**AZO<sup>®</sup>**  
**www.azo.com**

## Start of the Study on Collaboration for Promotion of Gasification Chemical Recycling of Plastic Waste

■ JGC Corporation, Ebara Environmental Plant Co., Ltd., Ube Industries, Ltd., and Showa Denko K.K. announced that they started a study of collaboration for an Engineering, Procurement and Construction (hereinafter, "EPC") business for plastic waste gasification facilities utilizing the Ebara Ube Process (hereinafter, "EUP") following conclusion of a non-disclosure agreement on July 31, 2019.

**1. Aim of Promoting Gasification Chemical Recycling of Plastic Waste:** Promotion of plastic waste recycling has become a global issue, as seen in the ocean microplastic problem. While Japan's plastic recycling ratio is 86%, only 13.5% of the plastics waste are recycled as resources and the rest is exported to other countries or thermally recycled (fiscal 2017)\*. Furthermore, establishment of resource recycling systems is urgently needed in Japan and other countries amid tightening regulations for solid waste import in China and Southeast Asian countries. Gasification chemical recycling of plastic waste is capable of decomposing a mixture of various kinds of plastics and impurities, which presents difficulties for other recycling methods, into the molecular level and regenerating various chemical materials. It should contribute to substantial improvement of the recycling ratio.

\* Source: "Plastic Products, Plastic Waste and Resource Recovery [2017]" (Plastic Waste Management Institute)

**2. Ebara Ube Process (EUP):** The EUP, which was developed by EBARA CORPORATION (transferred this business to Ebara Environmental Plant in 2009) and Ube Industries in 2000, is a process that gasifies plastic waste using partial oxidation with oxygen and steam, and produces synthesis gases that can be utilized in synthesis of ammonia, olefins, and other chemicals.

A gasification facility steadily operating at Showa Denko's Kawasaki Plant (annual plastic waste processing capability: ap-



proximately 70,000 tons) since 2003 applies EUP. This is the only technology for gasification chemical recycling in the world with a long-term track record of commercial operation.

**3. Plans:** The four companies (JGC, Ebara Environmental Plant, Ube Industries, and Showa Denko) aim to conclude an EUP licensing contract within the year, and then actively implement sales efforts for gasification facilities for plastic waste adopting EUP in Japan and other countries and conduct EPC activities. They also intend to promote the spread of gasification chemical recycling and use of recycling in Japan and other countries via proposals for chemical production facilities utilizing ammonia, olefins, and other chemicals made from facilities which adopt EUP.

K 2019: Hall 6, Booth E08

► UBE Europe GmbH  
www.ube.com

## Third Production Line for PET Polymer Producer

■ Twelve years ago, NEO Group purchased BKG® underwater pelletizers and related components for three PET polymerization lines but installed only two, storing the unused BKG equipment in their original shipping boxes. Today the company has a new, third PET line, making it the second-largest PET producer in Europe, and those 12-year-old BKG pelletizers are hard at work as if they were delivered yesterday.

NEO Group had purchased the PET production lines from Zimmer AG, including twelve BKG underwater pelletizers – four for each

polymerization line – plus polymer diverter valves, gear pumps, water systems, pellet dryers, and controls.

"The smooth startup of the pelletizing systems reflects the high quality inherent in BKG products," said Godfrey Sandham, vice president, Nordson Polymer Processing Systems, Europe. "It was the excellent reputation of BKG pelletizers and melt delivery components that drove Nordson to acquire these businesses," noted Sandham. "Since then we have invested heavily in processes for continuous improvement of our products and have just completed construction of a global hub for the BKG brand in Münster, Germany."

NEO Group complex at Klaipeda, Lithuania



► Nordson Polymer Processing Systems  
www.nordsonpolymerprocessing.com  
NEO Group  
https://neogroup.eu/



# Household Refuse Sorting Plant extended with a PET Washing Unit

■ The recycling of PET bottles is an extension of the Russian waste disposal company MAG Group's recycling activities and is a consistent step towards a circular economy. The HERBOLD washing plant is being installed in Nizhny-Novgorod at the MAG daughter company Fantastik-Plastik. The MAG Group has been active as a conventional waste disposal company and is running a modern sorting plant for domestic waste, commissioned in 2018. After a consultancy and planning phase of several years, the company decided to also follow new paths with the recycling of PET by processing themselves the sorted fraction of PET bottles. The washing plant with hot wash will go into regular operation in Nizhny-Novgorod in the fourth quarter of 2019. Company director Sergej Khalevskij summarises the aims: "We are pursuing a clear vision: processing of the sorted PET fraction into high-quality PET flakes is a crucial step towards making plastic waste available again as raw material." The output of the new HERBOLD washing plant is 1500 kg/hour.

After successful development of the distribution channels, a further extension of the plant is already planned.

HERBOLD Meckesheim GmbH  
[www.herbold.com](http://www.herbold.com)  
 MAG Group  
[www.mag-rf.ru](http://www.mag-rf.ru)

## From state of the art dosing units to complete turn key automated solutions



### Suitable for Flexible Film applications

- Continuous extrusion control
- Better blend homogeneity
- Maximum dosing accuracy and versatility thanks to double load cells
- Efficiency of production and equipment uptime
- Utmost flexibility and traceability in materials management



Winfactory 4.0



Teleservice

Ready



[www.piovan.com](http://www.piovan.com)



Piovan Group

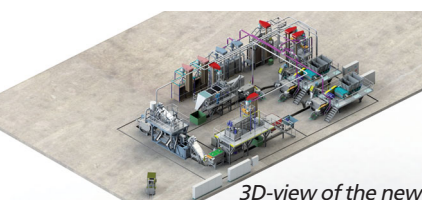

3D-view of the new HERBOLD washing plant for MAG / Fantastik-Plastik, Russian Federation

## Shrink Sleeve Film

■ When a die used by Innovia Shrinkfilms GmbH for making shrink sleeve film yielded product that was often out of tolerance, the company switched to a die from Nordson Corporation that improved tolerances by 30% and reduced startup times. Innovia is a specialty film manufacturer and a division of CCL Industries Inc., the world's largest producer of labels. To supply the fast-growing shrink sleeve segment of the label market, Innovia produces transparent film that is subsequently printed on the inside surface, slipped over a container, and made to conform to the container surface by means of heat shrinking. On the cast film line in which the Nordson die has been installed, Innovia processes a polystyrene blend into monoaxially-oriented film.

The new die is an EDI® Autoflex™ VI-RE H40 unit. Like the previous die, the Autoflex die is an automatic one, using data from a computerized downstream gauging system to adjust the transverse thickness profile by making changes to the flexible upper lip of the die.

"In comparison with our previous die, the EDI Autoflex die from Nordson produces more uniform film with 30% better tolerances," said Giuseppe Ronzoni, Innovia plant manager. "The automatic control of the flexible lip is faster and more accurate and startups are faster than before."

The flexible lip of an Autoflex die is made up of thermally-actuated adjuster blocks that expand or contract to adjust the lip gap in areas of the film that are thicker or thinner than the



Autoflex™ VI-RE die



Packaging with shrink sleeves made from Innovia's film

target dimension. "The upper lip of the Autoflex die is more flexible in that the adjustments to the lip gap take place more rapidly," said Patrick Meinen, polymer dies product manager for Nordson.

Another critical factor for ensuring product quality is the length of the lip land – the lip surface just before the die exit. "The lip land can be made longer or shorter to optimize product thickness, flatness, and surface finish," said Meinen. "Besides having a stiff upper lip, the older die had a lip land that was too short. In our Autoflex die, we optimized the lip land to control the product profile and manage die pressure."

At startups, the rapid gauge profile adjustment provided by the Autoflex system reduces the time before saleable product is produced. Also helping to shorten startups is the design of the flow channel, or manifold, inside the die.

"The greater uniformity of the film produced with the EDI die reduces the potential for gauge bands on the product roll," said Ronzoni. "This leads to less stretching of the final product and better printing results."

■ Nordson Polymer Processing Systems  
[www.nordsonpolymerprocessing.com](http://www.nordsonpolymerprocessing.com)  
 Innovia Shrinkfilms GmbH  
[www.innoviafilms.com/applications/label-films/shrink-sleeve/](http://www.innoviafilms.com/applications/label-films/shrink-sleeve/)

## New 500 Series Rubber/Silicone Extrusion Crosshead

■ Guill Tool introduces the NEW 500 Series crosshead with MAGS gum space adjustment. The 500 Series is designed specifically for the flow characteristics and unique processing challenges of elastomeric compounds. One of the key features engineered by Guill on this new crosshead design is the mechanically assisted gum space (MAGS) adjustment system. This new method of gum space adjustment allows the operator to make an effortless adjustment from a single point using a common socket wrench. No more need to struggle with multiple nuts and bolts in order to adjust gum

space, which leads to faster adjustments. The visual indicator on the core tube allows the operator to see how far the gum space has been moved, making those adjustments much more accurate and repeatable.

The hardware-free and patented cam lock design of the NEW 500 Series from Guill means no time is wasted unbolting and re-securing fasteners for disassembly and re-assembly. Only half of a rotation of the cam nut is required to loosen and automatically extract the deflector from the head body, which is another time saver. Also, with no undercuts on the

deflector, there are no material hang-ups when extracting the deflector, allowing for faster and easier cleaning and changeover.

The NEW 500 Series also features the latest Center-Stage concentricity adjustment system that significantly reduces pressure on the tooling, allowing easier and more precise concentricity adjustments without loosening the face bolts. Easy-Out inserts for the adjusting bolts also allow simple replacement of locked or damaged adjusting bolts, which further saves on repair and downtime.

Another innovative feature of this new rubber/silicone cross-head is a cast aluminum liquid-fed cooling sleeve that allows the user to switch out the cooling jacket in the event of a line obstruction, again reducing downtime compared to traditional integrated cooling systems.

The NEW 500 Series crosshead with MAGS gum space adjustment is a drop-in replacement on most existing NRM lines, however this crosshead design can also be adapted to fit any extruder design or line layout.

The addition of a newly designed flow inlet channel reduces the shear and heat that is generated as the materials are being processed. This leads to lower head pressures allowing the material to move through the head in a much more balanced and even flow.

All crossheads supplied by Guill are furnished with a tool kit for assembly and disassembly as well as a detailed operator's instruction manual. The engineering team at Guill will gladly assist users in the implementation and operation of the NEW 500 series crosshead.

For a video of the NEW Guill 500 Series crosshead with MAGS gum space adjustment, please go to:  
<https://youtu.be/jeNovmMtcBs>

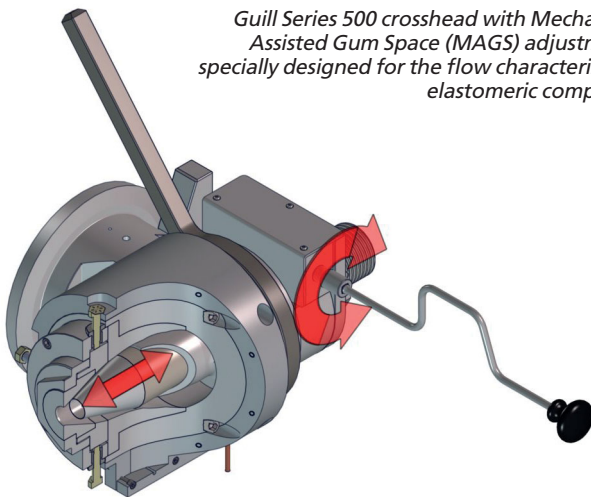

*Guill Series 500 crosshead with Mechanically Assisted Gum Space (MAGS) adjustment... specially designed for the flow characteristics of elastomeric compounds*

# Continuously Constant

## Pressure and process constant Melt filtration

Unique technologies, innovative solutions, comprehensive technical support, high expertise in all kinds of plastics applications. In others words: typical Gneuss.



Hall 9  
Stand A38

## The Biggest Cross Head for Pipe Coating PO 1000 CR

■ The Coating of PE water pressure pipes is one of the most significant pipe market trends nowadays. The process is to cover the PE pipe with an additional PP layer via a coating process. This PP protection layer in the thickness of 0,8 mm to 3 mm allows the installation in the trench without sand. This reduces the cost for installation significantly.

The coating process compared to an extrusion process better, because the protection layer has to peel off before electrofusion- or butt-welding process. PP and PE cannot weld together and the grip or adhesive force is by shrinking of the PP to the PE pipe. Different process parameters can influence the grip. PE pipe temperature is the most influencing one. Such a protection layer can consist of a multilayer structure with either barrier material or any other material combination.

CONEXTRU specialised on extruders & pipeheads has finished the biggest crosshead in the product line of Conextru heads. The application is to coat PE 100 pipe with PP-HM protection layer in range of 1 mm to 3 mm.

### Technical data Pipeheads:

Max. diameter: 1000 mm

Min. diameter: 400 mm

Max. throuput: 250 kg/h PP-HM

Distribution system: Helical spiral, 36 channels, special designed for low output – low volume

Die set system: Add on system – only 3 dies for full diameter range

Stripes: Eight colour stripes – only one unit for full range

Heating: Inside heaters and outside heaters single phase total 130 kW

Vacuum: Vacuum control via PLC from extruder with speed adjustment of blower

Extrusion height: 1250 mm +/- 30 mm built up by side channel compressor

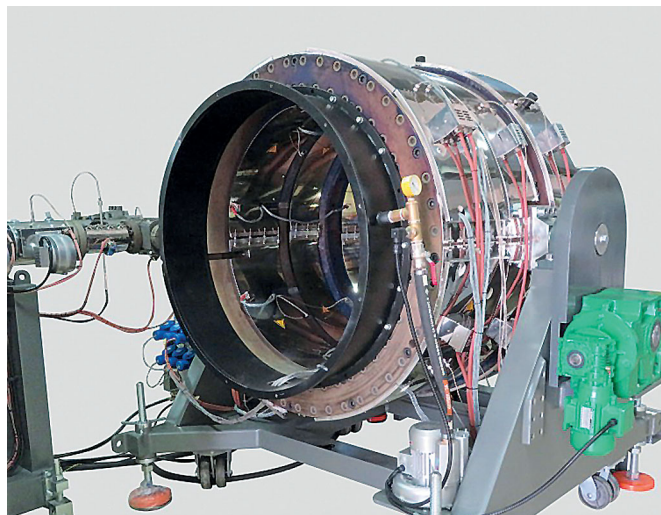
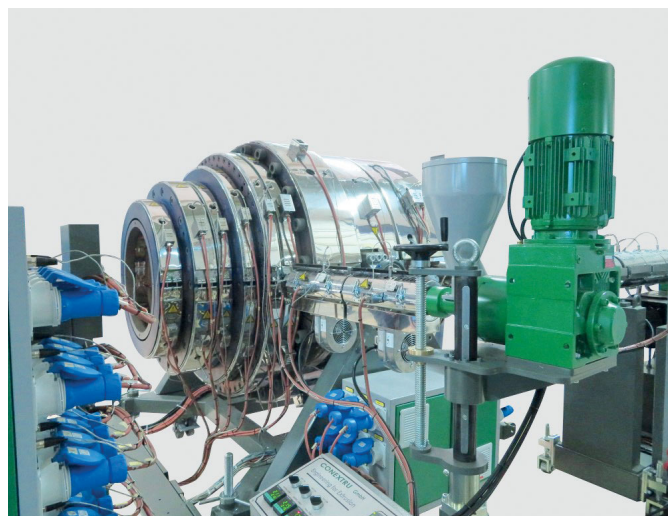

Trolley: Strong design motorised tuning - +/- 90 degree from horizontal position

Flow channel: High glossy polished

Material: 42CRMO4 – surface nitride

### The whole coating equipment:

PO 1000 CR: Range 400 – 1 000 mm, electrical box as interface box for all power cables and thermocouples.

Extruder C 45 30: Max. output 250 kg/h PE / 200 kg/h PP – barrier screw, ABB PLC control, vacuum control for coating process, second control box for head heating, extruder position parallel to extrusion line, 90 degree adapter to head

Extruder C 30 25: Max. output 5 kg/h colour stripe material, height adjustable frame, short connection to colour stripe ring



**iNOEX**  
THE FUTURE OF EXTRUSION



# AUREX MK400 Measuring chamber

THE BENCHMARK FOR INNOVATIVE MEASURING TECHNOLOGY

## Your benefits:

- Highly precise measuring values
- Material savings and constant wall thicknesses
- Uniform and reproducible production
- Comprehensive product data
- Low space required
- Improved centering and optimum pipe guidance



## Autoflex™ Die Reduced Gauge Variation and Downtime

■ Asia Poly Films Industries, a versatile producer of biaxially oriented polypropylene (BOPP) films for packaging, has substantially reduced downtime and increased throughput on a lamination-grade film line by switching to a brand-new EDI® Autoflex™ die from Nordson Corporation.

Since it began producing BOPP film in 2017, Asia Poly Films frequently encountered gauge bands and film sagging with the previous die, making it impossible to achieve the degree of flatness required by customers. It was necessary to clean the die every two or three months – a process that meant 48 to 60 hours of production downtime for each cleaning. The die also exhibited gauge variation that could be held within acceptable limits only if the line speed were limited to no more than 2,800 kg/hr.

Since installing the EDI die in February 2019, Asia Poly Films has been running the film line continuously at 3,500 kg/hr with gauge variation maintained “well within acceptable levels,” according to Dipesh Patel, director. “In addition, while our old die needed about two hours after line startup to stabilize and start producing film with an acceptable level of gauge variation, the new EDI die stabilizes within only 15 or 20 minutes.” Using the new EDI die with the same extruder, controls, and polymer recipe as in the past, Asia Poly Films has produced film with lower haze and better gloss, Patel said.

The EDI die is an Autoflex VI-R triple-manifold unit. Like the die previously used by Asia Poly Films, the Autoflex die is an automatic one, using data from a computerized downstream gauging system to adjust the transverse thickness profile by making changes to the flexible upper lip of the die.

“The Autoflex system responds more rapidly to gauge variations than other automatic dies,” said Mrunal Sanghvi, gen-



EDI® Autoflex™ Die at Asia Poly Films

eral sales manager in India for Nordson’s Polymer Processing Systems business. “In addition, Nordson custom-designed the flow channel, or manifold, inside the die to optimize the flow of the specific polymers used by Asia Poly Films. These are two reasons why the EDI die has enabled Asia Poly Films to achieve saleable product in a shorter time after startup, hold to tighter tolerances during the production run, and increase throughput while maintaining product uniformity and quality.”

Asia Poly Films Industries produces BOPP flexible packaging films for tape and textile, lamination, heat sealable, and release-film applications.

■ Nordson Polymer Processing Systems  
[www.nordsonpolymerprocessing.com](http://www.nordsonpolymerprocessing.com)  
 Asia Poly Films Industries  
[www.asiapolyfilms.com](http://www.asiapolyfilms.com)

## Additive Masterbatch Makes Black Plastic Packaging ‘Visible’ to Sorting Systems

■ New Clariant CESA®-IR additive masterbatches are available to make dark-colored plastics visible to the near-infrared (NIR) sensors used in automated polymer sorting systems. While many companies use black packaging to brand their prestige products, the problems it poses in recycling systems has led to calls for black to be phased out of the palette. The new masterbatches help to resolve that issue and allows increased recycling rates in Europe and elsewhere.

The new product range is part of a „Design for Recycling“ program at Clariant. Recognizing that recycling is the foundation of a Circular Economy, Clariant Masterbatches and its Packaging Market group, is mobilizing substantive resources

across the packaging value chain to ensure that an ever-higher percentage of plastic packaging is recycled.

In most automatic sortation systems, infrared light is beamed onto packaging materials and, because different polymers reflect that light differently, NIR sensors can discriminate between high-density polyethylene, low-density polyethylene, polypropylene, polyester and various other commonly used polymers in today’s packaging. Unfortunately, the carbon black pigments typically used to make black plastics absorb all or most of the NIR light shone at them. As a result, the sorting sensors cannot even “see” the black packaging, much less sort one polymer from another.

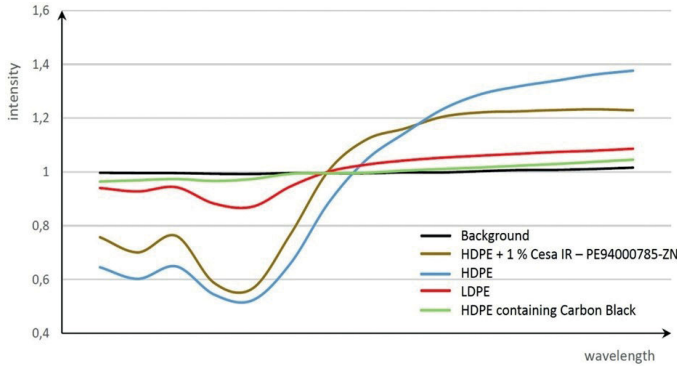

Tests on high-density polyethylene (HDPE) also showed positive results (see graph). HDPE with CESA-IR shows a curve similar to the uncolored HDPE curve and distinct from the LDPE curve and allowing for easy separation. PET and C-PET sheet and film were also tested by Tomra, with similarly positive results (Graph: Clariant)

“As a result of this phenomenon,” explains Alessandro Dulli, Clariant Masterbatches Global Head of Packaging, “much of the dark-colored materials entering the recycling stream has not been recovered. For that reason, many brand owners have been pressured to move away from black for environ-

mental reasons. In close collaboration with these brand companies and as a leader in sortation technology, Clariant has developed a way to achieve a persuasive black color in plastics without compromising the essential detectability during recycling process.”

Specific CESA-IR formulations have been developed to enable IR-detectability of black HDPE and LDPE in injection and extrusion blow-molded products; black polypropylene (PP) in films and injection-molded products; and black PET and C-PET in sheets and film.

In testing conducted by Tomra Systems ASA, a Norwegian company that is a leader in the field of instrumentation for recycling solutions, polypropylene (PP) containing carbon black was essentially indistinguishable under NIR radiation from background surfaces such as a conveyor belt.

However, the same material made using another coloring system including CESA-IR additive masterbatches was readily detectable, with reflectivity levels approaching those of uncolored PP.

K 2019: Halle 8a, Stand J11

Clariant  
www.clariant.com/K2019

# INDUSTRY 4.0 Enabled



- REAL-TIME SYSTEM STATUS
- ETHERNET CONNECTIVITY
- REMOTE MONITORING
- SMART FACTORY COMPATIBILITY
- SENSORS SYSTEM PERFORMANCE
- PREVENTIVE MAINTENANCE DIAGNOSTICS

## Enhance the concept of pipe extrusion.

The investment in INDUSTRY 4.0 brings about an increased productivity and quality of the processes, and as a consequence a reduction of the overhead costs. Tecnomatic's PIPE 4.0 is the most up-to-date and state-of-the-art dedicated software in the market. INDUSTRY 4.0 allows preventive maintenance procedures and the recording of the efficiency of the machines themselves, but in particular it monitors all production activities, providing precise and timely data on order management, production phases and estimates and calculates production costs.

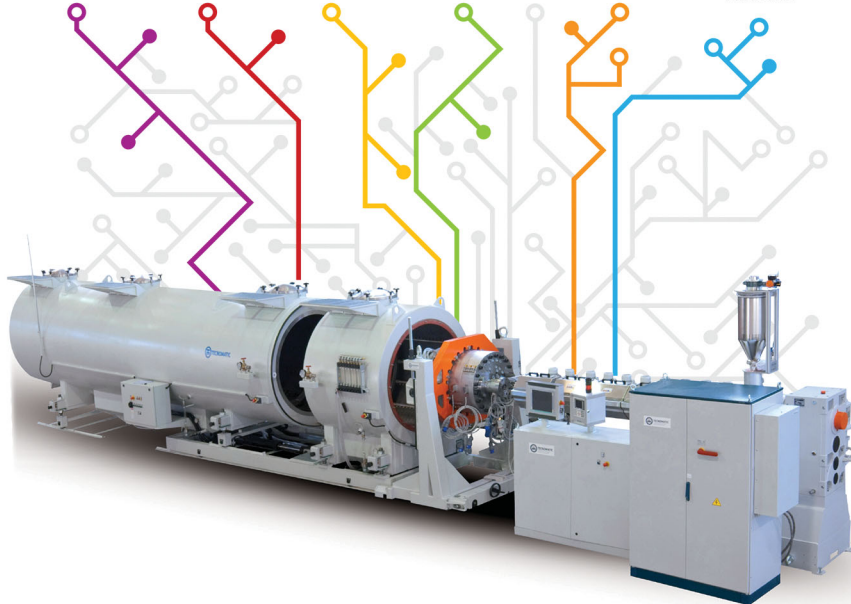

**TECNOMATIC**  
TECHNOLOGIES FOR PLASTIC PIPES PROCESSING

Tecnomatic Srl - Bergamo (Italy)  
tel. +39 035 310375 - tecnomaticsril.net

## Leadership Change

■ Maag Americas is the technology leader for melt pumps, pelletizers, pulverizers and continuous melt filters. The Maag brands „Maag Pump & Filtration Systems“, „Automatik Scheer Strand Pelletizers“, „Gala Automatik Underwater Pelletizers“, „Reduction Pulverizing Systems“ and Ettlinger provide customers exceptional performance and reliability in their respective field of applications. The many systems and solutions the MAAG portfolio offers for customers are critical to ensure high quality end products in a wide variety of markets such as medical, automotive, construction, food and packaging.

Maag announced the appointment of Martin Baumann as VP / GM for Maag Americas. “We are very happy to have Martin join our team in the USA,” says Ueli Thuerig, President Maag Group. “Martin brings a wealth of experience with him having worked previously at renowned market leaders in the plastics machinery industry.”

MAAG is well positioned for continued growth in the Americas and is a market leader in the Polymer and Plastics Industry. By having expertise in virgin polymer as well as recycled materials production, MAAG offers solutions, support and service to all markets.

“I am excited to join a global market leader, Maag Americas is known for its outstanding customer support and high product quality,” says Martin Baumann. “There is significant opportunity to further leverage our global footprint to accelerate product development, enhance the customer experience and deepen our relationships with customers as well as driving operational improvements.”



*Martin Baumann,  
VP / GM Maag Americas*

rience and deepen our relationships with customers as well as driving operational improvements.”

The market for plastics processing equipment is constantly changing, suppliers need to adapt, innovate and reliably produce products to fulfill these requirements. Visit Maag at the K-Show in Duesseldorf, Germany from October 16-23 to experience the Maag Brands coming together to provide integrated solutions. Maag will be displaying the entire product portfolio in one booth, showcasing Maags expertise across virgin polymer production, compounding, extraction, mechanical recycling and industrial applications.

**K 2019: Hall 9, Booth A04**

■ Maag  
[www.maag.com](http://www.maag.com)

## Plastic Industry Veteran Mirek Planeta retires

■ Plastic film and sheet extrusion machinery supplier Macro Engineering and Technology announced the retirement of its founder Mirek Planeta effective June 14, 2019.

Planeta established Macro just outside of Toronto, Canada in 1978. The initial focus of the company was improving air ring design, leading to the invention of the dual lip air ring. He was always leading the company through growth, improvements, and tremendous change which made it possible to expand from a component supplier to offering complete extrusion systems and in the process became a global industry



*Founder of Macro  
Engineering and  
Technology  
Mirek Planeta*

leader in high barrier and specialty film processing technology. Today Macro has equipment installed and operating in over 40 countries worldwide.

“Mirek, we want to congratulate you on an absolutely remarkable career”, said Macro’s President and CEO Jim Stobie at the company’s retirement event. “You have made an enormous contribution to the plastic industry here in Canada and globally. You are admired and respected for your creativity and vision by friends, customers and competitors all over the world.” Mirek was awarded with a company designed “Mirek-Pack coextrusion die” model.

In a very emotional speech, Planeta spoke about his journey from 1978 until today, and thanked all Macro employees, especially those who started with him around 40 years ago.

■ Macro Engineering & Technology Inc.  
[www.macroeng.com](http://www.macroeng.com)



## Automation Company Inspires and Motivates Students to Pursue Science/Technology Careers

■ CBW Automation, a leading U.S. supplier of robots and automation solutions for the plastics industry, has partnered with a local Fort Collins high school robotics team and provided financial support and mentoring to guide and motivate students in STEM (Science, Technology, Engineering, and Math) career fields.

Students from Fossil Ridge High School have worked closely with technical volunteers from CBW Automation for the last two years, competing in the nationally-recognized FIRST (For Inspiration and Recognition of Science and Technology) robotics competition. FIRST was founded in 1989 to inspire and



educate young people in STEM fields while building life skills through a mentor-based teaching system. The local team, named FIRST team 4388 Ridgebotics, was recently successful in two competitions, including an eighth-place in a regional competition in Utah.

“This is our way of giving back to the community,” said Shiloh Wood, a CBW Automation project engineer and lead volunteer. “This program enables students to spend their time profitably and encourages and motivates them to pursue technical instruction and possible careers in a STEM-related field.”

The totally student-led endeavor consists not only of designing, building, and programming a robot to complete a mission, but also learning and understanding business tasks such as fundraising, marketing, and budgeting. In the fall season, student leaders train incoming students and the team prepares for the upcoming competition by building a smaller practice robot to test new components and designs. In January, students are assigned the design parameters for the project and have six weeks to design and build a robot.

■ CBW Automation  
www.cbwautomation.com

## Phosphite Antioxidant now has Broader Approval for Food-Contact Applications

■ SI Group, a leading global developer and manufacturer of performance additives, process solutions, pharmaceuticals and chemical intermediates, announced that its phosphite antioxidant ULTRANOX™ 626 has been granted an extension of existing approvals by the U.S. Food & Drug Administration (FDA) for use as a food contact substance in polypropylene homopolymers and copolymers under Conditions of Use A through H as listed in FCN 1988.

ULTRANOX™ 626 is a high-performance organophosphite antioxidant designed for demanding applications in homopolymers and copolymers of propylene and ethylene, as well as for elastomers and engineering compounds, particularly for applications where excellent color stability is required. The recent extension permits the use of ULTRANOX™ 626 in a wide range of polypropylene food packaging and other food-contact applications.

“We will continue to invest in the future of polymer additives that meet growing safety requirements,” said Rich Prezioti, SVP and President, Additives. ULTRANOX™ 626 has the



highest phosphorous concentration among our secondary antioxidants; therefore, it can be used at lower concentrations, resulting in low migration and low volatile-content plastics. These features align with the current requirements of responsible food packaging producers and brand owners. This approval is effective as of June 25, 2019 and is specific to the material manufactured at SI Group’s Morgantown, WV facility.

■ SI Group  
www.siigroup.com

## New 800 Series Hybrid Extrusion Tooling

■ Guill announced the introduction of a new version of its popular 800 series, known as 800 Series Hybrid. In some extrusion applications that utilize crossheads and inlines, layers of the exact same material are applied multiple times, using a single die. This method is used to reduce the propensity for errors caused by gels breaking through a thin wall, weld lines, inconsistent wall thickness, plus material and process variations. Additional errors include difficult-to-process materials and demanding applications where there is zero fault tolerance.

Seeking to design the next generation multi-layer die to overcome these challenges, the engineers at Guill looked for a way to incorporate this technology into an updated version



of the 800 Series. This led to the creation of the 800 Series Hybrid. The inherent benefits of the 800 Series are retained, including compact design, low residence time and a common deflector bore that eliminates tolerance stack up. The challenge was to create a hybrid design that incorporates the benefits of layer overlapping, while reducing unnecessary complexity and making the technology more cost-affordable for customers. This was achieved by overlapping layers in each semi-deflector, using a single cone. The highly efficient design of the 800 Series Hybrid reduces cost and size, as opposed to other methods of overlapping layers.

Essential benefits of the 800 Series Hybrid include eliminating weld lines in materials through patented overlapping technology, producing a more consistent finished product; reduced sensitivity to changes in viscosity; reduced sensitivity to changes in line speed; myriad material and multi-layer application possibilities; works in all tubing and jacketing applications with a wide range of materials; low residence time; compact design and a low tolerance stack-up error factor, all resulting in improved concentricity.

The 800 Series Hybrid extrusion tool greatly reduces stagnation, because overlapping layers are more inherently balanced than single layers and also because each semi-deflector is "tuned to flush." Conventional deflectors must simultaneously achieve a balance between flushing, balancing and eliminating the weld line. There is less difference between the slowest moving material and the fastest moving material in the deflector channels, thus making the viscosity more consistent in the deflector.

■ Guill Tool & Engineering Co., Inc.  
www.guill.com

## Focused Sale of Industrial Resin Business announced

■ SI Group, a leading global developer and manufacturer of performance additives, process solutions, pharmaceuticals and chemical intermediates, announced an agreement to sell the majority of its global industrial resin businesses and its Brazilian specialty business to ASK Chemicals, a portfolio company of private equity firm, Rhône Group, LLC.

The transaction includes SI Group's industrial resins products and associated manufacturing sites in Rio Claro, Brazil; Ranjangaon, India; and Johannesburg and Durban, South Africa, as well as licensed technology and multiple tolling agreements globally. ASK Chemicals, headquartered in Hilden, Germany, is a market leader in the foundry materials sector and manufactures binders, coatings, feeders, filters and release agents, as well as metallurgical products including inoculants, inoculation wires and master alloys for iron casting. The deal is expected to close later this year.

"While the industrial resins business has long been a part of the SI Group portfolio, the decision to sell this portion of the business affords us the opportunity to reshape our portfolio," said David Bradley, President & CEO of SI Group. "The sale of this business provides proprietary technology and know-how in the industrial resins business to ASK while realigning our focus around performance additives."

SI Group will carve out related businesses at these four sites, including the manufacture of global rubber & adhesives and oilfield products, as well as foundry products in Brazil, and will operate tolling agreements with ASK.

■ SI GROUP  
www.siigroup.com

## Personal Touch secures Order

■ When Puerto Rican converter Alco High-Tech Plastics needed a new Corona system for the extrusion side of its business in 2018, it turned to Danish manufacturer Vetaphone. Three months on, it added a second Vetaphone system because of the 'very positive' experience it had enjoyed with the first installation, according to Operational Manager Gilberto Nieves.

Founded by Maria Nieves in 1997 in Corozal, some 25 miles from the island's capital San Juan, Alco has grown from its original investment of \$1.5m and 22 people to be the island's leading manufacturer of high quality flexible packaging, all produced under the guidance of the FDA's 'Good Manufacturing Practices'. Products produced include printed and laminated bags, films, stand-up pouches, zip lock products, and more recently flexo printed labels.

The majority of the company's output is for local consumption, but a growing export business sees Alco products finding markets as far away as Spain and India, as well as more locally in the USA, Dominican Republic and Mexico. But fundamental to all the packaging is the company's capacity for extrusion, with currently seven lines in operation from a variety of manufacturers, making it the largest extruder on the island.

When the time came to install a new extruder, Alco looked long and hard at what ancillary technology was available, as Gilberto Nieves explained: "We had always used American Corona systems before, but poor after sales service and spare parts availability prompted us to invite competitive quotes. For whatever reason, our existing supplier showed little interest, whereas Vetaphone took the time and trouble to visit us in Corozal and engage in discussions about how their technology could improve our efficiency."

That commitment was sufficient to earn the first order, for a two-sided 1.4m wide VE2B-A Corona system, that was fitted to a Carnevalli line in December 2018. "The commissioning went really smoothly – everything arrived in the one box and assembly was straightforward, since which time it's been working really well, and incidentally uses significantly less electrical power for



the same Corona output," he added. Vetaphone's B models are designed for the slower extrusion process and this 1kW system is ideally suited to Alco's production with its 25m/min operating speed. It also features segmented electrodes lane treating, built-in guide rollers and QC quick change electrode cassettes.

Also drawing praise is Vetaphone's modular generator, which offers easy maintenance and repair, and the first-class service support that Alco says it has received from The Works Corporation, who represent Vetaphone's service interests in North America, and who keep a stock of parts at their headquarters in Wisconsin.

In February 2019, a second Vetaphone Corona system was installed, also fitted to a Carnevalli extruder, but this time to a machine that had extremely limited headroom. This is also a VE2B-A model but this time with a 2.2m width and with 4kW power specified to run at 60m/min. Installation of this one proved more tricky, as Ted Wolski, Vetaphone's Area Sales Manager for the Americas, explained: "The limited space dictated another B model to be supplied as anything larger would just not have fitted under the roofline. It's testimony to the way we can tailor our systems to fit space limitations and other unusual requirements – that's what Vetaphone is all about."

Most recently, Alco has installed one of the latest Bobst Firenze (Gidue) eight-colour narrow web flexo lines to offer labels and shrink sleeves, and it was no surprise that it came fitted with a Vetaphone Corona unit. It typifies the company's commitment to re-invest its profits in new technology, and also into regular training of its staff to maximise on their effectiveness and improve overall production efficiency.

■ Vetaphone  
www.vetaphone.com

## Strech Film Production expanded

■ Sigma Stretch Film announced the purchase of a state-of-the-art cast stretch film production line from SML. The line will be installed at the Shelbyville facility in Kentucky and continues Sigma's strategy of both expanding production capacity and investing in the latest machine technology.

State-of-the-art winding technology will allow Sigma Stretch to produce premium-quality hand-wrap films direct off the line, helping to streamline production and further reduce customer lead times. The line also allows a quick switch between small hand-wrap rolls and large machine films, flexibility which is anticipated to reduce warehousing needs whilst improving customer response times.

Sigma Plastics, the largest privately owned film extrusion group in North America with an output of over 2 billion pounds of resin and employing over 4,500 people has a commanding position in the US markets and, with its recent investment in production in the Far East, a growing presence overseas.

The line, the third from Austrian machinery manufacturer SML, will be delivered 3rd quarter 2020. With automatic roll handling allowing sustained high outputs even on hand-wrap, production of approx. 45 million pounds of stretch film per year is expected.

■ SML Maschinengesellschaft mbH  
www.sml.at

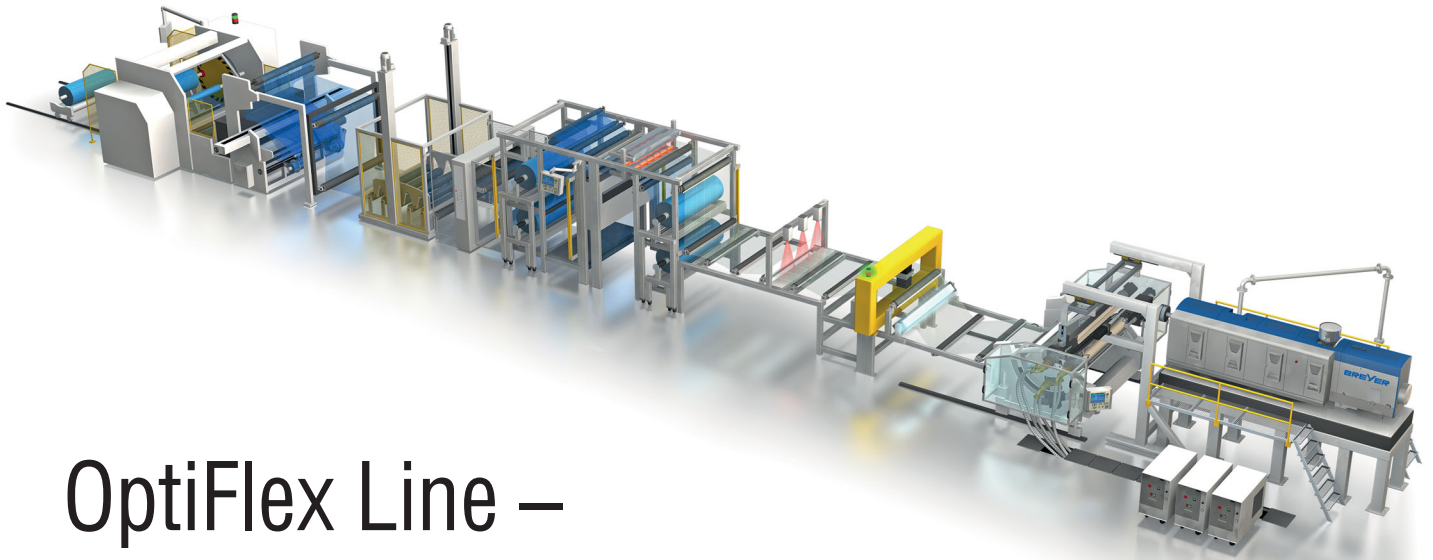

# OptiFlex Line – How Adjusting Thickness and Flatness of Film Becomes Fast&Easy

*The automotive as well as mobil phone market offers good opportunities for the application of optical films. Almost every illuminated button is made by this flexible technology. By IMD technology 3D design combined with brilliant optic and high haptic quality becomes possible. Not only one monitor is used in cars for e.g. the on board computer or navigation systems. Also video monitors in the backside of the seats are installed. Also the interior decorating styles high demand in Quality. These applications have always represented enormously high demands with respect to optical quality of the extruded film*

Producing transparent film that is as smooth and thin as possible is the desire of many processing companies whose film is used for the mentioned optical applications. However, most extrusion systems and their integrated calender machines run into problems when it comes to thicknesses of less than 500 microns.

The bending of the calender rolls and thus the thickness tolerances do not allow for a thinner production in closed roll gap mode. On top, another challenge arises: when pressing the film between the calender rolls too much, tensions are stored inside the film which are released in the later process as too much shrinkage and further more,

with a too high birefringence. The using for optical applications of that film is not anymore possible. So, the production of ultra-thin, low-tension films of high optical quality in particular, is quickly separating the men from the boys. With the BREYER OptiFlex line producers of Polycarbonate and PMMA (as single layer or coextruded multilayer) film are staying always flexible and ahead.

Both side polished, mat and structured film with optical properties can be produced on a single line. BREYER film extrusion systems today offer especially for the thickness range of 50 to 1000  $\mu\text{m}$  with excellent achievable tolerances.

## **To keep the film flat**

Especially flat applications require a well flatness of the film. By the BREYER calender with its slewable third calender roll is not anymore a matter of many minutes. By this feature the residential time of the film around the center calender roll is influenced. During running condition the position of the third roll in relation to the center roll can be changed, resp adjusted exactly to this position where top and lower side cooling is balanced and the film becomes flat.

## **Changing quick from one thickness to another**

The BREYER gap control system includes an automatic film thickness

setting: The operation mode allows a precise and automatic adjustment of the gap, simply by changing the extrusion speed (pressure control mode). The operator changes the speed value on the touch screen in accordance with the new product thickness, and within a matter of seconds the product is set to the desired thickness. This is a clear advantage in terms of time and costs compared with conventional gap adjustment systems, which require the operator to adjust the speed separately, after the gap adjustments have been implemented.

#### How to avoid inside stress

By the same system the operator can change between distance control (setting the thickness) and pressure control mode on the fly. The pressure control mode allows to set a specific gap pressure inside the roll gap. A too high gap pressure generates too much stress inside the film. A disadvantage for optical film quality as well as for the later thermoforming process. A too much shrinkage might be occur and leads to waste of the produced parts.

In conclusion with a FSR system (flexible shell roll) low pressure can be applied to the film. In spite of the low pressure and due to the special FSR technology the film surface becomes perfect polished.

#### 3 in one

The calender machine offers the production of three different kind of film in one:

Both side polished surfaces, polished/embossed and embossed/embossed. In this way the machine is highly flexible. Thanks of the quick-exchanges device of the first and center calender roll, the machine can be fast converted for different type of film.



K 2019: Hall 16, Booth C18

**BREYER GmbH**  
Bohlinger Str. 27, 78224  
Singen, Germany  
www.breyer-extr.com

## High precision dosing technology for broad application

### NEW GDS 5 Gravimetric dosing system

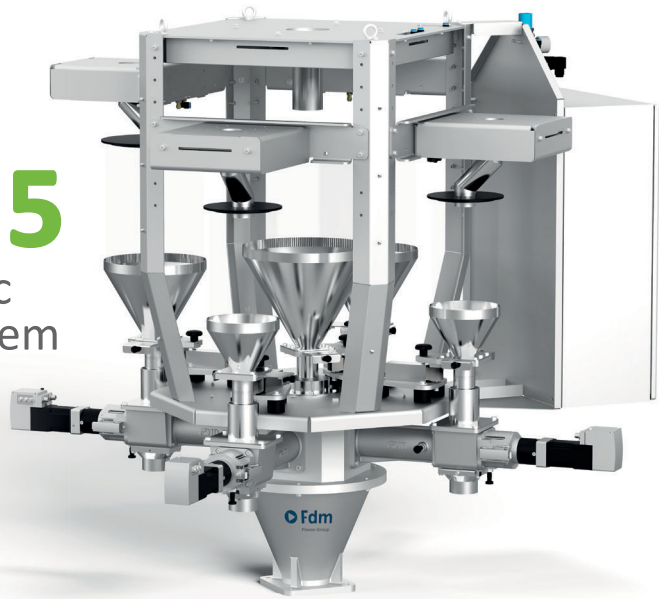

- Throughput control and gravimetric blending systems
- Max. output to 600 kg/h
- Continuous gravimetric systems using the "loss-in-weight" principle ensure
- Pellet, regrind and additive
- Total 5 components
- To 4 auxiliary components with dosing screws
- PLC Control with HMI 12"

\ [fdm.piovan.com](http://fdm.piovan.com)

**Fdm**  
Piovan Group

*The Upper Austrian "MAS Maschinen- und Anlagenbau Schulz GmbH", inventor and established supplier of the conical co-rotating twin-screw extruder system, will introduce two new innovations for the compounding and the recycling technology beyond the twin-screw extrusion technology at the K 2019 on booth 9 / D42*

# Innovations for Compounding and Recycling

The central position in the MAS range continues to be the conical twin-screw extrusion system with co-rotating screws introduced in 2007. Its peculiarities and the advantages derived from it are the gentle plasticizing, even conveying and good homogenization at high throughput. Measurements of the physical extrudate characteristics show that they are maximally preserved compared to the input qualities when processing on MAS extruders, which is particularly important for recycling applications. Due to the large cross-section of the feed opening and the resulting feed volume, the MAS extruders are particularly suitable for materials with low bulk density, such as recycled flakes, but also for use in compounding technology. An important advantage for plastics recycling is the high plasticization quality, which provides the ideal conditions for efficient removal of foreign matter through filtering and degassing.

The MAS extruders are available in six sizes in an output range of 10 to more than 2,000 kg/h (Picture 1). Their conical screws have a modular structure and thus can be adapt-

*Picture 2: MAS-high-quality compounding configuration consisting of a conical co-rotating twin-screw extruder as additive conveyor and a side-feeding single-screw extruder for polymer addition*



*Picture 1: The conical co-rotating twin-screw extruders are available in 6 size stages with a throughput ranging from 10 to over 2,000 kg / h (All pictures: MAS)*

ed quickly and easily to the respective application. Another advantage of the MAS extruder is the plasticization with a largely constant melt pressure, setting the precondition for not requiring the use of melt pumps in almost all regranulation applications.

## **New innovation for compounding glass or carbon fibers**

As mentioned above, one of the most important advantages of the conical MAS extruder is the large feed opening in combination with the good feed behavior of the co-rotating screw system. This provides the best conditions for an efficient intake of additives like stabilizers, fillers but also fibrous materials. In order to make the best possible use of this advantage, MAS has further developed the machine concept for compounding. It supplements the MAS extruder by a single-screw extruder in sidefeeder configuration (Picture 2). Its task is to meter in the main polymer, while the large-scale feed zone of the MAS extruder is left to the task of additives. This configuration saves the use of individual sidefeeder along the extrusion line compared to conventional systems. The advantages are an earlier achievement of a good mixing quality and ultimately a higher compound homogeneity. These advantages are complemented by the above-mentioned basic MAS-advantage of very gentle plasticization, as a result of which the additives, in particular glass or carbon fibers, are subjected to only minimal mechanical stress. Their length and thus their reinforcing effect remain maximum. The system has successfully passed its test in trial operation and will be open for series application from K 2019 on. More information is available at the MAS-booth.

## **Cascade retrofit package for recycling extruders to increase throughput, quality and profit**

The second MAS-fair-novelty is a retrofit package for recycling lines to increase the process performance and quality, especially for the processing of PE-film-flakes. It is a combi-

nation of the proven MAS-CDF disc filter and a specifically developed and patented MAS single-screw degassing extruder (Picture 3). This allows existing single- or twin-screw extruders to be upgraded to a cascade extrusion line. The MAS cascade package is more than just a retrofit option. It also offers a procedural innovation. It is the patented division of the melt stream coming from the filter into a series of individual streams in a multi-channel melt distribution manifold, through which the polymer melt coming from the initial extruder and after having passed the filter is fed into the degassing zone of the single-screw extruder (Picture 4). The division into individual streams has the effect that the polymer mixture can be degassed more efficiently and thus has a more homogeneous material density. Several production applications with PE and PP materials have shown that after retrofitting the cascade package the throughput of the recycling line raises by 40 to 50 percent over the initial constellation. Concurrent, the

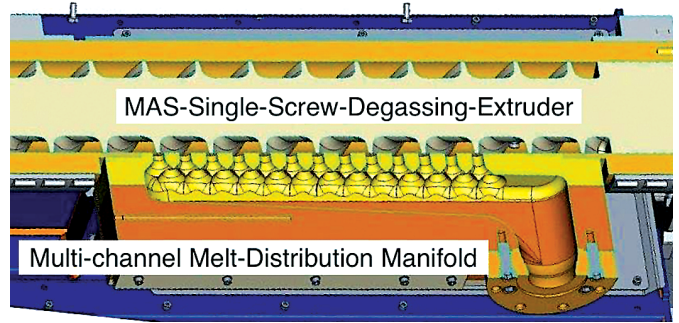

Picture 4: Cross section through the "multi-channel melt-feed manifold" in which the melt stream coming from the melt filter is divided into individual streams in the direction of the degassing zone of the cascade extruder

Picture 3: MAS cascade retrofit package consisting of MAS-CDF-disc-melt-filter with subsequent melt line to a multi-channel melt-feed-manifold and MAS single-screw degassing extruder

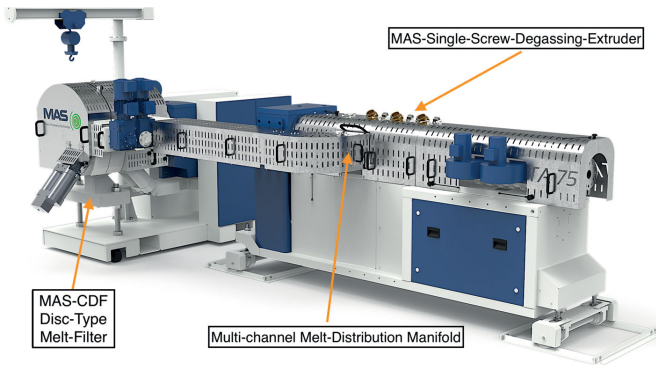

more homogeneous extrudate increased the bulk density of the regenerated material by up to 15 percent. This in turn has the consequence that the weight amount per transport unit increases, whereby the transport volume and the associated transport costs decrease and thus contribute to a higher added value.

All in all, the MAS cascade retrofit package is an efficient way to increase the performance of existing recycling plants which is economically complemented by a short return on invest.



K 2019: Hall 9, Booth D42

MAS Maschinen- und Anlagenbau Schulz GmbH  
A-4055 Pucking, Österreich  
www.mas-austria.com

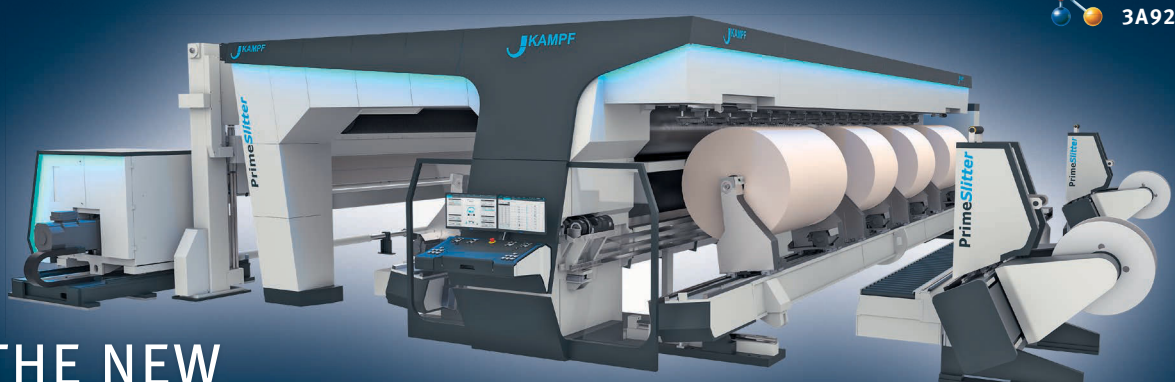



THE NEW

PrimeSlitter

create

Transformation



3A92

www.kampf.de

# Coated Melt Pumps ensure Product Quality

## Novel amorphous surface prevents material build-up and deposits

*Whether uniform colouring in sheet and profile extrusion or transparency in film extrusion, there is a rising demand toward the quality of products in plastics processing. Homogeneity of the melt and dimensional stability of the final product are of high importance. In this context, the even and constant delivery of the melt pump plays an important role. To ensure optimum product quality, the Swiss company Eprotec Extrusion Technology AG has introduced a novel melt pump to the market. Amorphous surfaces of the pump prevent possible material build-up, allow faster colour changes and reduce wear to a minimum*

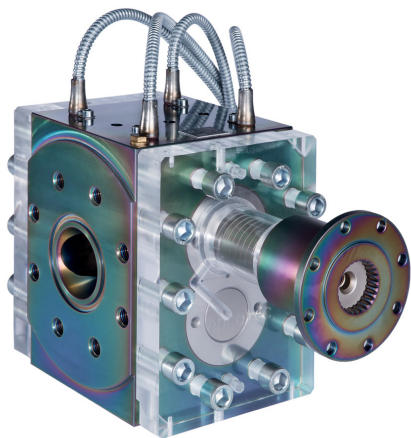

### Deposits can significantly reduce product quality

Deposits within the melt pump, caused by dwell time, chemical reactions or

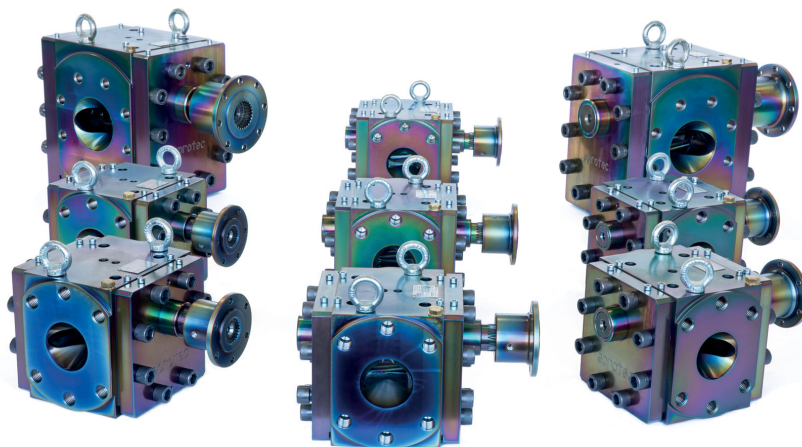

dead zones, can significantly reduce product quality and lead to higher reject rates and longer down times. In addition, colour pigments in masterbatches, fillers or contaminated recycling materials increase wear and thus shorten the service life.

Peter Fischer, co-owner of Eprotec Extrusion Technology, confirms: "During the extrusion of sheets made of PC, PMMA or the compounding of TPE, our pumps must meet the highest standards. The manufacturer expects process stability from us. Already 15 years ago, we introduced smaller diameter flow channels (product holes) in our melt-X melt pumps. The goal was to achieve a higher flow velocity and thus to prevent melt adhesion. The transitional areas between the housing bore and the bushings have also been optimized to avoid dead zones. A high level of self-cleaning was the main focus in our development. In particular, the gentle and complete squeezing of each individual tooth gap guarantees success and process stability."

### Eprotec is breaking new ground

With Dreistegen GmbH in Monschau, Germany, a specialist for surface treatment in plastics processing, Eprotec has found a competent partner. Dreistegen assists in finding solutions for even

higher customer demands and for the continuous development of new products. An oxide hard coating applied by means of PVD / CVD technology offers decisive advantages: The amorphous, non-polar surface prevents chemical build-up and deposit formation. The wall adhesion is reduced which in turn results in improved flow properties. An almost dense surface reduces the tendency to corrosion. The high hardness of more than 2,300 HV offers very good wear protection for demanding melt pump applications.

### Cleaning time reduced by 1/3

Customers of Eprotec confirm that the cleaning time, thanks to the new coating of the melt-X melt pumps, is reduced by 1/3. Polymers are easy to wipe off. Colour change times are again significantly reduced, thus reducing polymer loss. In addition, the maintenance intervals are extended for applications which are subject to significant wear.



2019  
16-23 October  
Düsseldorf  
Germany

K 2019: Hall 11, Booth C73

Eprotec Extrusion Technology AG  
Pumpwerkstr. 23, 8105 Regensdorf,  
Switzerland  
[www.eprotec-extrusion.com](http://www.eprotec-extrusion.com)





basco-masterbatch.com

We make the world colourful®



**High quality pigment and additive masterbatches**  
white and black / colour / additives / liquid colours / special compounds

**BARS-2** THE SCIENTIFIC  
AND PRODUCTION COMPANY

Over 25 years of experience in MB production  
22000 mt annual capacity  
ISO 9001-2015

**WE ARE LOOKING FOR THE PARTNERS  
ALL OVER THE WORLD**

Head office: Optikov str., 4, Saint Petersburg, Russia  
Tel. + 7 812 346 78 82 e-mail: bars2@bars2.com

Machine data processing

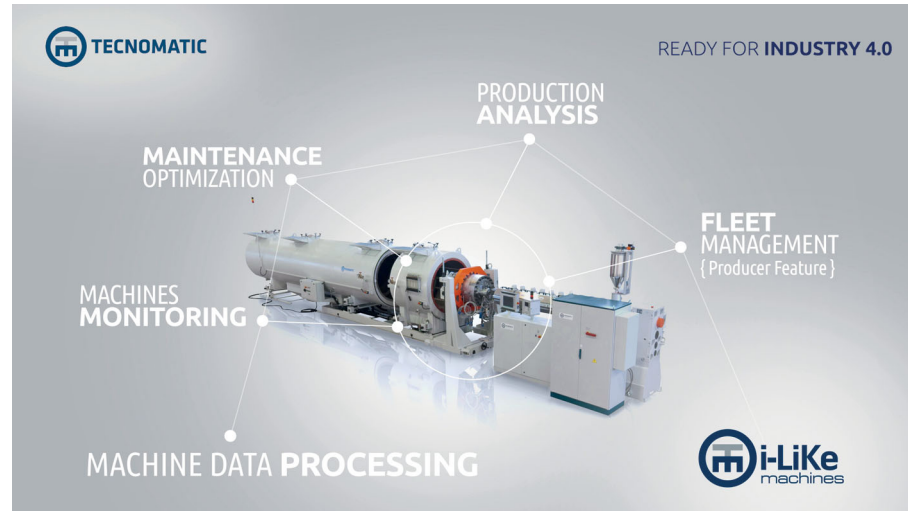

# Higher Performance and Productivity of the Pipe Extrusion Plants Thanks to Industry 4.0 Development

*Pipe manufacturers are more and more oriented towards cost efficiency and energy saving, but always aiming at the best performance and output rate achievable for their pipe extrusion lines. Renowned as a top producer of machinery for the production of plastic pipes, with over than 40 years of experience in this sector, Tecnomatic will exhibit innovative solutions for pipe extrusion at this years K-show, to assist customers not only by supplying extruders and die-heads, but also by providing complete production systems for a business which is getting increasingly demanding*



Production analysis

At K-SHOW 2019, Tecnomatic will exhibit one extruder and two die-heads, part of its innovative range of products and will introduce the customers to the current industrial revolution, known as Industry 4.0

#### Focus on Industry 4.0

An innovation which will change the future and it's already changing the present is definitely "INDUSTRY 4.0", which is becoming increasingly important and is involving more and more factories. Industry 4.0 plays a strategic role in coordinating, synchronizing and analyzing the machinery's process, as well as supplying very important data to the human operators. Therefore the production process will be more accurate and will make the human operator's work easier.

TECNOMATIC at K-SHOW will introduce customers to its system aimed at supporting the new digital industrial revolution, providing to the plastic pipes manufacturers a complete and integrated portfolio of products, solutions, industrial software and automation technologies.

The system provides a simple user-friendly program for the networking of extrusion pipes lines. Via the machine's EPC (Extrusion Process Control) system, several machines and peripherals are connected and linked together to be operated via a uniform user interface, which enables interaction between the individual appliances. In this way, the entire manufacturing process, including material feeding, temperature control and synchronisation is coordinated and tracked. Another important point is having all parameters centrally recorded and monitored. The system allows, not only to carry out energy monitoring, but to convert numbers and data into valuable information on the processes within the line. This enables optimal analysis of a line's performance.

From the relevant key performance indicators (KPI) for shift supervisors up to the clear presentation of the line performance for the management.

Perfectly in line with the concept of "smart factory" of the Industry 4.0, all data, including preventive maintenance and service parameters or alarms can be monitored via internet or intranet, to Pc, servers or to mobile devices. The investment on Industry 4.0 brings about many advantages as:

- Higher flexibility and efficiency of the extrusion line through a reduced set-up period, reducing errors and downtime



**SIKORA**  
Technology To Perfection

## Free material testing - LIVE at K 2019!

You would like to learn more about our inspection system, if it is suitable for your plastic granulate and what advantages it may offer? Simply test it.

Visit us at the K 2019 at booth 10 H21. We inspect and analyze up to three granulate samples with the **PURITY CONCEPT V** for free. The results are either discussed directly at our exhibition booth or confidentially sent to you.

For more information, visit [www.sikora.net/live-material-test](http://www.sikora.net/live-material-test)



Visit us from October 16-23  
at K 2019, Düsseldorf,  
Germany, booth 10 H21.

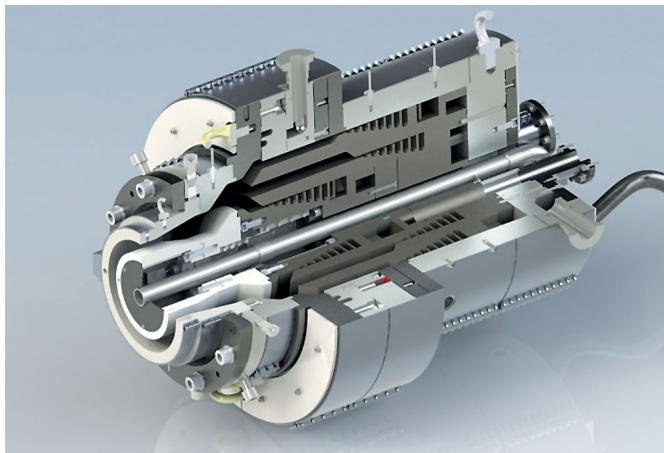

*Four layers pipe-head*

- Possibility of big data collection and analysis to optimize the processes

The above are just some of the many pros of having extrusion plants, which are operating with Industry 4.0 technology and therefore TECNOMATIC is focusing and investing on it. This will enable TECNOMATIC to supply its clients with the most efficient extrusion lines available in the market.

#### **Extruders & Die-Heads**

Further to an extruder of the ZEPHYR series Tecnomatic will also display die-heads of the VENUS series, to produce PP-R pipes with fiberglass up to 250 mm, and of the VENUS COAT series for the coating of PE or metal pipes with protective or functional layers.

ZEPHYR is the most performing extruder manufactured by Tecnomatic, it features an array of advanced technical solutions which makes it ideal and suitable for pipe producers looking for even more focused energy saving machines, offering extreme output performance at lower melt temperatures. The innovation spans the entire extruder and includes new spiral grooved bush, screw and motors.

Pipe extrusion is highly dependent on electricity and most of the energy usage is in operating the extruder itself. The Zephyr series has been designed by focusing on this as a priority, in fact the extruders of this line feature increased screw length and AC water-cooled motors, to ensure same output of bigger size extruders but with a better energy efficiency.

The new feed bush ensures minor friction, commonly generated by raw material transport, with subsequent increasing of the specific and total throughput. The further development in screw design, with optimization and enhancement of torque and shearing elements, have improved the output but have also led to process the material at lower melt temperatures.

In a market, which is always more and more looking for highly innovative development, with respect to the grow-

ing improvement of material properties, single-layer pipes are not always able to fulfill the necessary requirements. Tecnomatic has well interpreted these customer needs and has developed, on the basis of the VENUS concept, a full range of die-heads for the production of 2, 3 or 4 layers polyolefin pipes even in big size.

The VENUS MULTI pipe heads have implemented important technological features in order to reach the best pipes processing and to fit a wide range of materials at very high output. The spiral geometry has been especially optimized for the latest generation of PE and PP raw materials, while length, volume and pressure have been reduced. The heart of the VENUS MULTI consists of an innovative flow channels geometry, which has been calculated by considering the current raw material. This geometry assures the same behaviour for pressure and distribution of the melt, in every pipe head of the range, also at very high output rate.

The new feeding system of the spiral channels, as well as for the matching ranges and the small die sets contributes to reduce the working pressure. This influences remarkably energy consumption during extrusion taking into account that approximately 5 to 10% of the extruder power is necessary for the pumping capacity. Lower pressure also results in a lower increase of the melt temperature and with lower residence times assuring improved pipe's characteristics with regard to OIT (oxidation resistance) values, extra weight and thermal and shear stresses reduction.

#### **Coated Pipes**

The inherent flexibility of polyethylene has enabled a wide range of techniques, including thrust boring, directional drilling and pipe bursting, to be used to install polyethylene pipe systems. Multilayer pipe systems have been developed with the specific objectives of improving the protection of the pressure pipes during such installations and to maximize the quality of the pipe system. This pipe, with a peelable outer skin, has provided significant eco-

*Cross-head for PE coating*

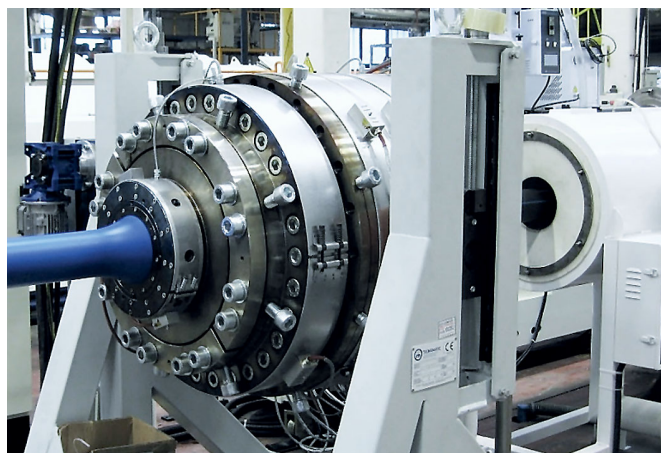

nomic and environmental benefits in water distribution pipelines and it is currently being tested and introduced into the Gas distribution networks. The jacket is made of a specially modified polypropylene material, which protects the surface of the inner pipe against potential notches and cracks generally associated with demanding installation methods such as pipe bursting or wash-boring. Even extremely deep notches in the protective jacket will not be transferred to the inner pipe when it is eventually exposed to service-related stresses. The core pipe is instead made from PE resins. The dimensions of

the core pipe match those of standard solid wall PE pipes. "Adhered" to the outer wall of the PE core pipe there is a tough skin, which is typically 0.6 to 0.7 mm thick for all current dimensions of this new multilayered pipes. The "skin" is added by a cross-head positioned before the last cooling bath.

To fulfill the needs of coated pipes production with protective layers, Tecnomatic has developed a full range of die-heads, based on spiral or radial technology suitable for both plastic or metal pipes coating with range from 5 to 800 mm, and solutions up to 4 layers. The die-heads are based on a typical spiral technology for large and single layer co-extrusion, while combined solutions with radial distributors or short path spiral are offered according to material characteristics or volume as for PA, EVOH, PVDF or adhesive bonds.

Big size steel pipe coating

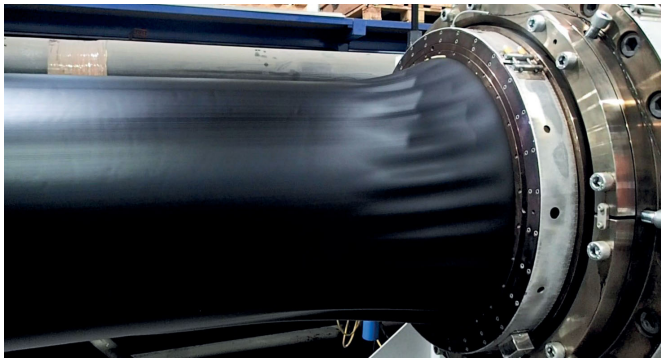

K 2019: Hall 16, Booth D05

**TECNOMATIC S.r.l.**  
Via Emilia, 4, 24052 Azzano S. Paolo (Bergamo) Italy  
[www.tecnomaticsrl.net](http://www.tecnomaticsrl.net)



# Lowering the Barriers



## Please visit us at our Booth C81 in Hall 10

**KÜNDIG CONTROL SYSTEMS**  
The Gauge Manufacturer for Film Extrusion  **SWISS MADE**

# Optimisation of the Plug Geometry in Plug Assisted Thermoforming to increase Material Efficiency

*The ever-increasing demand for sustainability of plastic products, especially in packaging, calls for increased material efficiency. Additionally to material savings in thermoformed products, the optimisation of the wall thickness distribution also minimises the required energy and reduces cycle time, as less material has to be heated or cooled. Thus the entire thermoforming process can be operated more efficiently in addition to the reduction of waste [Ede14, Mos13, TB99]*

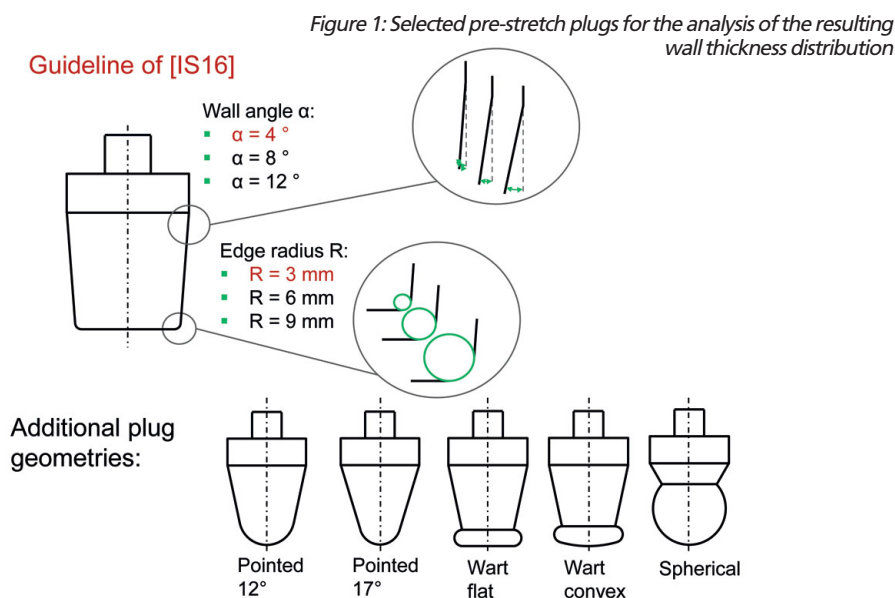

There are various process-related approaches for the adjustment of the wall thickness distribution. Temperature profiling uses the strongly temperature dependent material behaviour of plastics to induce varying stretching. Pre-stretch plugs are used for production of packaging products in negative thermoforming and pull material into areas where otherwise thin spots would occur. These thin spots are considered as the weak points of a product. Thus, they have to be taken into account when designing the thermoformed product. An adjustment of the wall thickness distribution, thickening the weak spots, leads to less over dimensioning of thick areas, better mechanical properties and overall to the application of a thinner film. Nevertheless, when using pre-stretch plugs the resulting wall thickness distribution depends strongly on the geometry of the plug, the process control as well as the plastic material [HM15, IS16].

## Design of pre-stretching plugs in thermoforming

Only a few guidelines for designing pre-stretch plugs in thermoforming exist. Furthermore, these guidelines are very general and no information is given on the resulting wall thickness distribution, as this depends on many different factors. Although there are numerous publications on plug-assisted thermoforming with the corresponding wall thickness distributions when using different plug geometries, these geometries are not directly comparable, so very few rules have been established [CHM02, HW03, IS16, MCO13, MM10, MMH06, OMS+13].

A research project at the Institute for Plastics Processing (IKV) investigates plug pre-stretching in order to analyse the influence of plug geometry on wall thickness distribution.

At the beginning a pre-stretch plug according to Schwarzmans [IS16] is constructed as shown in Figure 1. Reference is made to the corresponding literature and the pub-

lication [HB18] for the design specifications and the exact procedure. Based on this plug, the plug wall angles and the radii at the plug edge are systematically varied from the side wall to the side bottom. The 4° wall angle and the 3 mm radius correspond to the specifications of the design guideline and are based on the geometric dimensions of the negative mould and thus of the investigated cup geometry. The selected cup has an opening diameter of 60 mm, a draft angle of 4° and a depth of 40 mm. The used plug material is a syntactic foam (type: Hytac W, manufacturer: CMT Europe BV, Waalwijk/Netherlands). The selected plug geometries are shown in Figure 1.

In addition to the systematic variation of the wall angle and the radius, plugs are investigated which have larger wall angles and change tangentially to radii at the bottom of the plug. In this case flat plugs become pointed plugs. In the following plugs which have a flat area at the bottom are referred to as "flat" plugs. The other plugs are referred to as "pointed" plugs. Besides these geometrically easy describable plugs (wall angle/radius), more complex plugs are also investigated, which can no longer be described by two simple geometric properties. These so-called "warts" have an undercut which can help prevent the film from adhering to the plug. Less contact area between film and plug offer the possibility to minimise quench marks.

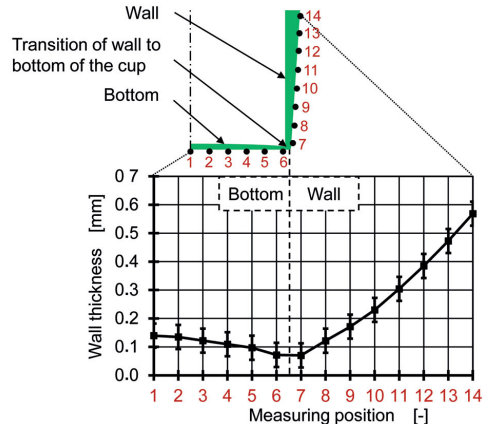

Figure 2: Measuring positions on the cup and representation of a polystyrene cup formed only with compressed air (film thickness 0.8 mm, film temperature 120 °C)

**Preliminary tests to determine the process parameters and evaluation methodology**

In order to investigate the influence of pre-stretch plugs in thermoforming, preliminary tests are carried out to determine the corresponding process parameters that enable the production of rotationally symmetrical cups. The tests are carried out on the single-station moulding machine Kiefel KD 20/25, Kiefel GmbH, Freilassing. The

Working for a better future

[www.ngr-world.com](http://www.ngr-world.com)

MEMBER OF NEXT GENERATION GROUP

**K 2019**  
 16.-23.10.2019  
 Düsseldorf - Hall 9, Booth B38

**S:GRAN SHREDDER-FEEDER-EXTRUDER COMBINATION**

**Customized recycling technology** for the plastics converting industry. It will not only satisfy, but also inspire.

Parameter	
pre-stretching distance	37.8 mm of 40 mm
plug velocity	273 mm/s
compressed air activation	after 100 % of pre-stretch distance
forming pressure	5 bar
time of forming pressure	3 s

Table 1: Processing parameters – constant parameters of plug assisted pre-stretching

varied process parameters are determined on the basis of the literature and the recommendations of the industrial advisory committee of the research project. Generally, the stretching distance, the plug speed and the time at which the compressed air is activated have a significant influence on the wall thickness distribution. Furthermore, the material, the film temperature and the plug geometry have a significant influence. The stretching distance is selected according to the design guideline. The speed of the plug is chosen as high as possible to achieve the lowest possible heat transfer in the plug as well as to minimise cycle time. The activation of compressed air has no significant influence on the wall thickness distribution with the mould technology used in these tests. Reference is also made to the literature for the exact determination and the exact settings [HB18, IS16]. The selected process parameters are summarised in Table 1.

In order to determine the influence of the plug geometry, the wall thickness is analysed along the measuring path over the entire cup cross-section. Afterwards one side is folded to the other side and average values are taken. Finally, only one half of the cup is displayed for clarity which is shown in Figure 2.

Measuring position 1 (MP 1) is located in the middle of the cup base (bottom) and MP 14 on the cups top end

Figure 4: Influence of the plug edge radius of flat plugs with constant wall angle when using PP

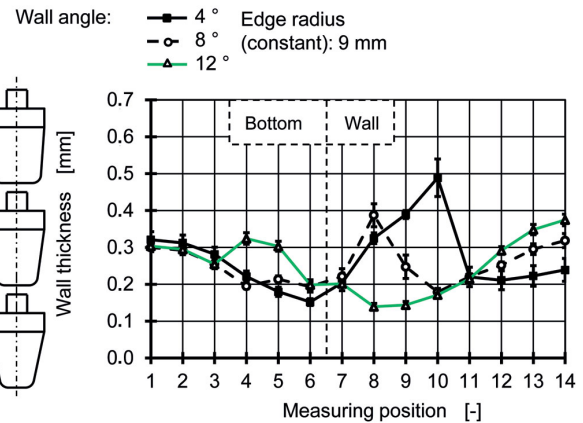
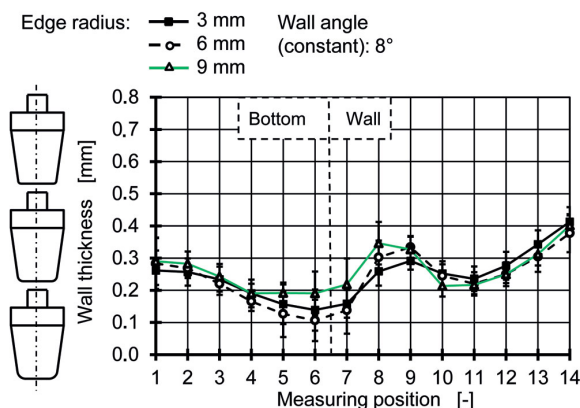

Figure 3: Influence of the plug wall angle of flat plugs with constant edge radius when using PS

near the edge of the wall. Figure 2 shows a wall thickness distribution of a cup formed without a pre-stretch plug using only compressed air. The film used is polystyrene (PS) from W.u.H. Fernholz GmbH & Co. KG, Meinerzhagen, with a thickness of 0.8 mm. The thin spot at MP 6 and MP 7 is conspicuous here. This thin spot must be specifically avoided and the material has to be less thinned out in these areas by using pre-stretch plugs.

#### Analysis of the wall thickness distribution using different pre-stretch plug geometries and film materials

Since the wall thickness distribution varies if different materials are used, polypropylene (PP) and amorphous polyethylene terephthalate (aPET) are investigated as well. These films have a thickness of 0.8 mm and are produced by W.u.H. Fernholz GmbH & Co. KG, Meinerzhagen, too. Figure 3 shows the wall thickness distribution generated by different plug geometries when using PS. The PS-film temperature is 120°C. The plug's wall angle is varied and the edge radius is kept constant at 9 mm. As the figure shows, the variation of the wall angles causes locally different wall thicknesses and the thickness distribution can be influenced significantly.

Figure 5: Influence of the plug wall angle of flat plugs with constant radius when using PP

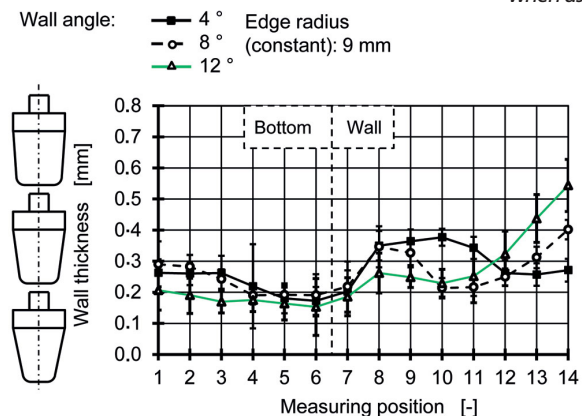



This is particularly noticeable with regard to the quenching marks which occur at MP 8 and MP 10 using plugs with a wall angle of 4° and 8°. The quenching marks can be minimised by increasing the wall angle. Due to the higher angle the material no longer gets into contact with the plug during stretching. As there is more free space between the plug and the mould the film can be stretched freely and therefore does not cool immediately by touching the plug.

In general, the minimum wall thickness can be more than doubled from 0.05 mm to 0.13 mm, depending on the plug geometry, compared to pure compressed air forming.

By increasing the radius of the plug with constant wall angle, the wall thickness distributions are influenced, but their basic distribution remains the same. The differences in the wall thickness profiles are rather small and differ only in local thickness [HB18]. Increasing the plug edge radius enables the material to be pulled more easily around the radius and thus more material is pulled out of the bottom area. The wall thickness decreases compared to smaller radii.

The wall thickness distributions determined for PS are not easily transferred to PP and aPET, since the respective stretching resistances of the materials differ. The

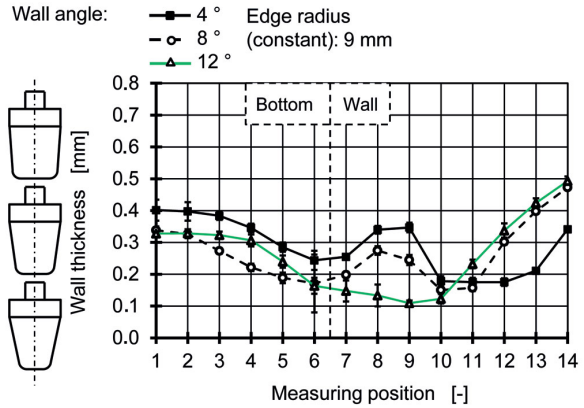

Figure 6: Influence of the plug wall angle of flat plugs with constant radius using aPET

stretching resistance influences the amount of material that will be pulled off the plug. Therefore, a change in the resistance causes a difference in the wall thickness distribution, which in turn changes the cup properties, e.g. top-load stability. Figures 4 and 5 show the resulting wall thickness distributions using PP at a film temperature of 126 °C.



**EXTRUSION GROUP**  
Local Service Global Reach





FOR BEST RESULTS IN RECYCLING:

TWIN SCREW EXTRUSION AND RINGEXTRUDER

- > High energy efficiency
- > Unmatched throughput
- > FDA/EFSA & brandowner approvals
- > Turnkey system

Attending the **K Show 2019** in Düsseldorf, Germany (Hall 14 / A34). For more information please visit [www.cpmextrusiongroup.com](http://www.cpmextrusiongroup.com)

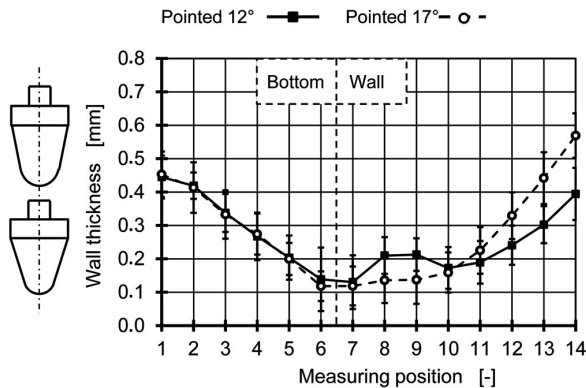

Figure 7: Influence of pointed plugs when using PP

As with PS, it can also be stated with PP that the radius has a smaller influence on the wall thickness distribution than the wall angle of the plug if all the other parameters are kept constant. Using PP, no clear statement can be made about the edge radius at a wall angle of 8°. The wall thickness distribution does not differ significantly in this case (Fig. 4). Wall angles of 4° and 12° with different radii lead to the same effects as using PS. Less material is pulled out of the bottom area, as the deflection around a small radius requires a higher force. A larger edge radius leads to less material in the bottom area of the cup. With the 8° wall angles shown, the differences are very small.

The variations of the wall angle have a greater influence on the wall thickness distribution (Fig. 5). A wall angle of 12° leads to less material in the bottom, since the material is more easily pulled around the plug compared to a 4° angle. Using pre-stretch plugs allows the wall thickness distribution to be adjusted or to be formed in general. In these trials, it is not possible to produce cups only with compressed air. The stability to evaluate the wall thickness distributions is not sufficient, because of a very high stretching and thus thinning of the film.

When aPET is used, the described effects and influences can be observed as well. Figure 6 shows an example of a variable wall angle at a film temperature of 100 °C. The effects and influences can also be observed when changing the radius and the wall thickness distribution using aPET.

The observed effects are lower than those of PS but higher than those of PP. The wall thickness profile itself is slightly influenced by the change on the plug edge radius. A change of the plug wall angle allows a change of the whole distribution and thus an adjustment of the homogeneity of the cup. The wall thickness can also be greatly increased compared to the cup produced only with compressed air. The thin area of the cups formed with compressed air only have a thickness of 0.06 mm. It can be increased up to 0.16 mm with plug assisted thermoforming. Contrary to the expectations that a further increase of the plug wall angle will lead to a further improvement in homogeneity, the wall thickness distribution is deteriorating

significantly. The use of pointed plugs results in less material being pulled out of the bottom area, which makes it particularly thick compared to the wall thicknesses when flat plugs are used. Due to the larger freely stretchable area, different stretching resistances occur. Since more material is available for free stretching (without plug contact), the local stretching resistances of the film decrease and less material is pulled out of the bottom. The adhesive forces on the plug are higher than the forces required for stretching the freely stretchable areas. Figure 7 shows the wall thickness distribution of two pointed plugs for PP at a film temperature of 126 °C. The qualitative wall thickness distributions are the same when using PP and aPET. Large wall thicknesses in the bottom, which decrease towards the transition between bottom and wall are visible. Then the wall thickness increases again. In general the wall thicknesses can be improved (0.11 mm), but only to a lesser extent compared to the other plugs.

#### Analysis of top-load stability

Although the wall thickness distributions that are shown here give a good impression of the wall thicknesses as a function of the various measuring positions, they are not suitable for conclusions about the homogeneity of the wall thickness distribution. In order to describe the homogeneity of the wall thickness distributions equation 1 is defined. A cup is particularly homogeneous if the maximum wall thickness difference  $\Delta s$  of the thickest ( $s_{max}$ ) and thinnest ( $s_{min}$ ) wall thickness is low.

$$\Delta d = d_{max} - d_{min} \text{ (eq. 1)}$$

The homogeneity can now be compared with the top-load stability of the cups. Thus, it is possible to draw conclusions about the possible load on the cups in relation to the homogeneity. The top-load stability is determined by compression tests on a Zwick Z10, Zwick Roell GmbH & Co. KG, Ulm, Germany. The maximum wall thickness differences and the top-load determined as a function of different plug geometries are shown in Figure 8 using PP cups as examples (film temperature 126 °C). The first number describes the wall angle of the plug, the second number describes the edge radius, e.g. 4°R6 is a plug with a wall angle of 4° and a radius of 6 mm.

Figure 8: Maximum wall thickness differences (homogeneity) and associated top-load as a function of various plug geometries

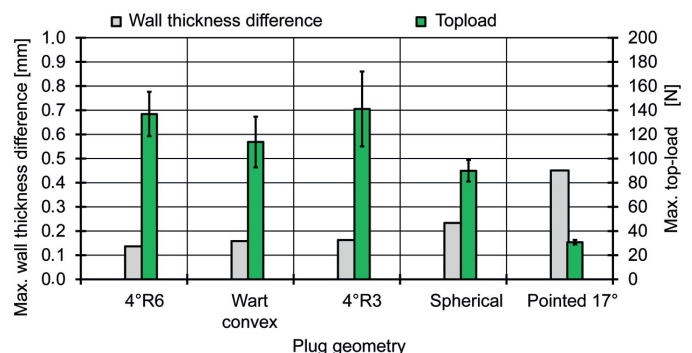

Particularly homogeneous wall thickness distributions, i.e. those with a small wall thickness difference, can withstand higher top-loads. Thin spots are thickened and thus lead to more stability. Particularly inhomogeneous wall thickness distributions, such as those produced by a pointed plug with a large wall angle, have poor top-load properties because they have thinner wall thicknesses in the wall and transition area. With the selected cup geometry, the assumption that more homogeneous wall thickness distributions lead to better mechanical properties of the cups in top-load tests can be confirmed. The tendency that better top-load stability can be achieved with more homogeneous wall thickness distributions can also be confirmed with other film materials and film temperatures.

### Conclusion & outlook

It can be shown that the plug edge radius has comparatively little influence on the resulting wall thickness distribution. The plug wall angle, on the other hand, enables the adjustment and homogenisation of the wall thickness distribution. Nevertheless, it is not possible to select a plug in advance in order to predict the most homogeneous wall thickness distribution directly. The wall thickness distribution differs enormously depending on the film material and the temperature of the film due to the greatly changed stretching resistances. Only pointed plugs lead to a poor wall thickness distribution for all materials and are therefore not suitable for homogenisation, as they lead to a particularly large amount of material in the bottom of the investigated cup geometry.

The top-load properties can be increased for all cups manufactured with pre-stretching plugs, with the exception of the pointed plugs. Particularly homogeneous wall thickness distributions also exhibit the best mechanical properties and top-load stability. In retrospect, the film thickness can be reduced if the material is specifically stretched through the use of pre-stretching plugs compared to compressed air forming. Thin or weak areas can be prevented. In further trials it has to be investigated to what extent the results can be transferred to larger or deeper cup geometries.

### Acknowledgements

The research project (19342 N) of the Forschungsvereinigung Kunststoffverarbeitung has been sponsored as part of the „industrielle Gemeinschaftsforschung und -entwicklung (IGF)“ by the German Bundesministerium für Wirtschaft und Energie (BMWi) due to an enactment of the German Bundestag through the AiF. We would like to extend our thanks to all organisations mentioned. Furthermore we would like to thank Kiefel GmbH, Freilassing, Marbach Werkzeugbau GmbH, Heilbronn, Kiefer Werkzeugbau GmbH, Schwaigern, and W.u.H. Fernholz GmbH & Co.KG, Meinerzhagen for the provision of equipment, mould technology and test materials.

### The Authors

Univ.-Prof. Dr.-Ing. Christian Hopmann;  
Dennis Balcerowiak, M.Sc.  
Institut for Plastics Processing at RWTH Aachen University

### Literature

- [CHM02] COLLINS, P.; HARKIN-JONES, E. M. A.; MARTIN, P. J.: The Role of Tool/Sheet Contact in Plug-assisted Thermoforming. *International Polymer Processing* 17 (2002) 4, pp. 361 – 369
- [Ede14] EDERLEH, L.: Simulative and Experimental Research on the Forming Behaviour of Thermoplastics during Thermoforming. RWTH Aachen, Ph.D. Thesis, 2014, ISBN: 978-3-95886-026-1
- [HB18] HOPMANN, CH.; BALCEROWIAK, D.: Der Schreckmarke den Kampf angesagt. *Kunststoffe* 118 (2018) 11, pp. 81-85
- [HM15] HOPMANN, CH.; MICHAELI, W.: Einführung in die Kunststoffverarbeitung. München: Carl Hanser Verlag, 2015
- [HW03] HABERSTROH, E.; WIRTZ, J.: Helfer für die Becherformung. *Kunststoffe* 93 (2003) 12, pp. 52-55
- [IS16] ILLIG, A.; SCHWARZMANN, P.: Thermoformen in der Praxis. München, Wien: Carl Hanser Verlag, 2008
- [MCO13] MARTIN, P.J.; CHOO, H.L.; O'CONNOR, C.P.K.: Measurement & Modelling of Slip During Plug-Assisted Thermoforming. *Key Engineering Materials*, (2013) 504-506, pp. 1105-1110
- [MM10] MCCOOL, R.; MARTIN, P.J.: The Role of Process Parameters in Determining Wall Thickness Distribution in Plug-Assisted Thermoforming. *Polymer Engineering and Science*, 10 (2010) 50, pp.1923-1934
- [MMH06] MCCOOL, R.; MARTIN, P.J.; HARKIN-JONES, E.: Process modelling for control of product wall thickness in thermoforming. *Plastics, Rubber and Composites*, 8 (2006) 35, pp. 340-347
- [Mos13] MOSER, A.: Nutzung von Prozesswissen beim Thermoformen von Verpackungen. Universität Duisburg-Essen, Ph.D. Thesis, 2013
- [OMS+13] O'CONNOR, C. P. J.; MARTIN, P. J.; SWEENEY, J.; MENARY, G.; CATO-ROSE, P.; SPENCER, P. E.: Simulation of the plug-assisted thermoforming of polypropylene using a large strain thermally coupled constitutive model. *Journal of Materials Processing Technology* 213 (2013), pp. 1588-1600
- [TB99] THRONE, J.; BEINE, J.: Thermoformen Werkstoffe – Verfahren – Anwendungen. München, Wien: Carl Hanser Verlag, 1999

Picture 1: View into the filter inlet (All pictures: © Maag)

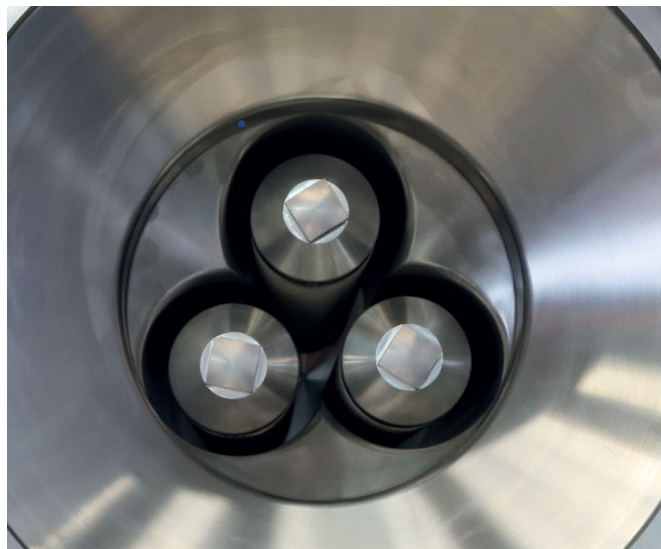

# High-Performance Cartridge Filter System stabilizes XPS Extrusion

*Writer: Christian Lebert, Product Manager at Maag Automatik GmbH in Großostheim, Germany*

*A leading manufacturer of polystyrene extruder foam (XPS) for construction and industrial applications is using a newly developed SFS-3-3000 type static cartridge filter system from Maag. With a filtration fineness of 600 µm or 800 µm, it reliably separates impurities in the form of unmelted particles or agglomerates from the melt and homogenizes them further. As a result, the melt exits the extruder die continuously with a high degree of uniformity*

XPS is a closed-cell, hard insulating material. In its extrusion process, the manufacturer mixes polystyrene pellets with dyes and other additives to create a blend that is melted in a first extruder. After that stage, the melt is mixed with the blowing agent carbon dioxide and then passes through a second extruder, which homogenizes the melt and lowers its temperature. After exiting this through a wide-slotted die, the melt foams into an endless strip which is subsequently calibrated to its final size. The foaming produces a large number of small closed cells. These provide the high mechanical strength of the resulting sheets cut from the webs and makes them insensitive to moisture.

## **Careful filtration assures productivity**

If the melt is not filtered - or insufficiently so - on its way through the production unit, impurities carried along in the melt can settle in the extruder die. The melt flow then divides at this point, so that instead of a continuous web, a two-part web is formed, resulting in rejects. This can be largely ruled out by using a suitable filter system between the cooling extruder and the wide-slotted die - though ensuring that the productivity of the plant is still maintained without restriction when doing so.

After conventional filter systems had proved disadvantageous in practice due to leakages and inadequate service life, in 2017 Maag supplied the manufacturer with a type

SFS-1-1300 cartridge filter system. Since then, it has increased of both filtration quality and service life, as well as delivering very good homogeneity. It was because of those qualities that the customer turned to Maag once again when upgrading a much larger plant.

Christian Lebert, Product Manager for Virgin Polymer Filter Systems at Maag, explains: "This new project demanded a minimum filter unit service life of 8 to 12 months without replacement. At a targeted throughput rate of up to 2000 kg/h, the maximum pressure loss should not exceed 50 bar. Again, leakage-free production was a requirement to prevent material from leaking, expanding in place, and so contaminating the production space and incurring high cleaning costs. Other requirements included that the filter unit should be quickly replaceable and, for cost reasons, should be reusable."

#### Newly developed cartridge filter meets high demands

Maag also proposed the use of a static cartridge filter system to cope with the demanding operating conditions, since the typical design of such a system inherently fulfilled the basic requirements. As the existing SFS-1-1300, featuring only one filter cartridge, was not designed for the high specified throughput, a new design was required.

The result of this upscaling was the SFS-3-3000 cartridge filter system (picture 2), featuring three filter cartridges ( $\varnothing$  75 mm, 415 mm length, flowing through from outside to inside), in a horizontal orientation with a total filter surface area of approximately 3000 mm<sup>2</sup>. Matched to the die gap, which can vary between 1.8 mm and 2 mm, the standard filter fineness is 800  $\mu$ m, though Maag supplied a 600  $\mu$ m exchange kit for test purposes. The entire filter

Picture 2: View into the filter inlet: The stainless steel SFS-3-3000 contains three horizontally arranged filter cartridges (© Maag)

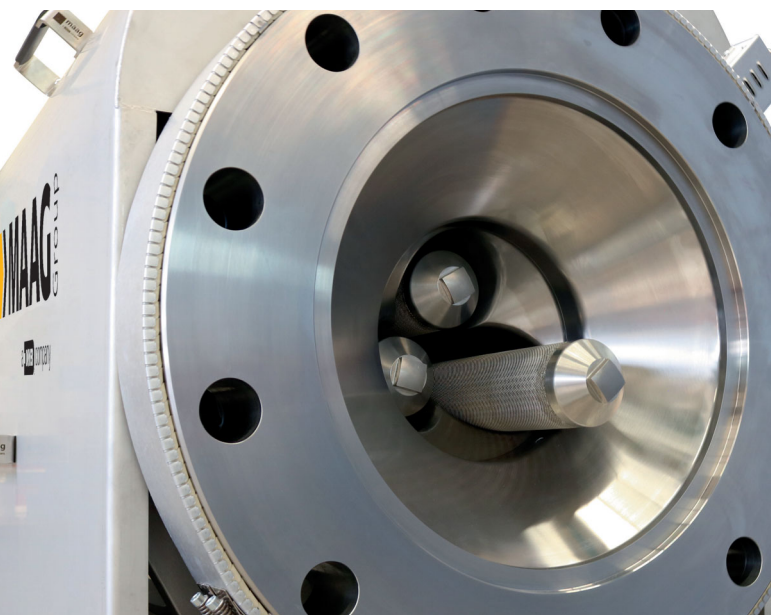

**motan**<sup>®</sup>   
**colortronic**<sup>®</sup>

## Probably the most flexible loader system on the market

 think materials management

Please visit us:  
Hall 9, Stand C64  
16 - 23 October 2019



**METRO G**

Better than ever before.

motan-colortronic gmbh - [info@motan-colortronic.de](mailto:info@motan-colortronic.de)  
[www.motan-colortronic.com](http://www.motan-colortronic.com)

system for this application is made of stainless steel, as some of the melt components, such as flame retardants, are highly corrosive.

On the custom production line, the SFS-3-3000 is located downstream of the second (cooling) extruder. To ensure an optimum fit, Maag replaced the extruder's standard outlet flange with its own inlet flange, providing the best possible interface to the filter system. Maag also adapted the filter cartridges and the free space around them to this special task rheologically in order to achieve an optimum melt flow.

A cooler additionally installed downstream of the filter further lowers the temperature of the melt in the filter under pressure from around 115 °C to around 90 °C, at which point an optimally fine-celled foam develops after the melt has exited the die of the foaming unit. Maag made the customer-specified cooler an integral component of the filter unit and delivered it in the form of an autonomous complete system with heating control and melt pressure monitoring as a side-entry plug-and-play solution (picture 3).

#### Optimum results in production

The SFS-3-3000 filter, optimized for the specific application, started operation at the end of June 2018. Since then, the filter has been able to pass up to 1600 kg of melt per hour at a pressure of 200 bar. The entire filter system is at operating temperature after a heat-up time of around 2 hours with the heater bands (picture 4) recording a heating output of 2 to 3 kWh during operation.

*Picture 3: The integrated unit supplied by Maag consists of the filter SFS-3-3000 and the downstream cooling unit provided by the customer (left side) (© Maag)*

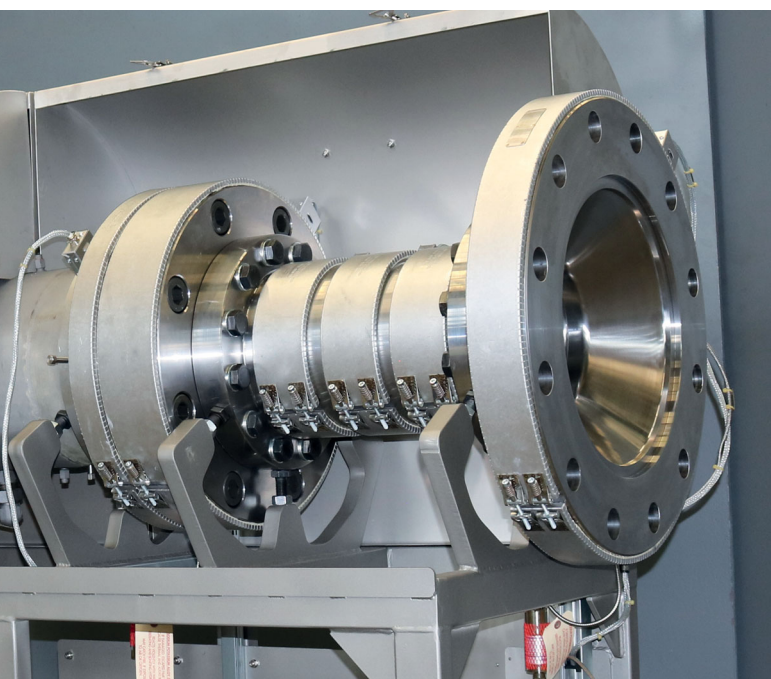

*Picture 4: Three heater bands keep the filter at the specified temperature of 115 °C during operation (© Maag)*

During commissioning, Maag supported the customer in optimizing the process parameters so that good, saleable sheets could be produced after just a few hours. Lebert continues: "As the processors tell us, the SFS-3-3000 also met all the requirements one hundred percent right from the start. Even sheets thicknesses that had been considered critical in the past were run with good results."

#### Long service life for increased cost effectiveness

Like the smaller cartridge filter system, the newly developed SFS-3-3000 also works statically, with no moving parts. So there is no wear during normal operation. When the many months of service life finally come to an end, the cartridges can usually be replaced in the course of scheduled line downtimes, such as during the annual inspection, without the need for additional production stoppages.

Soiled elements can be cleaned and reconditioned after removal. In order to avoid damage and associated cost, the reconditioning should be carried out by specialist contractors or directly by Maag. Even cartridges that have been damaged during handling can be cost-effectively fitted with new gauze for subsequent reuse. To minimize replacement downtimes, Maag offers complete exchange kits comprising the cartridge holder and the cartridges.



K 2019: Hall 9, Booth A04

Maag Pump Systems AG  
Aspstr. 12, 8154 Oberglatt, Switzerland  
[www.maag.com](http://www.maag.com)

# 3D Printing – Benefits for Electroplating Industry

*The use of 3D printers are limitless. What began as a technical gimmick led to new production processes at Betz-Chrom GmbH*



For the electroplating industry, the focus of 3D printers so far has been on the resulting new business field. The metallization of 3D printing components allows their technical function to be expanded. The appropriate surface finishing generates electrical conductivity, protects the components against corrosion and wear or enhances them decoratively. Without the idea of a concrete area of use, the surface coater Betz-Chrom bought a 3D printer relatively early out of an interest in the technology. In a playful way, the employees



gained more and more knowledge about the possibilities of 3D printing. After countless fun prints, from business card cases to small rhinos, the first ideas finally came up on how 3D printing could be used in production. Today, the fixture design for components with complex geometries starts even before the workpiece has arrived at Betz-Chrom. Using technical drawings, CAD software and 3D printing, the component of the customer is “copied” in plastic. The plastic model serves as a working base in fixture construction. When real component arrives, the necessary fixtures and anodes are ready for use and the throughput time is considerably reduced.

After testing the durability of various plastics in a chrome-VI-electrolyte in an internal research project, the fixtures themselves can now also be produced in a 3D printer. The main advantages lie in the very efficient use of materials and the possibility to reprint damaged devices with the stored program.



Knowing that the possibilities of 3D technology are limitless, Betz-Chrom of course continues to “play” with 3D printers. The next idea is sure to come.

Further information on research and development at Betz-Chrom can be found at:



**K 2019:**  
Hall 7 Level I Booth C52

**Betz-Chrom GmbH**  
Am Haag 11, 82166 Gräfelfing, Germany  
[www.betz-chrom.de](http://www.betz-chrom.de)  
[www.betz-chrom.de/en/research-development.html](http://www.betz-chrom.de/en/research-development.html)

# Digital X-ray Measuring Technology in the Production of Hoses and Tubes

*Dr. Hilmar Bolte, Research & Development Head of Analysis, SIKORA AG*

*Since 1993, SIKORA AG has been providing digital X-ray measuring technology for non-contact online measurement of diameters and wall thicknesses in cable production. In 2003, the product portfolio was broadened to the hose and tube industry. Meanwhile, more than 2,000 SIKORA X-ray measuring devices are in operation worldwide. From time to time, however, the potential of the principle is underestimated. Often even reservations against X-ray in general exist, partially influenced by referring to radioactive radiation. Contrary to this, X-rays can be turned off when not in use. Furthermore, products, which are measured by X-ray, are not contaminated by radiation, meaning, they do not radiate further. Even when in operation, the devices are safe from radiation and working in close vicinity does not bear any risk, even long-term. This ensures a safe and smooth handling of this technology*

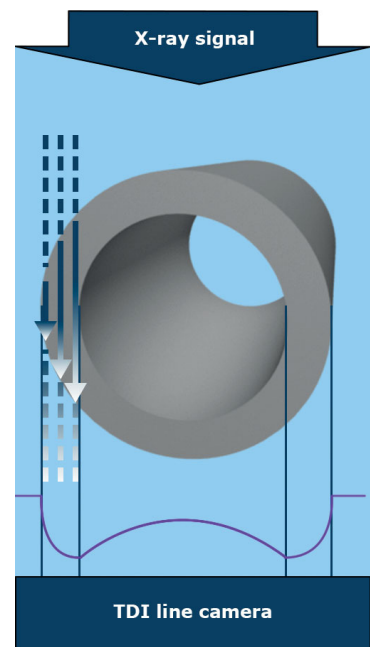

*Picture 1: Design and functional principle of the measurement with X-ray technology*

*Picture 2: X-ray image of a hand (left) and intensity profile of a single layer tube (right) in comparison*

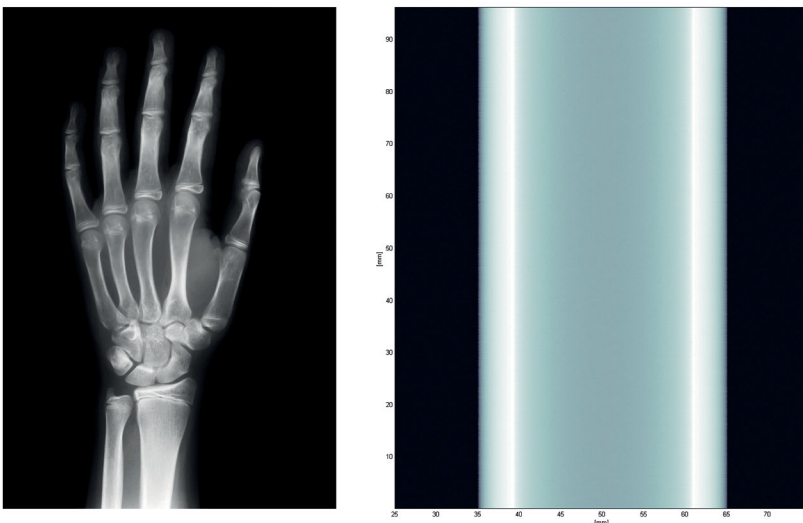

X-ray is known as imaging technology in medical diagnostics. In general, two dimensional images are being generated that allow the doctor to look into the body of the patient. It is displayed in grayscale, resulting from the different absorptions of the X-rays when traveling through the body of the patient. For X-rays, materials have a different transparency. Due to these differences in transparency, it is possible to see where the material begins and where it ends. Tissue, for example, is more non-transparent for X-rays than the bones embedded therein. The same applies when using X-ray in measuring technology. It allows



for a non-destructive look into and through a product. Furthermore, it can be differentiated between miscellaneous materials that vary in their absorption or attenuation of X-rays. The absorption of a material is defined by its composition, its density and hardness of the used X-rays.

**Advantages of X-ray technology**

In particular, when comparing X-ray technology to mere optical methods, it provides several advantages. Due to its low density, gases that arise during the production process, such as smoke or steam, do not interfere with the measurement. The temperature of the object to be measured is also irrelevant for the attenuation and, thus, for the measuring result.

For X-ray measuring technology, the measuring result is stable and con-

*Picture 3: Determination of the minimum wall thickness: The wall thickness under 45 degrees from the outside (red dotted line) is larger than the actual minimum wall thickness (yellow solid line)*

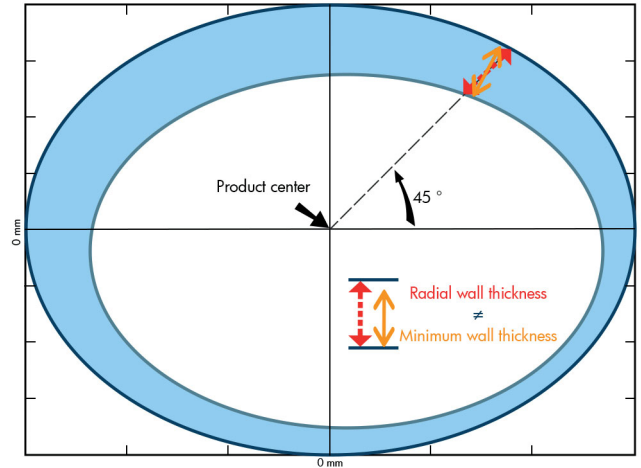

stant after the start-up of the device and the operation point has been reached. There is no warming up phase or a dependence on the product temperature, no coupling media is needed, nor any requirements re-

garding their quality. A correction or recalibration of the measuring values during production is also not required – neither manually, nor by including secondary values such as a gravimetric measurement. This is a

# SEEDS

FOR YOUR PERFORMANCE



K 2019:  
VISIT THE EREMA  
CIRCONOMIC CENTRE

Experience the Circular Economy live in action!  
Outdoor area FG 09.1



+ Pioneering technologies in the fields of post-consumer, bottle and production waste recycling!

EREMA MAIN BOOTH:  
HALL 9, STAND C05

significant advantage in comparison to other measuring methods.

The stability of the measuring value and, therefore, the repeatability are significantly better compared to other methods and do not degenerate over the lifetime because there are no moveable parts in use. There are no moving sensors, which have to be adapted to the product and, thus, changeover times do not occur.

In general, these characteristics suggest the application of X-ray measuring technology for online control of the extrusion of hoses and tubes. Not only the resolution of single layers is possible, but also the presence of electric conductive additives in the materials (for example soot or metallic layers) or of ply do not represent an exclusion criterion.

#### Functional principle

The X-ray measuring devices from SIKORA work with X-ray transmission, meaning that the X-ray source

*Picture 4: The system based on X-ray technology measures precisely the inner and outer diameter, wall thickness, ovality and concentricity of hoses and tubes*



and the X-ray camera are facing each other from the opposite sides of the product (picture 1). Depending on material and thickness of the product, a part of the X-rays is absorbed by the material and the other part is transmitted. Intensity profiles are visible on the camera (picture 2), which show the attenuation of X-rays by the material.

This attenuation is occurring exponentially as it traverses material, thus, the intensity captured by the camera also decreases exponentially. The attenuation coefficient is dependent on the material and the density of the X-rays. Thereby, a "bend" in the intensity curve occurs at X-ray transitions from one material to the next one. By using a multi-layer model based on the underlying physics, the exact position of the transitioning from one material to another can be determined. Hence, with this approach and a geometric model of the product to be measured, the diameter as well as the wall thicknesses can be determined by optimizing the underlying model parameters.

Not only individual information is being processed – as is the case for traditional measuring methods (such as level detection or impulse duration, etc.) – but the camera image as a whole is being analyzed. Hoses or tubes are transilluminated entirely by X-rays due to the absence of a metallic core – contrary to measurements in the cable sector – which would absorb the X-rays.

The key advantage is that, regarding their parameters, all imaging elements in a SIKORA X-ray measuring system are determined precisely and in context – for example, the positions. For this reason, the measuring points stand in relation to each other, which allows for statements about the whole 360 degrees of the measured product. For instance, the minimal wall thickness can be determined precisely and freely over the full circumference (picture 3).

This also allows for conclusions about the positioning of a twisted product at the extruder. The direction to ad-

just the screws at the crosshead is fixed. When the product turns on its way to the measuring point, a rear projection of the wall thicknesses to the crosshead and, therefore, an allocation of the eccentricity to the adjusting screws is required in order to make the appropriate adjustments. This is only possible when a 360 degree model is available. This is also the reason why well-known plant manufacturers for self-centering crossheads refer to X-ray measuring technology from SIKORA.

#### Conclusion

In summary, the application of X-ray measuring devices has many advantages for the production of hoses and tubes that other measuring methods cannot offer. The independency of coupling media, the object temperature and the insensitivity to optical interferences of the measuring environment by steam or smoke is a unique selling point for this technology. Another point is the instant and constant generation of measuring values that are not based on secondary measurements. In addition, a recalibration is not required as there are no movable parts. By using a physical model for the absorption and the knowledge of precise and individual device geometry, statements about the entire circumference of the product can be made. This allows for a determination of the minimal wall thickness over 360 degrees of the circumference. All these points do not only ensure the highest product quality, but also the optimization of product processes and, therefore, a significant increase in efficiency.



K 2019: Hall 10, Booth H21

SIKORA AG  
Bruchweide 2, 28307 Bremen, Germany  
www.sikora.net

# iINNOVATE, iINVENT, iINTERACT

## Novelties made by iNOEX GmbH on K 2019

*Just in time for the K show in Düsseldorf, iNOEX will present its latest product developments in the field of high-precision measuring & control technologies, including the cloud-based production data acquisition and analysis. Moreover, visitors will find product premieres based on x-ray technology and optical diameter measurement on the iNOEX-booth. Visitors can experience first-hand the intelligent networked novelties designed to make the extrusion process more efficient. They can dive into an exciting new dimension of sensor/measuring systems for pipes, tubes, cables, film, EVOH, blown film and foam products*

### **iXRAY – High-precision x-ray systems for wall thickness and diameter measurement in the $\mu\text{m}$ range**

The iXRAY line features a robust and highly precise measuring instrument designed for wall thickness and diameter measurement of single and multiple layer pipes, tubes and rubber products. The core pieces are state-of-the-art x-ray components combined with the latest semiconductor sensor technology. They allow a precise spatial resolution and accuracies in the  $\mu\text{m}$  range. Even with high line speeds the x-ray system supplies – optionally on 2 or 3 axes – precise measuring results. Standard iXRAY systems made by iNOEX are designed for pipe dimensions from 0,6 to 110 mm. During the development of the iXRAY systems, the focus was placed on wall thickness and diameter measurement for multiple layers. This includes particularly aluminium composite pipes, fabric-reinforced pressure tubes, foam products, medical tubes and hoses as well as cables. The main focus is on reproducible dimensional product accuracy in the  $\mu\text{m}$  range and thus the quality assurance aspect. In PVC extrusion, the centering of the extrusion die (e.g. for rubber tubing) or the thermal die head centering are realized by way of an additional interface. Another advantage: the standardized process data interface OPC-UA.

X-ray systems of the iXRAY line have been designed to protect the operator from any risk. Because of their low radiation power, these systems are operated far below permitted legal thresholds. Additional safety devices ensure a completely safe use:

- Hermetically sealed x-ray sources
- Screens to absorb radiation that is not needed
- X-ray radiation individually adapted to specific products
- Safety switches supervise radiation protection shields
- X-ray radiation enabled only in perfect condition

The highest line efficiency combined with raw material savings can be achieved when iNOEX gravimetric systems and proven iNOEX process components are added to the line. This makes iXRAY systems cost-effective complete solutions for the automation of extrusion lines.

The user-friendly iXRAY measuring system was designed for comfortable and intuitive operation based on a completely new development of a widget-based HMI. The 21" operation terminal with a future-oriented and cross-platform operation displays all data, trend graphics and process values and meets the very highest requirements. The line operator only needs to select the pipe, hose or cable recipe and start the measuring process. Due to the responsive design, the configuration can be opened with any web browser or Smart Device.



*iXRAY – High-Performance wall thickness and diameter measurement of multiple layer pipes*

iXRAY systems can be complemented by iXACT diameter measuring systems which are able to carry out up to 16.000 measurements per second per axis. They are frequently used for pipe or tube diameter measurement at the end of the extrusion line and they are implemented in the loop control for shrinkage calibration.

#### **iXACT – Impressive optical diameter measurement**

These systems based on semiconductor sensor technology and high-power LED are able to measure strongly vibrating tubes thanks to their high measuring sequence frequency. The high-power LED make measurement of most transparent materials very simple.

The Plug & Play solution which does not need any calibration also offers a difference function which registers any sudden variations. As such, it is possible to detect irregularities (e.g. knots, necking) on the measured extruded surface.

An additional camera helps to compensate measuring errors due to inclination. This in turn increases the accuracy of the diameter measurement.

The 2 or 3 axes measurement that operates at high speed and with a high precision is available in 3 different versions: for products with a small diameter, for diameters up to 30 mm and for diameters up to 120 mm. The robust design of the system ensures that knocks or temperature changes do not have any effect on measuring results.

In addition to the highlight of the new x-ray technology, iNOEX presents their advancements in radar sensor technology for the plastics materials industry which is very likely to secure the decisive competitive advantages.

*iXACT – Impressive 16.000 measurements per second*

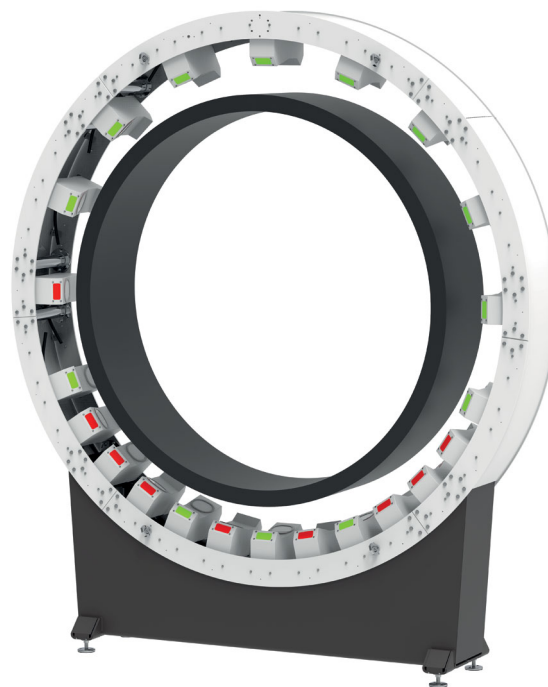

*WARP XXL – High-precision wall thickness and diameter measurement for large pipes up to 3500 mm*

#### **WARP XXL – The system for large pipes – now up to 3500 mm**

WARP XXL is a highly precise pipe measuring system for wall thickness and diameter measurement of 8 to 32 measuring spots on 4 to 16 axes. The system is based on the latest iNOEX radar sensor technology. The innovative radar chip, the specifically designed lens geometry and the high-power electronics are the core parts of this future-oriented technology. The system supplies exact measuring data and offers a very simple operation.

Due to the particularly flexible and modular sensor technology, even pipes that show a strong eccentricity can be measured for the first time. As such, it becomes possible to exactly identify and quantify the occurrence of sagging. Sensors and their measuring spot on the pipe are automatically realigned so that even the smallest variations from set standards become evident. This sagging alarm function implemented early on in the extrusion process offers an enormous cost savings potential.

Further, the number of sensors is flexible which means that the concentration of sensors can be increased in the trouble spots of the process – for example in lower angle positions.

Thus, optimum conditions are created to centre large pipes early on in the process in order to save materials and costs.

WARP XXL is available for diameter ranges from 630 to 3500 mm. It measures (depending on the material) wall thickness sizes between 5 to 250 mm. All iNOEX WARP systems offer further advantages such as an extremely minimized space requirement in extrusion direction, a user-friendliness and the smart maintenance concepts which can be carried

out during the ongoing production process. A complete documentation of the production process in a data bank and the standardized process data interface (OPC-UA) conform to the current state-of-the-art industrial standard.

#### Digitization of your production process

iNOEX offers intelligent solutions to identify optimization potential and to analyze and evaluate product-specific key figures. This creates an added value for your production process. It is not only important to collect a large number of data, but to use it as a reliable guideline for any future production.

iDM 4.0 by iNOEX is a central data logger for process and quality data acquisition. It is executable on almost any existing server hardware thanks to its virtualization and Docker Containers. OPC-UA being the standardized process data interface for the latest measuring, control and automation solutions made by iNOEX, transmits data. Connectivity to legacy systems is granted via iDM Gateway. The integrated iTrend function offers the possibility to visualize production and process data in diagrams and to adapt displays individually.

A further step is the data fusion and analysis through the software „Grafana“. An ideal platform for documentation and supervision of the most relevant key figures, e.g.

the overall line efficiency, and the processing capability of the line. Freely configurable dashboards and reports allow needs-based statistics and analyses and thus the use as hall monitors.

Data transmission via iNOEX Edge Gateway into a cloud-solution of choice, e.g. Microsoft Azure, seamlessly connects multiple locations and thus provides an overview of the current production of all plants and extrusion lines all over the world. Fully in line with Big Data and the analysis options, all data is globally available at any time. Further, process data visualization is possible device-independently on Smart Devices.

In the future, algorithms in conjunction with artificial intelligence will make data evaluation even more simple.

The iNOEX team invites you to its K 2019 booth.

There, interested visitors have the opportunity to experience the extensive iNOEX product portfolio live.



K 2019: Hall 10, Booth E79

iNOEX GmbH  
Maschweg 70, 49324 Melle, Germany  
[www.inoex.de](http://www.inoex.de)



## Sustainable Solutions Worldwide.

battenfeld-cincinnati 

Let's get the act together and meet the challenges of the future – **Process engineering for efficient plastics extrusion of tomorrow.**

#### Our innovative solutions:

- allow the use of recycled material,
- produce in an energy-efficient manner
- and guarantee your lasting investment.

Visit us at the World's No.1  
**Trade Fair for Plastics & Rubber**  
in Düsseldorf from 16.-23. Oct. 19  
in **Hall 16 at Booth B19**



[www.battenfeld-cincinnati.com](http://www.battenfeld-cincinnati.com)

*Water is one of the scarcest resources across the globe and absolutely necessary for all kind of organizations, so its industrial management must be efficient and is a pending issue to be improved*

Source: [www.un.org](http://www.un.org)

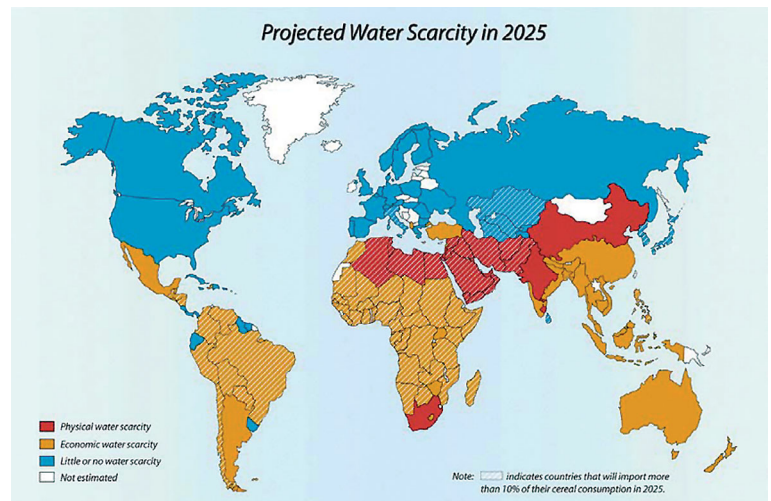

# PVC-O Pipes and Fittings for Industrial Applications

Industries are more and more concerned about the availability of water and more and more industries agree that the availability of water is impacting their business then, this percentage is expected to grow in a few years. The fact that access to water has become difficult over the past few years and that this is likely to increase in the near future, has been acknowledged by some industries and is an issue that worries industries belonging to sectors like chemicals, textiles, manufacturing, etc. Inadequate availability of water is the main problem when running business and poor water quality affects negatively to sectors like pharmaceuticals, food processing or agriculture among others. Apart from this, high costs for obtaining water are behind the business interests of smaller industries and others located in the driest regions of the country.

The development of new infrastructures and regulations has not evolved in accordance with urbanization and the growth of population and as a result of this, the management of wastewater has become a major challenge.

Important improvements to reduce surface water pollution are being made but it also has to face groundwater

exploitation, a source from which lots of cities depend. Bearing all these facts in mind it can be seen that a reform is urgently needed. This reform should consider a reduction in non-revenue water, groundwater exploitation, etc. Most of the water is used for irrigation purposes and, even now, traditional techniques of flooding are followed, something that implies an important waste of water. Modern irrigation techniques such as drip irrigation or sprinkler irrigation have been found much more efficient and are starting to be used; with them productivity increases and the wastage of water is minimum.

After irrigation and supply, the third largest consumer of water is the industrial sector. A proper water management implies a conscious use of it together with its conservation. A series of measures should be taken in order to optimize its use and to avoid its waste. Among these measures it should be taken into account the material to be installed in new projects and infrastructures.

A material that could help to improve the industrial water management and, at the same time, to preserve the environment is the use of PVC-O pipes and fittings, the most eco-friendly material. Although materials tend to lose their mechanical properties when they are subjected to pressure over long periods of time, this process is not as pronounced in Class 500 PVC-O pipes and fittings as in other materials. Bearing this in mind, we can clearly see that pipes and fittings in this material have a useful life of over fifty years.

Molecor manufactures PVC-O pipes and fittings which present important advantages in relation to the optimal use of water. Besides their hydrostatic resistance, previously mentioned, these elements have between 15% and a 40% more hydraulic capacity than systems with pipes made from other materials and with the same external diameter. Their extremely smooth surface contributes,



*OPVC pipes and fittings installation*

at the same time, to significantly reduce head losses and pumping energy while increasing fluid speed. TOM® pipes and ecoFITTOM® fittings, manufactured by Molecor, are the most efficient ones in terms of hydraulic capacity and installation performance. Other characteristic of the pipes and fittings in this material is their incredible resistance to water hammer; they are incredibly resistant to the effects caused by sudden changes in water volume and pressure. This effect depends mainly on the change of direction of the fluid and on the celerity of the pipe. Since PVC-O pipes and fittings have a lower celerity than pipes of other materials, the effect of water hammer on them is much more reduced something that drastically limits the possibilities of breakage when opening and closing networks and when starting pumping operations. Besides this, the incredible impact resistance and ductility of PVC-O pipes and fittings prevent them from breaking when being installed or on site trials. What is more, the molecular orientation process through which they are manufactured prevents the propagation of cracks and scratches and reduces the risk or rapid crack behavior which greatly enhances the useful life of the product. Applied to industrial water management, these pipes and fittings will provide industries with the best solution available in the market to the conveyance of water under

pressure. Their use considerably helps to reduce leakages obtaining a non-degradable system, immune to micro and macro organisms, something that allows the system to have a longer useful life. In the following decades the industrial water and water treatment markets are expected to register a positive growth rate. Manage water judiciously is an increasing need and has resulted in industries taking up water audits regularly in order to fully understand the pattern of the use of water in their operations and to look for water saving measures. In most cases water conservation measures have been implemented by the companies and the results obtained are being monitored. Companies extend the feel of water conservation to all employees and big efforts are being made to implement saving measures. The water savings are being calculated and different training and awareness programs are being implemented. Sustainable models of water conservation are being explored but there is still lot of work to do in order to implement measures at large scale.

► Molecor, Spain  
<http://molecor.com/en/>



## Quality oriented towards a sustainable tomorrow

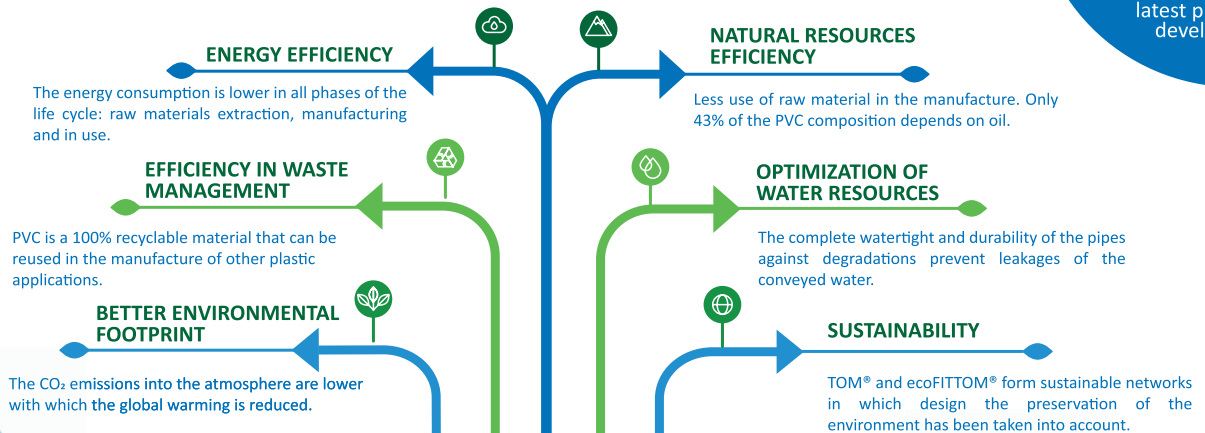

Visit us at

**Hall 16 Stand B17**  
and discover our latest projects and developments

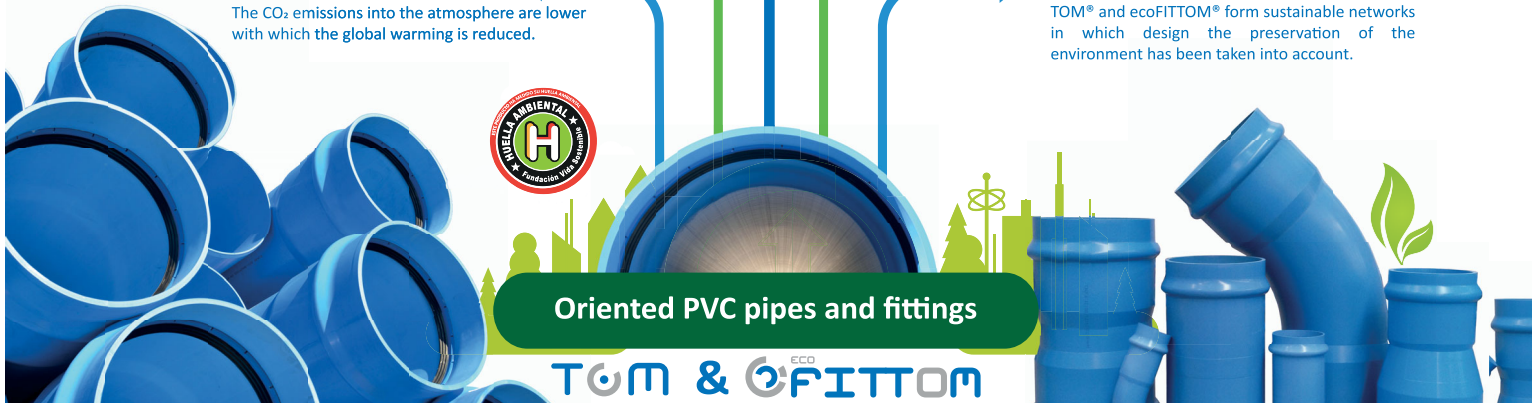

Oriented PVC pipes and fittings



# Highlights in the Film Blowing Technology from Russia

*Company ALEKO Machinery – the Russian manufacturer of equipment for polymers processing – will take part for the third time in the biggest industry show K 2019 in Dusseldorf, Germany. In the booth the company will present the newest inventions created in the line with the recent trends in the plastic industry*

## High Speed film blowing line working with Biodegradable raw material

The production of packaging materials is following the ecology trends. Changes influence the whole market and now many countries new restrictions of using of polyethylene shopping bags or even a complete ban of PE bags are imposing. This fact is pushing the industry to react and to adapt the packaging materials production by using new biodegradable raw materials

ALEKO meeting the market demand have offered a decision by creating a blown film line capable to process modern biodegradable polymers on the base of polylactic acid (PLA) and polymerized corn and potato starch.

## Gravimetric dosing system



The design of this machine lead not to just an adaptation of existing technical solutions of ALEKO company in PE film blowing extrusion, but to a complex modernization of the most parts of the machine. Absolutely new structure screw and die have been designed and built.

In K 2019 show booth an extrusion line built specially for these tasks will be presented. Visitors could see the line working in four types of Biodegradable materials including Ecovio (BASF), BIO COMP (Microtec), Gemabio (Gema). And they can personally value samples of ready film. The machine is capable to produce film made from different Biodegradable materials with the thickness starting from 8 to 10 micron.

## High Speed HDPE film blowing line

The design of Extrusion lines working with traditional HDPE also does not stand still and keep on evolving. In addition to the quality of produced film more and more attention is devoted to production capacity. It means that the task to produce more volume of ready product in a fixed time becoming to be critical. Existing models of ALEKO extruders are popular in the market thanks in large part to their high production capacity even in standard specification.

But there's no limit to perfection. In the exhibition visitors will be able to see one more invention of the company – High Speed HDPE film blowing line specially for thin films. The line speed up to 200 m/min, and the film thickness from 5 micrometers. In the booth visitors could see the extrusion line in work and to see results and parameters online.

## Automatic Film Thickness Control System

ALEKO company is presenting in K 2019 show exhibition the first designed and created in Russia Film Thickness Control



High Speed HDPE blown film line ALEKO TURBO

System. Device is developed for continuous measurement and on-line correction of sleeve type film thickness during extrusion in a real time.

Thickness control is made synchronously by temperature correction and by correction of airflow rate. Complex approach helps to reduce film thickness tolerance to 70%.

Circular system of continuous measurement of film thickness made on the base of Kündig (Switzerland) capacitive sensor is fixing thickness deflection from set figure. Received by the sensor data is transmitted to controller and special software calculate appropriate algorithm of system reaction and needed segment of the film get treatment. Air flow actuators are regularly distributed

## Automatic Film Thickness Control System





over the air ring perimeter. The number of adjustment segments in Air ring is 72 pcs in each from two layers. 72 actuators in one layer are in charge of airflow rate. 72 actuators in the other layer are in charge of air temperature. Total number of actuators sum up to 144 pcs (for die dia. 300 to 350 mm) which exceed any of existing thickness control system in the market.

It should be stressed that for the present time Automatic PE Film Thickness Control System from ALEKO is the most economical in the market if compare prices. The Device could be used both in a new extrusion lines and in existing ones to improve film parameters and to save raw material. Visitors can check the price in the company booth in the exhibition.

#### Raw Material Dosing Systems with Extrusion Control

ALEKO-Machinery is the only one manufacturer of Volumetric and Gravimetric dosing systems with extrusion control

function and with high accuracy (up to 0,04%) in the territory of former USSR states. Both models of dosing systems became popular in the markets of Russia, Central Asia and East Europe.

By keeping on developing the Company has widened the model range by creating a raw material supply system with extrusion control. The designed system helps you simultaneously to adjust raw material feeding, screw rotation speed and take up rollers speed. This is helping to set appropriate weight of one meter of film and to keep it maintaining during all production process. Described system with the minimum expenses will help to reach high automatization and stability of production in the cases if the materials blending is not needed. In the company booth in Dusseldorf exhibition there will be presented the most popular models.

#### Additives

In addition the visitors of K 2019 Show will be pleased by renewed and extend-

ed assortment of color masterbatches, CaCO<sub>3</sub> fillers and additive masterbatches under the company trade mark A-Len presented in the ALEKO booth. The company's own plastic processing factory plus many years of experience are helping to form the masterbatches model line with a high quality which can be guaranteed by the company. This is the reason why A-Len masterbatches are known and are demanded in the USA, EU and former USSR states markets. Visitors can value all above described products from ALEKO company in K 2019 Show. They will be pleasantly surprised by not high for the market prices for equipment and polymer additives and they could receive answers to all their questions.



Aleko Machinery

[www.polimerexpert.ru](http://www.polimerexpert.ru)

K 2019: Hall 16, Booth F42

# ALEKO



2019 16-23 October  
Düsseldorf  
Germany

## BOOTH 16F42



### YOU WILL SEE:

- ✓ High Speed blown film line working with Biodegradable raw material ALEKO BIO (film thickness from 8 mcm)
- ✓ High Speed HDPE blown film line ALEKO TURBO (HDPE, 200 m/min, film thickness from 5 mcm)
- ✓ Automatic film thickness control system
- ✓ Gravimetric and volumetric dosing systems, extrusion control system
- ✓ Color and additive masterbatches

Rostov-on-Don, Sokolova avenue, 29, Russia

+7 (863) 261 88 88

[info@polimerexpert.ru](mailto:info@polimerexpert.ru)

[www.polimerexpert.ru](http://www.polimerexpert.ru)

# Recyclers are investing strongly

Interview with Manfred Hackl, CEO Erema GmbH

*More and more manufacturers of consumer goods promise to launch only recyclable products in the near term. Are there already sufficient capacities to achieve this?*

**Manfred Hackl:** In recent years, substantial capacities have been developed, and many more will follow. Of course, this is driven by demand. The more regranulate is in demand the more capacity will be created. At present, the market is on the move.

*Do you also observe this trend at Erema as supplier of recycling machines?*

**Hackl:** You only need to look at the past three years to see where the trend is heading. In recent years, our turnover has continuously risen, so that in the past business year we have increased to 180 million euros. Recyclers, our customers, are currently investing strongly.

*Does the recycling market need different machines?*

**Hackl:** Recent years have seen many technological developments, for example in the field of process stability, filtration or odour minimisation, and many new products have hit the market, allowing recyclers to manufacture higher quality regranulate. This and also further development in the field of processes preceding extrusion can achieve results today that were unimaginable three years ago. This trend will continue. Mechanical recycling will further develop. For regranulate is no longer utilised to make only park benches but also many high-value products.

*At present, fibre-reinforced plastics can hardly be recycled. In view of the high pace of innovation, will there be recycling solutions also in this field?*

**Hackl:** Basically, it is possible that in the long run solution approaches will be available. But it would not be right to concentrate our efforts on recycling of CFK, for instance. Wind turbines and other parts made from this material will not cause any problems for many years to come. We should rather focus on issues that are now required. Naturally in parallel, you can also proceed with developments making CFK recyclable. But currently packaging waste disposed in the environment is the greater challenge. It is vital to close the circuits more quickly and in a better way.

*Many plastics manufacturers are researching in the direction of chemical recycling. Does that mean business losses for mechanical recycling in future?*

**Hackl:** Chemical recycling is still a vision, and in the long term at that. But even when it works out, it will always be a supplement to mechanical recycling as the techniques in this field have already been perfected and are more economical. Very



high-grade granulate can be produced for many applications by mechanical recycling, and there are constant optimisations and new developments as will be shown at the K 2019. It also has the smallest CO<sub>2</sub> footprint. Chemical recycling might be applied in special cases but not for the larger part of the material. I do not really see it as competition since there is enough material for everyone.

*Can an efficient circular economy be exported from Europe?*

**Hackl:** I am convinced that it can act as role model for other regions in the world. It is possible that all parties involved here in Europe – i.e. the industry, the machine manufacturers, the waste disposers – show how to set up collection systems, how to implement the individual steps and how all parties can work together. Then a business model could indeed be created fit to sell this technology by way of service, consultancy or equipment. In China, the notion of circular economy is already taking root. In Shanghai, a collection system was introduced and has been effective since the 1st July. It was implemented within a few months. Very quickly again, as we would expect from China. This way of thinking is meanwhile widespread in the minds of Chinese decision makers. The country has been recycling for a long time, until recently imported plastic waste, by the way. I think that export opportunities will increase if we push and spread the idea of circular economy.

*Will the bad image of plastics improve when we have circular economy in Europe and when we can show the public that it functions?*

**Hackl:** Definitely. It is mainly a matter of proving and communicating it. For one thing is sure, in future we will need plastics even more urgently than today in order to maintain our standard of living and our way of life, also in the face of a still rapidly growing world population. For this reason, we must close the circuit for plastics the way we did with paper, metal and glass.

*Thank you for this interview.*



K 2019: Hall 9, Booth C05, 09.1, C28

EREMA Group GmbH  
Unterfeldstr. 3, 4052 Ansfelden, Austria  
[www.erema-group.com](http://www.erema-group.com)

# “Circular economy will give us a competitive edge”

Interview with Thomas Herrmann, CEO at Herrmann Ultraschalltechnik GmbH & Co. KG

*All players along the plastics value-added chain are joining forces in Europe to initiate a functioning circular economy. No other country has such an initiative. Will Europe soon be at a competitive disadvantage?*

**Thomas Herrmann:** A functioning cycle for plastics is closely linked to striving for sustainability, reduced use of resources and material recycling. It is more likely that the knowledge of these processes and the development of the required technologies will bring Europe a competitive edge, as other regions will also have to deal with this issue in the future so that the European industry and research landscape will be able to occupy new export fields, in terms of machines and systems as well as process technology.

*What can Herrmann Ultraschall do as part of the value-added chain? Who or what can you influence?*

**Herrmann:** The machines and components we develop for blending plastics avoid additives such as glue or screws and, ipso facto, contribute to avoiding unnecessary use of material or material compounds. For this purpose, ultra-sound welding is very energy-efficient compared to other joining technologies, that means the welding process uses very little energy. Consequently, this saves resources. Ultra-sound joining technology also works with components made of recycled granulates and various bioplastics.

*Plastics packaging, perceived by the public as floating layers of plastics in the oceans, have become the target of criticism. How do you deal with this criticism?*

**Herrmann:** Of course, the pollution of oceans with plastic waste is tragic and unacceptable, but it results from incorrect handling of garbage and not from the

plastics product itself. Plastics packaging plays an important role in ensuring that an ever-increasing world population is fed, and they reduce the use of natural resources. Approximately, one third of all produced foods deteriorate on the way from production to processing; that means before they can even be packaged. The right plastics packaging whose weight and CO<sub>2</sub> footprint makes up just a fraction of the food to be protected helps avoid this wastage. But there is still potential for improvement. The amount of unnecessary one-way packaging must be reduced, and some secondary packaging must be scrutinised.

*Could bio-plastics become the commodity of the future?*

**Herrmann:** We think that plastics from renewable raw materials will gain importance in future. Apart from process engineering and hygienic standards they must also meet ethical requirements. We must consider whether they aren't produced in fields which are then no longer available for the production of food. However, these materials will not solve the problem of pollution as they are not fully biodegradable under natural conditions.

*Which commercial benefits does circular economy offer?*

**Herrmann:** The predictable end of fossil fuel availability will lead to a clear rise in mining costs. The climate-damaging impact is already noticeable and holds great economic risks. For these reasons, circular economy can only have commercial benefits as in particular mining and production costs but also the costs of repairing damage and renaturation will decrease. It is a win-win situation for all parties involved, the economy, the environment and all mankind. Currently, processed granulate is more expensive than virgin material. From an economic point of view, the motivation to use this is low. If, however, our technology offers vital advantages



CEO Thomas Herrmann and Head of Development Marco Lanza discuss the digital requirements for the Circular Economy

compared to other joining methods, the situation will get interesting. EU regulation would definitely help encourage and increase the use of bio- or recycled plastics.

*What should politicians do to support circular economy?*

**Herrmann:** The role of politics is to provide the framework conditions, bearing in mind global competition. We need regulation because experience shows that market response is best achieved by legal provisions. We should however beware of over-regulation. The minimum requirement is uniform European standards in order to ensure that we, in a European living and economic space, pave the way for circular economy into a successful future.

*To what extent does digitalisation support the implementation of circular economy?*

**Herrmann:** Digitalisation is a prerequisite. Plastics that circulate in a cycle will not have constant or uniform properties. The better the digital signature of the raw material is and the more data from the individual process steps can be used, the better the recycling steps will work. In other words, all information along the value-added chain must be consistently available to enable the appropriate additional processing steps for closing the cycle.

*Thank you for this interview.*



K 2019: Hall 11 / E26

**Herrmann Ultraschall**  
Descostr. 3-9, 76307 Karlsbad, Germany  
[www.herrmannultraschall.com](http://www.herrmannultraschall.com)



(Photos: Messe Düsseldorf, Constanze Tillmann)

## Circular Economy: Hot Topic at K 2019

Plastic products have become an integral part of almost every area of life. For good reason. Plastic packaging extends the shelf life of food, plastic parts in cars reduces their weight and CO<sub>2</sub> emissions. In medicine, plastics ensure maximum hygiene standards and make medical products safe. Despite its many advantages, this important raw material has come into disrepute for some time now – because of the plastic waste that pollutes entire regions and floats in huge carpets on the world's oceans. But this problem can be solved. As the concept of "circular economy" plays a central role in this, it has become a hot topic at K 2019 which will be hosted from 16 to 23 October 2019 in Düsseldorf/Germany.

The idea at the root of the circular economy concept is quite simple: once used, valuable raw material can be

processed at the end of its service life and be reused to create a new product – in an infinite loop. While some materials have limitations that do not allow this, a vast array of polymer materials are perfectly suitable for this approach. A circular economy dramatically reduces waste and also protects the resource of crude oil, because whenever new products are made from recycled plastic, there is no need to use raw, i.e. previously unused, materials.

About seventy years ago, plastics became a mass product. The University of California estimates that about 8.3 billion tons of plastics have been produced since then. Particularly in the wake of the strong population growth in many parts of the world, plastics production rates have shot up in recent times. The survey shows that the figures rose sharply: from 2 million tonnes of plastics produced in 1950 to 348 million tonnes in 2017. Accordingly, we have witnessed a substantial rise of plastic waste and we are faced with an urgent question: how to manage plastic waste sensibly? Two pressing problems are at the root of this complex challenge: littering and the unrestricted use of resources, which not only damages the environment but also slows economic growth.

Many countries have now realized that they need to change their approach if they want to harness the undeniable benefits of plastic products for years to come. In its plastics waste management strategy presented in 2018, the EU has shifted its focus to the recycling sector. In China's current five-year plan, circular economy is postulated as a goal. Countries such as India and Indonesia have declared war on plastic waste pollution. There are





that it is ready for reuse in the production of plastic parts. Many of these technologies already exist. However, the quality of the recycled material often poses a problem. All experts agree on one thing: sustainable, global change and the successful and permanent implementation of a circular economy requires support and cooperation along the entire value chain, from the material manufacturer to the end consumer. Sustainable behaviour begins at home and at school.

At K 2019 in Düsseldorf, the subject of recycling management will not only cover a large amount of space at the exhibitors' stands, but will also feature prominently in the supporting programme. For example, the circular economy will be the dominant topic at the "Plastics Shape the Future" special presentation hosted by PlasticsEurope, and the VDMA will organize the "VDMA Circular Economy Forum" for K 2019.

At the entrance gates to K 2019, the "Touch Points Circular Economy" will attract the trade visitors' attention to this topic and point out relevant exhibits in the various halls.

also approaches to a cycle in Africa, for example in Nigeria. Because criticism of plastics has also been growing among consumers in many places, a whole series of international brand manufacturers have already committed to the cause and adopted their own recycling strategies. Recycling is another core component of any circular economy. We need technologies that allow cleaning, segregation, shredding and pelletising of used plastics to ensure

www.k-online.com



We increase your profit margin.



Efficient solutions for higher quality, maximum value and optimized ROI

- 1 MAS Extruder
- 2 CDF Melt Filter
- 3 TA Cascade

€ up to +4 Mio € higher sales



A+++ more than -100.000 € lower energy costs possible



+200% up to bigger screen surface



+15% up to higher density



- Recycling
- Upcycling (Re-Compound)
- Compounding
- PET-Extrusion
- Direct Extrusion
- Dry Cleaning

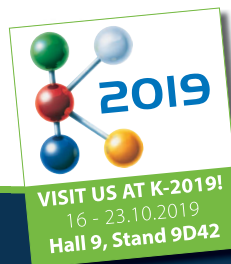

MAS Maschinen- und Anlagenbau Schulz GmbH  
Hobelweg 1, 4055 Pucking, Austria  
T: +43 7229 78 999  
F: +43 7229 78 999-10  
E: info@mas-austria.com



Depending on the required throughput, the modular stationary SOMOS RDF (Resin Dryer Flexible) resin drying system can be made up of a number of independently operating drying modules, this system comprising four components (Photos: ProTec Polymer Processing)



## Two premieres at K 2019

K 2019 is where ProTec Polymer Processing will be presenting the SOMOS RDF modular resin drying system for flexible stationary use without a central dry air generator. The system consists of autonomously operating units with their own Industry 4.0-capable controllers. Depending on requirements and desired throughput, the individual modules can be combined into a variable overall system with central visualization and control.

Another premiere at K 2019 is a high-speed retrofit for ProTec's LFT pultrusion lines. This retrofit can straightforwardly boost the production speed of existing manufacturing lines for high quality long fiber reinforced thermoplastic pellets from 30 m/min to 50 m/min, so considerably increasing output of high quality pellets and cutting production costs.

*A high-speed retrofit is the straightforward way to boost production speed on existing ProTec LFT pultrusion lines for manufacturing high quality long fiber reinforced thermoplastic pellets and to distinctly increase pellet production volumes*



To illustrate the many and varied possibilities offered by an LFT pultrusion line, ProTec will also be showing various products produced on the line.

ProTec will also be giving live demonstrations of physical foaming using the "SOMOS Perfoamer" manufacturing solution, which was presented in 2018, and offering an overview of its comprehensive range of components and solutions for efficient materials handling.

### **Modules with their own dry air supply can be combined to create a complete RDF system:**

Depending on the required throughput, the modular stationary RDF (Resin Dryer Flexible) drying system can be made up of a number of independently operating drying modules. Components are available with capacities of between 50 and 400 liters, each one being individually controllable by its own controller. Alternatively, when interconnected, they can be controlled using a common operator control unit. As standard, they offer drying temperatures of 60°C to 140°C and high-temperature variants for up to 180°C are also available. Each module has an integrated air generator, so ruling out complete failure, as may occur with a centrally supplied drying system. Installation requires little space and effort as the modules are compact and, in comparison with a central drying system, do not require extensive supply and return air piping. The RDF modular drying system also saves energy because only the components which are actually required are operated. If requirements change, modules can be simply added or removed.

Like the tried and trusted mobile SOMOS RDM series resin dryers, the RDF modules also have an Industry 4.0-capable PLC controller capable of storing up to 200 formulations. They have their own dry air generators and also provide



*The SOMOS RDM series mobile resin dryers, the photo showing the SOMOS RDM-70/200, can be used as a variable auxiliary unit for processing machinery*

various smart energy-saving systems: drying air volume is automatically adapted to actual throughput while regeneration cycles are controlled on the basis of the actual water content of the pellets.

**Boosting throughput with high-speed retrofit for LFT pultrusion lines:**

A simple high-speed retrofit can noticeably boost output volumes on an LFT pultrusion line for high quality long fiber reinforced thermoplastic pellets. The production speed of existing systems can be distinctly boosted from 30 m/min to 50 m/min by various modifications and additions.

For instance, ProTec has incorporated an additional pre-heater and optimized die geometry, so accelerating fiber temperature adjustment and ensuring high quality fiber impregnation even at high production rates. Cooling capacity was also increased with an additional water bath. ProTec has also made adaptations to the pelletizer. Carefully arranged rotary knives cut the pellets at high speed to the ideal processing length of 6-12 mm.

**Handling materials efficiently with Batchmix batch dosing units and RDM resin dryers:**

As a one-stop shop materials handling supplier, ProTec will be showing the Batchmix 50 and Batchmix 350 batch dosing units from its SOMOS series of the same name. There will also be live demonstrations of the SOMOS RDM-40 mobile resin dryer, whose primary application is as a variable auxiliary unit for processing machines.

**Flexible Batchmix batch dosing units for as many as twelve components:**

The versatile modular SOMOS Batchmix series of gravimetric batch dosing units is available in fourteen sizes for throughputs ranging from 5 to 3,000 kg/h. The smallest unit with its throughput of up to 50 kg/h can dose four components while, depending on size, further models can process up to twelve flowable materials at once. Specially developed high precision dosing devices mean these models are capable of quickly, accurately and reproducibly manufacturing a variety of changing pellet and regrind blends.

The SOMOS Batchmix is operated using an intuitive, high performance touchscreen controller which, thanks to its integrated communication interfaces, is simple to integrate into higher-level control systems. Retrofittable option packages further extend functionality. For example, extruders and film haul-off controls can be integrated into the controller.

**SOMOS RDM mobile dryers:**

SOMOS RDM series mobile dryers, capable of reliably and energy-efficiently drying any hygroscopic materials, simplify frequent material changes on processing machinery. They are also capable of automatically supplying pellets to machines by dry air conveying, so enabling convenient remote process monitoring. The SOMOS RDM series consists of five models with bin volumes of between 50 and 400 liters.

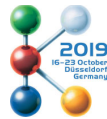

K 2019: Hall 9, Booth D60

ProTec Polymer Processing GmbH  
www.sp-protect.com

**From the Simple to the Sublime**

**Series 800 crosshead for two to six layers**

The latest generation of the **Series 800 crosshead** is designed to run two to six layer extrusions for high quality, high accuracy 1/8" to 6" OD tubing for medical, automotive, appliance and industrial applications.

Ideal for fluoropolymer multi-lumen, multi-layer tubing for fuel lines or thin layer combinations of polymers and adhesives to 0.02mm or less.

Features patented **Guill Feather Touch®** concentricity adjustment to eliminate leaking.

Please visit [www.guill.com](http://www.guill.com)

10 Pike Street  
West Warwick, RI 02893  
USA  
sales@guill.com Attention: Bill Conley



# New Technological Developments for Sustainable Packaging Solutions

ILLIG Maschinenbau will be presenting multiple technological novelties at the K in Düsseldorf. At this year's stand the focus will be on sustainable packaging solutions according to the theme of circular thinking with aspects such as Designed for Recycling and Eco Design. The responsible management of plastics and striving towards a closed circular economy are very important to ILLIG as a traditional family business and pioneer in the thermoforming industry. ILLIG is constantly pushing forward with new developments within the context of their 360° tailor-made packaging development, Pactivity®.

New sustainable IML-T® Cardboard application: ILLIG will be presenting a number of new developments in both their tool and machine business segments. Among them is the new, designed-for-recycling plastic-cardboard combination pack IML-T® Cardboard that can be decorated on both sides and whose plastic inlay easily separates from the outer cardboard layer. A team of ILLIG Pactivity® experts from interdisciplinary fields came up with this innovative packaging solution to meet the demands of being designed for recycling and having an eco design. The team of ILLIG engineers preserved what was good, fine-tuned the existing technology and added new improvements. This innovative pack-

*Circular Thinking! at ILLIG. The new IML-T® Cardboard application reduces plastic consumption by 60% and is easy to sort for recycling (Source of pictures: ILLIG)*



aging solution can be produced on all ILLIG IML-T® machine lines and offers new possibilities of decorating in thermoforming.

New! Brilliantly decorated lids with IML-T®: With yet another first-to-market IML-T® innovation that was also developed with recycling in mind, ILLIG will be demonstrating cups made of rPET with easily separable paper labels. To go along with this innovation, ILLIG has also set a new milestone in thermoforming technology. For the first time, ILLIG will be showcasing its new thermoforming system IC-RDKL 80 at the K 2019. The IML-T® system produces brilliantly decorated lids made from rPET to complement decorated cups that are also made of rPET. This makes ILLIG the world's only one-source supplier of multiple IML-T® thermoforming systems in response to the increasing market demand for IML-T® applications.

4th generation ILLIG thermoformer: Another innovation being showcased at the K is the first 4th-generation thermoformer. The new production system IC-RDM 76K features unprecedented performance with a completely new drive system and significantly more closing force. The machine will be producing drinking cups made of recycled PET.

Digital transformation in thermoforming: ILLIG will be showcasing developments in digitization in thermoforming at the K 2019 that aim to significantly increase the overall availability and thus also the productivity of ILLIG systems. ILLIG Connectivity securely connects the customer's thermoforming production systems into his network, enabling them to be better integrated into his value-added chain.

Connectivity optimizes job and process control, and facilitates data exchange, logging and archiving. Further steps in Connectivity in terms of Industry 4.0 will also be presented at the K 2019.

The new ILLIG thermoforming system IC-RDKL 80 for the production of decorated IML-T® lids



K 2019: Hall 3, Booth A52

ILLIG Maschinenbau GmbH & Co. KG  
www.illig-group.com



# Faster, Quicker, and Less Expensive: Flat Dies Reworked with Cutting-Edge Technology



Part of the Reifenhäuser Extrusion Systems portfolio:  
Rework of existing flat dies

Modernizing and optimizing an existing cast film line can work without extensive capital investments. And a new business unit set up by the Reifenhäuser Group is proving exactly this: Reifenhäuser Extrusion Systems (RES) specializes in components for demanding applications and covers the following product areas: screws and barrels, extruders, flat dies, and extrusion tools. In setting up RES, the Troisdorf-based family company has brought all the expertise of the Reiloy, Extruders, Enka Tecnica and Extrusion Dies business units under a single roof.

"Rework" is the name of the solution that enables customers to optimize their existing equipment. Customers can increase production output and react flexibly to current trends in the market without having to buy a new cast film die. "Quicker and cheaper than a new die, better than the old one: The most expensive solution isn't always the most efficient," explained Philip Neumann, Sales Director at Reifenhäuser Extrusion Systems. "Our experienced rework specialists are on hand to advise customers. Where it's not clear cut, they also advise against unnecessary new purchases."

Previously, the Troisdorf-based firm had only reworked dies that were manufactured in-house. Now, the "Extrusioners" also offer reconditioning services for flat dies

made by other manufacturers. "Our customers benefit not only from our first-class components, but also from our extensive expertise which means that we optimize existing dies," added Philip Neumann

The company provides value with its worldwide sales and service network, extensive engineering know-how, and expertise in technical processes. All this from the point of view of economic efficiency and sustainability: The extrusion components are tailored to customers' needs and are offered at attractive prices, with delivery times in line with the market.



K 2019: Hall 1, Booth E40 (flat dies) and  
Hall 11, Booth B22 (screws and barrels, extruders)

Reifenhäuser Extrusion Systems (RES)  
[www.reifenhauer.com](http://www.reifenhauer.com)

FOCUS ON THE FUTURE





Expect something new at the K 2019!



Please visit us at:  
Hall 14, Booth C03



- New, functional machine design
- High-output and Energy-efficient Extrusion Package
- Magnetic quick mould change system
- New generation Bekum Controls 8.0

Bekum Maschinenfabriken GmbH  
Phone: +49 (0)30 7490-0 • [sales@bekum.de](mailto:sales@bekum.de) • [www.bekum.com](http://www.bekum.com)



*BUSS's new COMPEO 88 and 110 models will be introduced at K2019, adding higher throughput machines to the COMPEO series (© BUSS AG)*

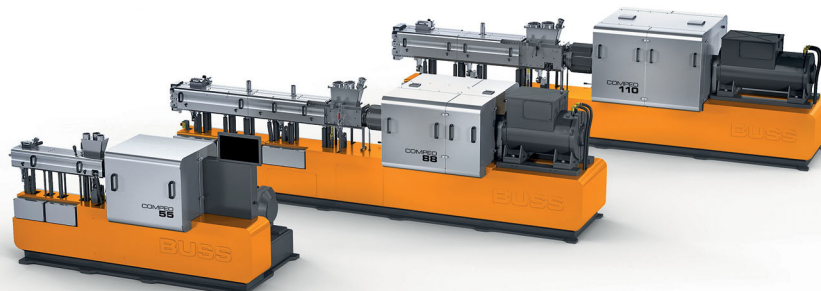

# New Models Extend Applications for COMPEO Compounders

BUSS's new COMPEO 88 and COMPEO 110 kneaders for plastics and elastomers are to be introduced at K2019 in Düsseldorf, adding two higher throughput models to the COMPEO range of compounding systems. They join the smaller COMPEO 55 which was launched to the market around one year ago. All three models are available with process lengths from 13 L/D to 25 L/D, the model size indicating the screw diameter in mm. Typical throughputs for processing thermoplastics are 150 to 300 kg/h (COMPEO 55), 600 to 1200 kg/h (COMPEO 88) and 1200 to 2400 kg/h (COMPEO 110). This gives operators the opportunity to use a system size optimally adapted to their requirements and thus work with maximum efficiency. BUSS is presenting their current largest system, the new COMPEO 110, with a processing length of 18 L/D, including a downstream side feeder alongside their new conical twin screw discharge unit. In this configuration the system is suitable, among other things, for compounding filled

and reinforced thermoplastics, including natural fiber-reinforced and bio-based plastics as well as HFFR cable compounds.

With a process length of 25 L/D, the new COMPEO 88 is optimized for compounding black or colored masterbatches and it can if required be fitted with one or two additional side feeders. The first user of such a COMPEO 88 will be a European masterbatch manufacturer who is due to take delivery of the new system from BUSS before K2019.

Specific advantages of COMPEO compounders include high-intensity mixing, high filler contents and precise temperature control. Assembled from standardized modules, they permit cost-effective configuration of specifically optimized compounding lines for a wide range of processing tasks and temperatures. These range from thermally sensitive thermosets to demanding engineering polymers with processing temperatures of up to 400°C (750°F). The great flexibility of the COMPEO series is its ability to combine

conventional three- or four-flight kneading elements with new elements comprising two or six flights and to put them to use in any desired position within the process section. Combined with an increase in specific torque, this permits longer mixing zones without any additional increase in energy input. The control system with its OPC UA interface makes COMPEO completely Industry 4.0 compatible.

Visitors to the booth will also be able to discover more about COMPEO technology for various applications in the multimedia BUSS CAMPUS. This new platform will be available online after the fair and will allow registered users to download technical videos.



**K 2019: Hall 16, Booth A59**

**BUSS AG**  
[www.BUSScorp.com](http://www.BUSScorp.com)

# Automation and Auxiliary Equipment for the Plastic Industry

Moretto presents itself as a "partner of solutions", capable of listening to customer needs and responding effectively with dedicated and customized products.

Starting from the customer and his specific needs, Moretto provides K 2019 visitors with an overview of unique solutions and systems, consisting of energy-saving technologies and 4.0 control and management devices, essential tools for an efficient and sustainable production. A necessary approach to "win the challenge" in a market composed of customers with complex and diversified performance needs based on the sector of application and the production process.

As in a large stage, Moretto will exhibit the most innovative systems and products for injection moulding, blow moulding and extrusion. There are two exhibition areas in Hall 11, one specifically dedicated to the extrusion sector, with Contrex brand products, the group brand specialized in the supply of automation and control systems for blown film extrusion.

Moretto presents the X COMB series of dehumidifiers, extended in the range to cover higher production needs. These mini dryers are a real combination of patented Moretto technologies: fully electric (they do not use compressed air), they are equipped with powerful turbo-compressors, zeolite technology, the Dew Point equalizer and the exclusive OTX hopper.

The ON series, with compact and robust models, is suitable for installation directly on the mouth of the processing machine, guaranteeing constant quality during the production process.

The SIDE series includes larger models up to 24 kg/h, with the installation next to the machine, to satisfy higher productions or in battery on trolley for maximum production flexibility.

As for all Moretto dryers, the MOISTURE METER device, an exclusive Moretto solution for the precise in-line measurement of residual granule moisture can also be installed on the X COMB series. Moisture Meter analyzes and detects the exact content of residual moisture up to 15 parts per million.

Particular attention is paid to the drying of PET granules, a delicate phase especially for large productions, typical of the rigid packaging and beverage sectors.

In a dedicated area of the stand, Moretto presents a drying system consisting of a XD 800X series dryer combined with the OTX hopper and MOISTURE METER MANAGER. A solution able to guarantee certifiable results, an absolute primacy in terms of energy efficiency for any type of

material and a completely automatic system of the drying process.

With MOISTURE METER MANAGER the drying process goes from an "adaptive" logic to a "responsive" cutting-edge logic.

The innovative turbo-compressors system of the XD 800X series dryer, together with the OTX hoppers, offer extraordinary levels of energy efficiency. Furthermore, the XD 800X dryers do not use either cooling water or compressed air, being this another advantage in the treatment of PET and ensuring energy saving compared to conventional dryers.

The use of the exclusive OTX hopper allows a homogeneous flow of the material inside the hopper during the process, guaranteeing an effective and controlled drying and an extraordinary energy efficiency of + 66%, also reducing the material treatment time. In the treatment of



ERGE Elektrowärmetechnik - Franz Messer GmbH  
 91220 Schnaittach - Hersbrucker Straße 29-31  
 Tel. +49/9153/921-0 Fax +49/9153/921-117  
[www.erge-elektrowaermetechnik.de](http://www.erge-elektrowaermetechnik.de)  
 mail: [verkauf@erge-elektrowaermetechnik.de](mailto:verkauf@erge-elektrowaermetechnik.de)

HEIZEN

HEATING

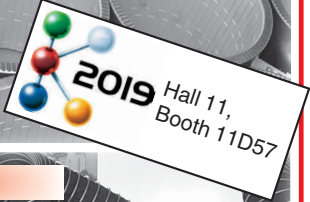

TROCKNEN

DRYING

REGELN

CONTROLLING



ELEKTROWÄRME TECHNIK FRANZ MESSER GMBH



PET in the Beverage sector, one of the aspects to which Moretto customers are most “loyal” is the constant treatment of OTX which ensures a stable process and an improvement in machine cycle times, in the order of half a second.

The application of MOISTURE METER MANAGER integrates the dryer into a “responsive” system as required by the 4.0 intelligent factory project. MOISTURE METER MANAGER measures the initial moisture of the granule and based on this, knowing the precise behaviour of each material, it performs the appropriate drying cycle to obtain the result requested by the customer in terms of final moisture, which is then monitored at the hoppers outlet.

To automatically manage and supervise the entire conveying process of small or large quantities of plastic material, ONE WIRE 3 guarantees the greatest transport efficiency, thanks to its advanced FIFO logic. ONE WIRE 3 also controls those devices, which with their exclusive technologies, contribute to optimizing the granule conveying and feeding process. In particular, the DOLPHIN manifold unit, automatically supplies and distributes all the materials to all the machines, avoiding any risk of contamination and human error.

KRUISEKONTROL, an exclusive Moretto patent, which the European Patent Office (EPO) recognized as “the only automatic and intelligent system in the world capable of defining the best transport conditions for each plastic material”. The uniqueness of this system lies in its ability to manage the speed of the material during the conveying phases, eliminating the peaks and the consequent formation of angel hair and wear of the pipes and adapt in a responsive way the transport conditions, differently from the various inverter systems that simply act on the air speed, but without taking into account the numerous variables that characterize each material (KK controls more than 15 parameters) and which constitute elements of strong differentiation in their behaviour in the pipe.



The DGM Gravix series dosing units are now a standard among customers who seek maximum precision in batch gravimetric dosing even in extreme use conditions. DGM Gravix is the dosing unit that, thanks to its particular control with exclusive Vibration Immunity System and the double eyelid system, doses with precision up to 0.01% even when installed on a blow moulding machine, without being affected by the continuous movements and vibrations to which it is subjected.

The DGM Gravix dosing units cover dosing requirements for granule, powder and flakes materials, with dedicated applications, up to 12 materials and 12,000 kg/h. Applications dedicated to micro dosing, such as Rotopulse, make these machines extremely flexible in their use in the department.

DPK is a compact precise loss-in-weight dosing system, suitable for the dosing of small amounts of masterbatch or additives. The technology of the load cells and the control algorithm, make DPK reaching dosing accuracy of up to  $\pm 0.03\%$ . The masterbatch or additive to be dosed is contained in a hopper built in a specific transparent resistant acrylic material, free from electrostatic charges, which makes immediately visible the content material and the level of load and avoids the stop of material on the hopper walls. The hopper is easily removable without the use of tools and, together with the intelligent storage and recognition system of the masterbatches alongside the machine, the recipe change is even more immediate.

For the supervision and control of plastics processing plants, Moretto has developed the advanced MOWIS 3 supervision system, a modular software capable of adapting to the needs and to the qualitative, productive and managerial objectives of each customer, allowing connectivity

between machines, processes, departments, plants and factories.

MOWIS 3, a proprietary SCADA software entirely developed and designed "in House" is the latest evolution of Moretto's advanced supervision system, an essential tool for efficient and safe production, also of the "lights out" type.

Moretto offers a complete range of thermo and cooling systems to satisfy any production requirement, from single unit on the side of the machine, to ad hoc developed modular open centralized systems with a maniacal attention to total energy efficiency.

The large amount of energy required for cooling processes in the plastics processing industry requires extremely efficient and flexible systems. The X COOLER series of modular chillers was created specifically with these prerogatives. The scalability of the cooling capacity makes it possible to supply the cooling capacity according to the real needs with a consequent drastic reduction in energy consumption, realizing a clear reduction in operating costs. The realization of X COOLER and of the smaller series of machines for installation inside the production plant, saw an obsessive attention to the construction details, which led, in some cases, to not being satisfied with what existed and to the creation of dedicated components to obtain the maximum results in performance terms.

The temperature controllers of the TE-KO series ensure absolute efficiency and precision in automatic temperature control both in the moulds of injection moulding machines and in the cylinders and rollers of the extruders. Reliability, speed of temperature regulation, reduction of consumption and ease of use are the major records of these machines. Available in water, pressurized and oil versions with temperatures up to 300 ° C based on the customer's production needs.

Interactive totems and video walls will animate the Moretto space with contents aimed at illustrating technologies and solutions dedicated to each application sector, together with the various initiatives undertaken by the company, among which the "Be Tomorrow" eco-sustainable activity project focused on: circular economy and development of new energy-saving technologies, recycling, bio-polymers,... Great attention is paid to circular economy, the central theme of K2019. Moretto participates, in collaboration with a well-known OEM, in a demonstration unit dedicated to the production of coffee cups made with bio-polymers: a 100% organic product, washable and reusable up to 500 times.



K 2019: Hall 11, Booth H57  
K 2019: Hall 11, Booth E65

Moretto S.p.A.  
[www.moretto.com](http://www.moretto.com)  
Moretto - Contrex  
[www.contrex.com](http://www.contrex.com)

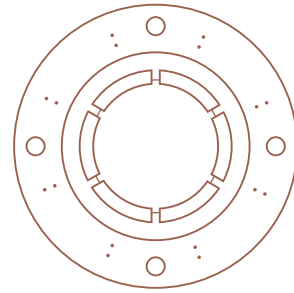

# CCA

The Original

### Innovation is our Passion

CCA offers different adjustable calibration sleeves to optimize your plastic pipe production - from 14 up to 2,600 mm pipe outside diameter. Discover now the individual solution for your needs:

- conventional
- 2-point adjustment
- 1-point adjustment
- 4-point adjustment



We look forward to meeting you!

Hall 10,  
Booth G58



[ccagmbh.de](http://ccagmbh.de)

[hoch5.com](http://hoch5.com)



# New Equipment and Software Applications

Brabender Technologie is showing the full range in Düsseldorf: The company comes to the K 2019 with new equipment, new smart control features and a wide range of proven solutions. Many new developments follow the "Easy Clean" premise – simple cleaning and fast removal for easy product changeovers. Some of the existing equipment was also revised and optimized in this regard. "This year, we are presenting our new and existing designs and ideas both virtually and physically," reveals Bruno Dautzenberg, Managing Director of Brabender Technologie. "Our objective is to illustrate our portfolio and our skills as clearly as possible, not only to make our visitors curious but also to allow them to grasp our solutions immediately."

The equipment will be accompanied by many videos and on-screen applications which will also highlight new control features. "Our new OPC-UA interface is a step

*The new and optimized version of the DSR28, which debuts on the K-fair*

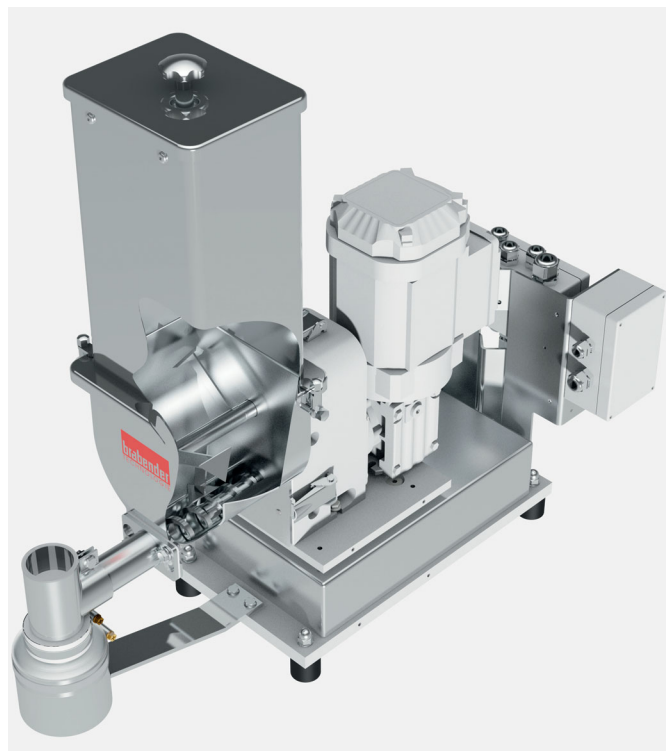

towards Industry 4.0," Managing Director Günter Kuhlmann explains this innovation. Data exchange regardless of manufacturer is an important factor for establishing smart factories. "OPC-UA means improved industrial communication: This interface transmits process and control data in a service-oriented architecture which opens up new possibilities for our customers." The expansion to upstream machines, such as vacuum conveyors, is also now available in the feeder control and the OP16 control unit. This provides customers with a control for both machines from a single source, allowing them to optimize refill processes and ideally coordinate the machines.

**Launch of DSR28 and DDSR20:** The engineers have completely revised two feeder models, the DSR28 and DDSR20. In addition to a new type of gearbox, this new range features many new components which are all compatible with one another and allow easy operation without tools – for easy cleaning. Both machines are displayed at the exhibition and also demonstrate the possible motor types, such as the new motor with extended adjustment range (1:100). "We do not want to reveal too much about these two feeders before the trade fair," explains Bruno Dautzenberg. "But visitors can expect some surprises, as the concepts are completely new developments."

The exhibition highlights at a glance:

- The new FiberXpert fiber feeder for lower feed rates
- A FlexWall® 40 with acrylic plastic container which can be controlled with a mobile device using a web server application
- The unusual version of a feeder with twin screws based on special customer requirements
- The DS feeder range for granulate presented this year
- Proven products from the portfolio such as the liquid feeder or a feeding channel



K 2019: Hall 10, Booth A41

# New Standards in the Field of Optical Profile Measuring Systems

ASCONA stands for quality, service, safety and efficiency in the field of optical profile measuring. Since 1988, located in Meckenbeuren, Germany.

ASCONA's systems are designed for fast, easy, and reliable profile measuring – in the lab or directly at the extrusion line. Their product portfolio begins with the starter models for discrete measurement of profiles in the lab, the promex BASIC FAST and promex ADVANCED FAST systems. The perfect solution for quality control inspection of profiles directly at the extrusion line is the promex EXPERT system. The high-end models are not sensitive to vibrations, temperature fluctuations, or dust – they are designed and intended to be used on the production floor.

These measurement systems lead to quality improvement, reduction in scrap rates, cost savings, and increased productivity.

Based on customer requests ASCONA is introducing two brand new measurement technologies: promex tooling plate measurement. ASCONA now has

a measurement system available not only for measuring profiles but also for measuring the tooling plates.

And promex coextrusion measurement: Also the coextruded profiles are no longer an issue for measurement. ASCONA is now able to measure two different material layers, even if there is no visible color difference. This new technology was developed based on some of the customers that started to mix fluorescent powder into the inside (recycled) material of their profiles.

In addition to ASCONA's dimensional measuring systems the company now has a solution available for the inline surface inspection of plastic profiles which is integrated directly into the extrusion line.

The promex CSI PVC is designed to detect surface defects like grooves, spots, and streaks, as well as to sort them out, providing hands free 24/7 quality control.

promex CSI PVC is not only able to detect errors on white profiles but also on profiles with a light grey or brown color.



*promex EXPERT – for dimensional profile measuring at the extrusion line*

ASCONA's promex solutions will provide the customer with the most user-friendly, highly accurate, and fast measurement results, all built with unbeatable quality and industry leading support.

ASCONA systems are a key to quality – 100 % made in Germany.



**K 2019: Hall 10,  
Booth D49**

**ASCONA GmbH**  
[www.ascona.de](http://www.ascona.de)

AUTOMATIK  
 ETLINGER  
 GALA  
 MAAG  
 REDUCTION  
 SCHEER

# NEXT LEVEL SOLUTIONS

Integrated Systems for Polymer Processing

PUMPS & FILTRATION SYSTEMS >  
 PELLETIZING SYSTEMS >  
 PULVERIZING SYSTEMS >  
 RECYCLING SYSTEMS >

MAAG Group is the Partner for the Polymer Processing Industry worldwide. All of our integrated solutions from Pump and Filtration Systems to Pelletizing and Pulverizing systems to Recycling Systems have an outstanding performance for demanding customer requirements.

maag.com

**JOIN US IN DUESSELDORF**  
 K 2019, 16.10. – 23.10.2019  
**HALL 9**  
**BOOTH A04**

a DOVER company



# Mixing System and Container Mixer



PLAS MEC will be exhibiting at K 2019 after its fiftieth anniversary. In Düsseldorf PLAS MEC will show a MIXING SYSTEM type 'COMBI-MIX-HC-800/2500' made with the technology consolidated in years of experience and including the latest development in terms of safety which is becoming more and more important in the last years.

PLAS MEC will also show one CONTAINER MIXER type 'TRR-1500/FV' compliant with the ATEX Directives, suitable to mix additives with potential explosion risk and to be installed in classified area.

PLAS MEC is an Italian Company manufacturing equipment and accessories for the mixing of plastic materials (PVC, PE, PP, ABS), technical and special polymers (PA, PC, PU, PET, PTFE and others), powder coatings resins, wood-plastics composites, masterbatch, additives, pigments, thermoplastic rubber etc. The Italian company is recognized from years as a world leader in the manufacturing and supply of mixing systems for plastic powders. Af-

ter 52 years from the foundation, PLAS MEC has manufactured over 6000 machines delivered all over the world.

One of the distinguishing features of the company is its flexibility in designing and providing high-tech solutions "tailored" to the customer. PLAS MEC is known for manufacturing sturdy, long-lasting machinery that maintains the highest levels of production quality. This also stems from the decision to maintain a key part of the production within the company, so as to keep a watchful eye over every detail of the machinery.

PLAS MEC manufacturing range comprises mainly the following:

- COMBIMIX HC which is the ideal solution for any technical mixing requirement in the field of PVC or WPC dry blend production. COMBI-MIX-HC versions span from 200/800 to 2500/8500 liters capacity. A very high output can be achieved thanks to the optimized design of the High Speed Mixer type "TRM" and the High-Efficiency Cooler type "HEC"

that features the latest technologies of thermofluidynamic engineering.

- CONTAINER MIXER 'TRR' which is the ideal alternative to conventional turbomixers for masterbatch, pigments and technopolymers preparation, when production conditions require a high degree of versatility and a wide range of different recipes to be mixed with the same machine.

The range of production is completed by a wide range of accessories to transport, weight and store the powders, as well as the complete automation to control the process, in order to be able to give to our customers a complete solution and a fully automated mixing system.



2019  
16-23 October  
Düsseldorf  
Germany

K 2019: Hall 9, Booth A60

PLAS MEC S.R.L.  
www.plasmec.it



# Single-Screw Extruder for Small Pipe and Profiles with New Control Unit

No other extruder has experienced the same level of commercial success as the standard alpha extruder from Vienna-based firm battenfeld-cincinnati. First introduced as a true innovation at the K trade fair in 2001, this cash-and-carry single-screw extruder for small technical profiles and pipe is available ex stock at a standard price worldwide. Eighteen years later, over 1,200 extruders are now in use and demand remains high. The latest innovation to be presented at this year's K trade fair is the alpha plus: the alpha extruder featuring the new BCtouch UX compact.

From a process engineering perspective, the tried-and-tested plug-and-play extruders remain unchanged. These well-equipped processing machines are used as universal extruders to produce small technical profiles or small pipe, while also being employed as co-extruders in other applications. Thanks to their sophisticated design, these extruders are especially compact and are particularly suitable for use in production halls with limited space. The alpha extruders are available in sizes of 45, 60 and 75 mm as standard models with the option to incorporate a feed zone with either fine or coarse grooves.

The new control unit is being unveiled for the first time at this year's K trade show. Up to now, alpha extruders have been fitted with a relay control as standard. Now, the optional plus version comes equipped with the BCtouch UX compact control system. First presented at K back in 2016, the BCtouch UX – fitted as standard in all battenfeld-cincinnati extruders – has since been developed into an advanced control solution, and forms the basis of the new control system. The BCtouch UX has firmly established itself in the market thanks to its simple and intuitive operation and optimized software. Its little sister, used in alpha plus extruders,



Alpha plus extruder

comes with a 12" screen, providing a clear overview of all the necessary features. Pop-ups for settings and data entries mean that the system can be operated with limited training. A high-performance temperature-monitoring module is integrated in the compact control system, which comes is critical for temperature-sensitive raw materials. Two systems can also be integrated in order to keep energy and material costs to a minimum. The alpha plus extruder is the perfect solution, combining a cost-effective and readily available standard extruder with a modern, intuitive, and easy-to-operate control system boasting a wide variety of options. As before, the version with relay control is available in the "alpha basic" variant. The modular structure of the newly developed control cabinet also makes it possible to retrofit the BCtouch UX compact at a later date.



K 2019: Hall 16, Booth B19

battenfeld-cincinnati  
www.battenfeld-cincinnati.com



- optical profile measuring for PVC and aluminium profiles
- dimensional measurement • surface inspection

## NEW

- **promex CSI** for plastics  
inline surface inspection for plastic profiles
- **promex** tooling plate measurement
- **promex** coextrusion measurement

**HALL 10 / BOOTH D49**



# Pioneering Circular Economy

KraussMaffei continues to blaze the trail as a technological pioneer in the preparation and reuse of recycled plastics. For more than three decades, the company has been preoccupied with recycling in research and development and acknowledges this strategic focus also at this year's K trade fair.

Packaging products fulfill their duty quickly. So, why not use them as raw material for new high-tech articles – in the automotive industry, for example? At K 2019, KraussMaffei is demonstrating how a bucket turns into a premium-quality panel of an A-pillar with over-molded fabric surface. A ZE 28 BluePower twin-screw extruder makes this possible by upcycling the material. Under the keyword of the circular economy, KraussMaffei is linking its EXT (Extrusion), IMM (Injection Molding Machinery) and DSS (Digital & Service Solutions) business units at the trade fair. The GX 1100 injection molding machine with a clamping force of 11,000 kN, newly presented at the K trade show, produces buckets made of polypropylene, which are then shredded externally and fed back into the material circuit as regrind. Under the EdelweissCompounding brand, a ZE 28 BluePower twin-screw extruder produces technically enhanced recompound from it. For this purpose, pigments and a 20-percent proportion of talc are added to the polypropylene flakes. After underwater pelletizing and drying, the recompound is again available at high quality and with property patterns adapted to the following injection molding application. A material feeder conveys the polypropylene to the all-electric PX 320 injection molding machine, and then the polypropylene is formed in the cavity into a panel for an A-pillar. The component surface forms an over-molded layer of fabric.

EdelweissCompounding is intended to make on-site compounding more attractive to recycling companies and plastics manufacturers. KraussMaf-

*A bucket becomes an A-pillar by means of circular economy – At K 2019, KraussMaffei is presenting a closed material and production circuit involving extrusion and injection molding machinery (Photo: KraussMaffei)*

fei is the only company in the market that covers most of the plastic value chain. "We view ourselves as enablers of circular economy for our customers so that they can be successful as part of this economy," explains Matthias Sieverding, President of the Extrusion Technology Segment at KraussMaffei. The Extrusion business area produces raw materials and semifinished products; Injection Molding Machinery – in combination with the respective automation – enables efficient production of high-tech components before extrusion takes its turn again to recycle these products.

Both in extrusion and injection molding, the third participating business unit at the K trade show is making its entry: Digital Service & Solutions with products such as APC Plus (Adaptive Process Control) and DataXplorer. APC Plus monitors the injection molding process and adapts it continuously to balance interference factors such as fluctuations between batches and in climate or changing recompound percentages. In injection molding, this is done via the material database stored in the machine and the online analysis of the melt viscosity and also by adjusting the holding pressure changeover point and the holding pressure level even within the same cycle. In extrusion, the melt temperature, pressure and screw speed are recorded.

The DataXplorer makes a detailed view of the depth of the process possible because it is capable of storing up to 500 signals every 5 milliseconds as

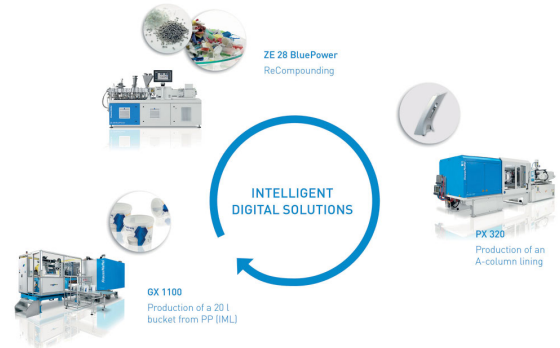

graphs—for instance, signals from the machine or the mold.

All data resulting from this is routed to the new data system, which is being introduced at K 2019. It is a central data collection point for all components within a production cell, which includes peripherals and automation. The customer can collect all information required for production monitoring and production flow control. Data export (for instance, to MES or ERP systems) is easy and can be implemented in a modular structure. Digital services help ensure the quality of production and products, prevent rejects, and thus also contribute to resource-conserving production.

Leading role in the implementation of circular economy KraussMaffei's increased involvement in the field of circular economy is motivated by ecology and developments in society. "KraussMaffei is aware of its responsibility and, as one of the world market leaders, wants to occupy a leading role in the areas of recycling, upcycling and recompounding of plastics," declares Sieverding. Therefore, KraussMaffei is enhancing its joint effort with partners and customers to develop new business units regarding the reuse of plastics.



2019  
16-23 October  
Düsseldorf  
Germany

K 2019: Hall 15, Booth C24

KraussMaffei Technologies GmbH  
[www.kraussmaffei.com](http://www.kraussmaffei.com)



Automatically Centering Double Crosshead  
(Photo TROESTER)

# Compact Extruder

Since more than 125 years, TROESTER stands for outstanding quality Made-in-Germany when it comes to developing and manufacturing innovative and reliable machines for the rubber industry. In the world of rubber and plastics processing, TROESTER is known for its flexible responses to customers' requirements and collaborates with them to produce high-quality, tailor-made solutions. Process and manufacturing specialists will be on hand to talk to stand visitors about the latest developments in detail. One of the products TROESTER will be presenting is a 90 mm compact extruder and a cross head that centres automatically for making hoses in superior quality. This machine has already gained a firm footing on the market and was the basis for TROESTER's latest development: the automatic centering double crosshead. The double crosshead allows the production of two layers simultaneously, each centred by servo-hydraulic systems that operate independently. Combined with a SIKORA X-ray machine, the system automatically regulates the centricity of the layer(s).

To complete the portfolio for hose production equipment, a straight extruder head was developed which also centres automatically. From now on, TROESTER customers can choose between automatically centering straight heads, crossheads and double crossheads to improve the quality of their production and products. Further benefits this new technology entails are material efficiencies, better product tolerances and quicker set-up times.

As a member of the TROESTER Group, X-Compound will also be on the stand to present its kneading technology for uninterrupted production of HFFR, PVC or XLPE com-

pounds. The Swiss subsidiary specialises in planning and constructing machinery for processing plastics which involves steps such as conveying, melting, dispersing, mixing and degassing.



K 2019: Hall 16, Booth F40

TROESTER GmbH & Co. KG  
[www.troester.de](http://www.troester.de)

## PLASTICO

Supplier of new and used plastic processing machines

**Compounding & Recycling Lines**  
**Single and Twin-Screw Extruders**  
**Laboratory Machines, Shredder-Pelletizer-**  
**Granulators, Dosing equipment & Accessories**  
**Screen-pack-changer, Injection Moulding Machines**

**20 min. from K-SHOW 2019**

**PLASTICO TRADING GmbH & Co. KG**  
Vohwinkel Str. 173 • D-42329 Wuppertal (Germany)  
Phone: +49 (0) 202 – 273 275  
e-mail: [service@plasticotrading.de](mailto:service@plasticotrading.de)  
[www.plasticotrading.de](http://www.plasticotrading.de)



*The new generation of Plastex vacuum systems for extruder degassing is ready for Industry 4.0 (Picture: Busch Vacuum Pumps and Systems)*



# New Generation of Extruder Degassing Systems

Busch Vacuum Pumps and Systems will present the latest generation of Plastex vacuum systems for extruder degassing for the first time at K 2019. The new Plastex vacuum systems can be programmed and monitored via a display. They are fully connected in order to exchange data with the extruder control system and can be operated directly via the extruder. The fact that all components are connected means that Plastex vacuum systems are ready for Industry 4.0. The degassing system is controlled as required by a frequency-controlled drive motor. This means that the programmed vacuum level is precisely maintained – the energy saved in the process is a further benefit.

In recent years, Plastex vacuum systems have become widely established for degassing the melt in the screw zone of extruders. The model presented at K 2019 is equipped with a Mink claw vacuum pump. These vacuum pumps operate dryly, i.e. they do not require any operating fluids such as water, which can lead to high costs for treatment and disposal.

With the new generation of Plastex vacuum systems, Busch now impresses with further benefits. Thanks to

the demand-dependent control and the option to adjust the vacuum level precisely to the material to be extruded, the extruder and the temperature conditions, it is possible to reproduce product quality without having to readjust the vacuum level manually via valves during the process. Plastex vacuum systems are available in different configurations and sizes. They are suitable for both compounds and master batches. They can be used to degas polyolefins such as PP/PE, EVA, PBT, ABS, EVOH or POM. Even the degassing of recycled material does not pose a problem for Busch's new Plastex vacuum systems. A flushing device allows to clean the vacuum pump after or during the process. It is also possible to program the cleaning intervals and the dosing of the cleaning agent.

The new Plastex vacuum systems' control system also permanently monitors the condition of the filters and separators and immediately informs the operator via the display or extruder control system if, for example, a filter needs to be cleaned or condensate needs to be drained from the after-separator or the condensate collection container. The operator therefore always has an over-

view of all operating parameters. Any necessary action steps are immediately displayed to the operator. This increases reliability, simplifies operation and minimizes maintenance costs.

Busch's Mink claw vacuum pumps have not only established themselves in the degassing of the melt during extrusion; this vacuum technology has also become the state of the art for pneumatic material feeding. Busch will present the latest development in Mink claw vacuum pumps at the trade show booth: the Mink MV 0600 B is equipped with a frequency-controlled drive motor as standard and can therefore adapt the pumping speed to the actual requirements. This means that not only can the material be transported as gently as possible, but further energy and cost savings are also possible.



K 2019: Hall 9, Booth E23

Busch Vakuumpumpen und Systeme  
www.buschvacuum.com

# Slitting and Winding Solutions for Film Manufacturers and Converters

Plastics and rubber industry professionals will be able to explore a "world of pioneers" and the Universe of GOEBEL IMS at the K 2019 in Dusseldorf, Germany. GOEBEL IMS will present developments for the film manufacturing and converting industries that go beyond slitting and winding machines. The manufacturer will exhibit a brand-new machine as the result of its intense research and development work around flexible packaging technologies. The newest addition to the comprehensive portfolio of state-of-the-art slitting and winding solutions will surprise the visitors with its completely new and modern design. Further, it fulfills the industry's latest demands for performance and precision. Requiring only minimum operative space and investments, the compact center driven dual-shaft slitter rewinder is small in size, yet big in technology. Available either as a basic machine or with advanced technical functions and customized features, the new slitting and winding solution converts mother rolls with widths between 1,000 and 1,600 mm at production speeds of up to 600 m/min. Some machines have already been commissioned by film manufacturers and converters.

In addition to GOEBEL IMS' newest machine innovation, trade show visitors can experience the comprehensive primary portfolio of slitting and winding solutions combining high performance and top quality with cutting-edge technology. With impressive working widths of up to 12,000 mm, the MONOSLIT GIANT is the superlative primary slitter for film producers. It can process a broad spectrum of film, such as BOPP, BOPET, OPP, CPP, BOPA, BOPS, and other special films at speeds of up to 1,500 m/min. It is designed for a broad range of applications, including packaging and capacitor films, battery separator and optical films. With GOEBEL IMS' INTERSLIT, outstanding results in the production of narrow rolls, starting from a minimum slitting width of 180 mm, at top speeds of up to 1,200 m/min are guaranteed. Though sounding similar, INTERSLIT BSF is truly different. This primary slitter rewinder is dedicated to processing ultra-sensitive materials such as battery separator films and wet processed BOPE-based battery separator films with web widths of up to 6,000 mm. Rounding off the portfolio of innovative primary slitter rewinders is the XTRASLIT 2. Since its introduction, this high-end machine provides film and flexible packaging manufacturers with maximum performance, precision and flexibility and has thus been enjoying growing popularity, especially among CPP film producers and metallizers.



GOEBEL IMS: XTRASLIT 2

"Offering outstanding solutions for the whole production chain is our aspiration. Therefore, we are continuously investing in the development of cutting-edge slitting and winding machines for both film manufacturers and converters. We are very happy to present our latest innovation as well as our new service philosophy at K 2019," states Daniele Vaglietti, Managing Director Sales and Marketing of GOEBEL IMS' parent company IMS TECHNOLOGIES GROUP.



K 2019: Hall 3, Booth B73

GOEBEL IMS  
www.goebel-ims.com

## PLASTIK-MASCHINENBAU GENG-MAYER GMBH

**RAM-Extruders**  
**Screws**  
**Barrels**



Hall 17,  
Booth A74



www.plastik-maschinenbau.de  
info@plastik-maschinenbau.de

Im Rotergarten 1  
D-53539 Bongard  
Tel.: +49(0)2692/1702  
Fax: +49(0)2692/1844



# Cast Line for Stretch Film Production

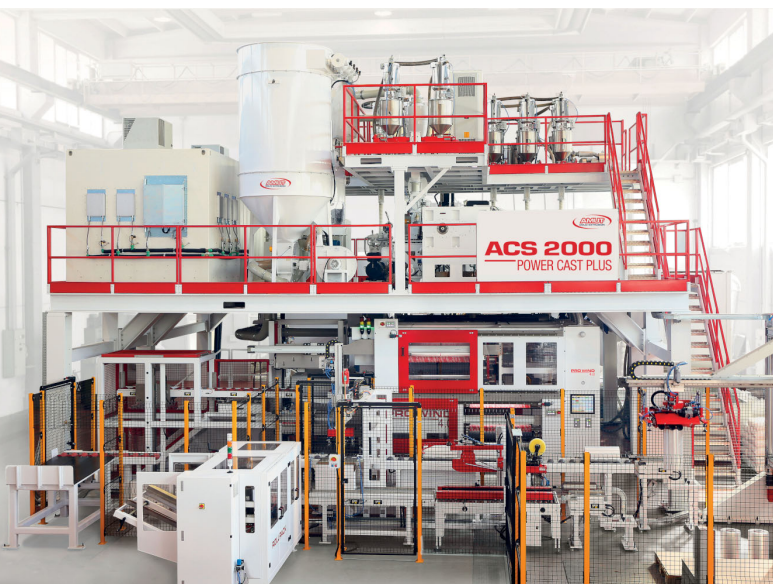

AMUT GROUP will present in operation the brand-new ACS 2000 cast line for stretch film production. Most awaited is the Q-Catcher, the recent developed patented system.

The Q-Catcher concept has been presented this year during the Stretch Film Conference in Barcelona, the Plastics Extrusion World Expo held in Cleveland, Ohio and the Chinaplas exhibition in Guangzhou but only the K Show will host its demo live for the first time.

The Q-Catcher permits the repetition of previously saved parameters with the reproduction of the film having exactly the same mechanical properties.

The ACS 2000 has a 7-layer – 5-extruder configuration and an useful width of 2.000 mm. The output is around 1.300 Kg/h and the film thickness has a range from 6 to 25  $\mu$ . Production speed of 850 m/min and mechanical speed up to 1000 m/min. The upgraded technology includes the T-Die Essentia (AMUT branded) with die splitter, movable vacuum box for cleaning without dismantling, jumbo type chill roll unit 1500+450 mm diameter, AD Scan X-Rays thickness control system, the Prowind 4.0 super-fast winder for hand, machine and jumbo rolls without any hydraulic components.

## Recycling – “Go Green” corner:

AMUT GROUP carries on with the motto “Go Green” firstly launched during Chinaplas 2019 edition and offers several solutions to support the circular economy.

The friction washer, patented machine exhibited, performs intense PET/HDPE/LDPE washing and pollutants removal action. Thanks to the strong cleaning force of the friction washer, the outgoing flakes have the quality required to be re-used in many applications.

Great visibility will be dedicated to the project carried out in partnership with Ecoplasteam Italian company for the POAL (Tetrapack® waste) recovery. POAL, coming from the paper mill after being sorted from cellulose, is washed and pelletized into Ecoallene material. The entire treatment process is completed with AMUT equipment. Ecoallene pellets are suitable to be extruded and thermoformed or processed by injection molding as well.

AMUT also proposes the line concept for Bottle to Packaging application developed in collaboration with Erema. The extrusion line is designed to process 100% post-consumer PET bottle flakes into single layer foil certified food grade thermoforming foil. Direct FDA extrusion process.

The line has a net width from 1,000 to 2,000 mm, configuration with one layer, three layers or up to 5 layers upon request. The thickness is from 0.15 to 2 mm and the output is up to 2,000 kg/h.

## In-line thermoforming plant for PLA cups will be video shown:

The AMUT technology – both extrusion and thermoforming units – can handle production with easy and fast change from PP to PLA.

Thermoforming – AMUT-COMI booth: The ACF820 thermoforming machine to be presented at K Show has three stations – forming / cutting / stacking, mould size of 820 x 650 mm and includes the following options:

- additional chain rails spreading point between the oven and the forming mould
- 80 ton forming press for integrated forming and cutting
- 80 ton cutting press
- real time monitoring of the clamping force for forming and cutting station
- pick and place stacking robot model ER3X
- vision system for quality control.

The ACF820 will be in operation with 100% r-PET foil produced with the above-mentioned AMUT/Erema line. Demo also with metallized foil in GLUE LESS™ technology. The 4-cavity mould is for a dinnerware set composed by a charger plate and a soup plate.

ACF series is driven by EASY software, the smart HMI developed by AMUT-COMI software engineers.



K 2019: Hall 3-B92

AMUT GROUP  
www.amutgroup.com

# Fine Mesh Straining of Rubber Compounds for the Highest Requirements



*roll-ex® 1000 TRF:  
Fine Mesh Straining in a new dimension with throughput rates of up to 10000 kg/h*

**Innovative solutions for the gentle and clean processing of rubber- and silicone compounds at the Expo K 2019:** UTH GmbH from Fulda/Germany will be presenting its extended product range. In addition to the proven roll-ex® gear pump technology and innovative roll-ex® fine mesh straining solutions, this includes current developments such as the TRP (Two-roll Plasticiser) for rework processing, polymer dosing system and roll-ex® MDSE technology for silicone compounding. Their main focus is the presentation of a highly cost-effective and innovative solution for the fine mesh straining of final rubber- and silicone compounds. This subject is highly topical in view of the fact that rubber processing presents enormous challenges to rubber manufacturers. The demand is for products of the highest quality as well as greater cost-effectiveness. The roll-ex® extrusion system developed by UTH has become a benchmark

for fine mesh straining of rubber compounds worldwide: the proven roll-ex® gear pump technology permits the particularly gentle extrusion of rubber and silicone and an easy, quick compound change. UTH's innovative solutions are used in different areas of the rubber manufacturing, for example in complete offline straining cells (consisting of strainer, strip cooler and stacking and packing device) or in the mixing line for final compounds. In the process, the modular roll-ex® system can be combined with a two-roll feeder (TRF), a screw feeder (SF) or a conical twin screw feeder (DSE). Apart from fine mesh straining, precise extrusion is another primary application of roll-ex® gear extruders and gear pumps for which high working pressures of up to 800 bar can be applied. UTH can offer, among other things, system solutions (including the supply of complete lines) for the manufacture of rubber-coated wire, yarn or fibre

components. Depending on the particular application and requirements UTH can provide these machines in different customer-specific designs. The range of intelligent upstream and down-stream equipment, which enables seamless integration in mixing lines of all sizes, is just as much a part of the scope of supply as the comprehensive after sales service. Using an exhibit to explain the process, UTH will be providing further information about the particular benefits and possible applications of roll-ex® gear pump technology and innovative fine mesh straining solutions.



**K 2019: Hall 15, Booth D41**

**UTH GmbH**  
[www.uth-gmbh.com](http://www.uth-gmbh.com)



**HIGHLIGHTS IN  
HALL 17, STAND A 40**

**GRAEWE**  
**XTRAS FOR EXTRUSION**

DEFINING  
PROGRESS



[www.graewe.com](http://www.graewe.com)

GRAEWE GmbH  
Max-Planck-Straße 1-3  
79395 Neuenburg am Rhein  
Tel. +49 (0) 7631/7944-0



# “Creating Change Together”

This year's plastics trade show is to be dominated by the circular economy. Alongside digitalization, recycling and sustainability are among the central topics of the industry. Many exhibitors will present solutions that help to make production more sustainable. This also includes the Bonn-based company Kautex Maschinenbau, one of the world leaders in the production of extrusion blow molding machines. With the slogan “Creating Change Together”, the company will present various technologies, such as a newly developed extrusion head that drastically reduces the consumption of raw materials when changing color and material.

**Live demonstration of highly efficient bottle production with PCR:** The sustainable aim while developing the new extrusion heads was to enable significantly quicker color and material changes, as laborious purging or cleaning not only takes time but also consumes material. At the Kautex booth, visitors will be able to see for themselves how the new generation of extrusion heads work and where the potentials for saving are. To serve as an example, an all-electric KBB60 blow molding machine will demonstrate the production of a sustainable three-layer bottle containing PCR in live production. The materials processed are supplied by the renowned manufacturer Braskem. To reduce the consumption of raw material, a mixture of polyethylene (I'm green™) and PCR is also foamed in the middle layer. Kautex, together with the Brazilian plastics material manufacturer, selected the raw materials to achieve a significantly improved carbon footprint as an additional benefit. What's more, the bottle has a neutral odor despite the use of PCR. To complete the production cycle, the company Er-ema will recycle the bottles produced during the trade show. The location

(© Kautex  
Maschinenbau  
GmbH)



of this live recycling demonstration will be the Erema “Circonomic Centre” in the outside area where the circular economy will be brought to life for the trade show visitors.

**New digital services at the Service Point:** At the “Service Point,” Kautex will present its new digital solutions in customer service. With the new augmented service, Kautex customers will have the opportunity to examine machine faults together with Kautex service technicians within the shortest time possible. This means that teams of experts all over the world can directly examine the machine in a virtual environment in order to solve a problem. Kautex has also set up a new portal for ordering replacement parts. In future, customers will be able to identify the replacement parts required for their machine online via “Kautex Spare Parts” and immediately check availability and prices, making the order process and re-ordering significantly easier. Visitors to the Kautex booth will have the chance to familiarize themselves with these new digital services at the Service Point. What's more, there is a new development for Kautex virtual machines – first presented at K 2013 – which are digital twins of machines used as simulators. The virtual machines are now interactive and require machine operators to react appropriately to changes in machine process settings. An error-free article is only displayed if the settings are correct.

## Shuttle service to plant tour in Bonn:

Kautex will offer individual plant tours in the company's Bonn headquarters during the trade show. A shuttle service will transport visitors who are interested to visit the company's facility in Bonn in around 50 minutes. Here, Kautex runs one of three global development centers, known as Technikum. Machines for the entire range of applications are available at the Kautex Technikum, some of which can be seen in live operation. At the Technikum, Kautex presents various bottles made from PCR materials sourced from different manufacturers that are undergoing testing as part of long-term experiments with PCR processing. In addition, there will be a demonstration of a new approach for creating a barrier layer on the inner surface of hollow containers by plasma coating. In this way, the CoEx process that would otherwise be necessary is avoided. Visitors will also have the chance to see a variety of machines types in the assembly halls. A personal guide will take guests on the tour and provide detailed information. Visitors to K 2019 can find out more about services and book plant tours at the Kautex booth.



2019  
16–23 October  
Düsseldorf  
Germany

K 2019: Hall 14,  
Booth A16/18

Kautex Maschinenbau GmbH  
[www.kautex-group.com](http://www.kautex-group.com)



Double-sided Corona treater  
for extrusion and converting applications

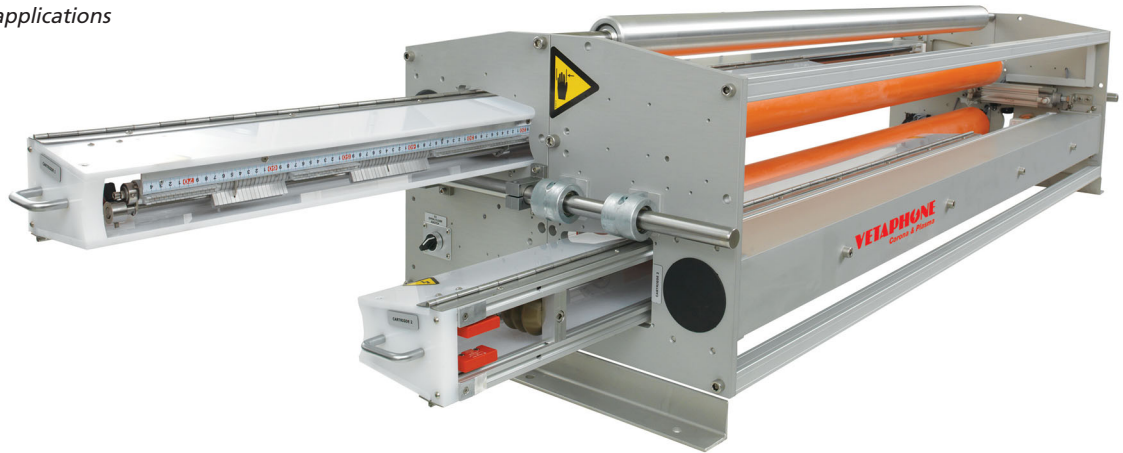

# Treatment Technology for the Plastics Industry

Vetaphone, the Danish manufacturer and pioneer of Corona surface treatment will be displaying a diverse range of surface treatment technology for the plastics industry at K 2019 in Düsseldorf, Germany.

Four standard Corona units from its extensive portfolio will be on static display: The VE2-B model is for extrusion and converting applications, capable of double-sided treatment. The VE1-D and VE1-E models are also for extrusion and converting applications, but capable of distributing a higher power charge or running at higher speeds than the B model. The last unit on display is the VE1-L; a compact model de-

State-of-the-art control panel available  
on all Vetaphone Corona treaters



signed for lamination environments where space is at a premium.

All four Corona units are equipped with Vetaphone's state-of-the-art ICC7 control panel that logs function and maintenance and has remote access for performance and fault analysis. By using a proprietary hardware interface, all Vetaphone Corona systems can be controlled centrally from the main machine HMI, allowing one operator to manage several lines at the same time.

Vetaphone's continuous development of surface treatment technology and intelligent control are part of the company's strategic plan to allow its customers to move beyond industry 4.0. CEO Frank Eisby explains: "Many see the integrated display as the end-game – we see it as the beginning and have made it available on our ICC7 unit since 2017. The aim is to make the use of our technology completely intuitive, simplifying the control of the Corona process as much as possible". To achieve this, Vetaphone has drawn extensively on feedback from its customer database to refine control to its most logical and optimum point.



Hall 10, Booth A59

Vetaphone  
www.vetaphone.com



# New BRUGGOLEN® Additives overcome Performance Boundaries

At K 2019, Brüggemann will present its latest developments in performance-enhancing, cost-effective additives for both virgin polyamides and polyamide recyclates. The innovations range from efficiency-increasing flow enhancers for shorter cycle times and thinner wall thicknesses, through new heat stabilizers for medium to very high temperatures, to reactive additives for the production of recyclates which match the quality of virgin materials.

BRUGGOLEN® TP-P1810 allows for the first time a significant improvement in flow properties of polyphthalamides (PPA, such as PA6T, PA6T/6I, PA6T/6.6 etc.) while retaining overall mechanical property characteristics. Compounders and injection molders can thus significantly widen the processing window and combine high cost efficiency with application-specific optimization. For example, it is possible with BRUGGOLEN® TP-P1810 to reliably produce and easily process compounds with very high fiber contents (e.g. 60 %). Together with BRUGGOLEN® TP-P1507 for aliphatic polyamides (such as PA6, PA6.6, PA12 etc.), which was first introduced at K 2016, Brüggemann offers flow enhancers for all polyamide types. Producers and processors of the corresponding compounds will benefit from much shorter cycle times. Furthermore, both flow enhancers allow the production of large or complex parts with long flow paths and/or low wall thicknesses.

Brüggemann underlines its recognized development expertise and its ability to offer solutions for all stabilization tasks by bolstering its already extensive existing product range with exciting and unique antioxidants which are launched at K 2019.

- Phenolic Plus BRUGGOLEN® TP-H1803 fills the price and performance gap between existing phenolic-based and copper-based stabilizer blends. It improves long-term heat aging stabilization compared to conventional phenolic systems, extending the temperature range to reach peaks of 180 °C, something not possible with standard phenolics.
- In cases where long-term resistance at elevated temperatures up to 180 °C is a priority, Brüggemann offers BRUGGOLEN® TP-H1607, a new high-performance and cost-effective copper iodide-based stabilizer. Based on proprietary technology, its effectiveness significantly exceeds that of the traditional copper iodide/potassium iodide stabilizers without making any compromises in terms of material properties. As a result, the required thermal protection is reached with very low concentrations – a particular advantage in E+E applications.
- With the new BRUGGOLEN® TP-H1805, Brüggemann offers the opportunity to stabilize fiber-reinforced aliphatic



polyamides for long-term use at temperatures up to 200 °C for PA 6 or up to 230 °C for PA 6.6. This enables compounders to tailor-make products for applications in borderline areas that were until now the preserve of polyphthalamides or other high-performance polymers such as PPS.

As an established manufacturer of high-performance additives for polyamides, Brüggemann offers a broad portfolio for the recycling of these polymers. The range covers long-term heat agents, processing stabilizers, flow enhancers, reactive chain modifiers, nucleating agents and other functional auxiliaries. Upcycling for high-quality applications necessitates the targeted selection and combination of these additives. Especially important are reactive chain modifiers that enable molecular weight and viscosity to be precisely adjusted to suit the needs of any particular application.

- BRUGGOLEN® M1251 compensates, through linear chain lengthening, any decline in molecular weight during previous processing, and thus improves the mechanical properties of the recyclate to match those of virgin material. BRUGGOLEN® M1253, available as a smaller pellet size of the same additive, makes for easier dosage during compounding.
- BRUGGOLEN® TP-M1417 specifically shortens excessively long molecular chains of high-viscosity polyamide scrap, e.g. from extrudate, fibers or cast polyamides. Only small quantities and a single extrusion step are sufficient to produce high-grade recyclate that is optimally suited for injection molding and with performance properties that match those of virgin material.

These chain modifiers are particularly effective in enabling secondary PA material to meet high quality specifications and, as a result, help to meet the need for increasing recycling quotas.



K 2019: Hall 8a, Booth D08

► L. Brüggemann GmbH & Co. KG  
www.brueggemann.com



**Chinaplas® 2020**  
国际橡塑展

The 34<sup>th</sup> International Exhibition on Plastics and Rubber Industries

2019 | Booth No.: EN1-02  
Visit us to win fabulous gift!

# Smart Manufacturing · Innovative Materials · Green & Circular Solutions

@The World's Leading Plastics & Rubber Trade Fair

## 2020.4.21-24

National Exhibition and Convention Center, Hongqiao, Shanghai, PR China

- Exhibition area 340,000 sqm
- 3,900+ global exhibitors
- 1,100+ material suppliers
- 3,800+ machine exhibits

[www.ChinaplasOnline.com](http://www.ChinaplasOnline.com)

@CHINAPLAS    @chinaplas\_1983



ORGANIZER



CO-ORGANIZER



SPONSOR



OFFICIAL PUBLICATIONS AND ONLINE MEDIA



(852) 9602 5262

Email : [Chinaplas.PR@adsale.com.hk](mailto:Chinaplas.PR@adsale.com.hk)  
Adsale Plastics : [www.AdsaleCPRJ.com](http://www.AdsaleCPRJ.com)  
Adsale Group : [www.adsale.com.hk](http://www.adsale.com.hk)



*COLOUR VISION is a colour concept in keeping with the times and which presents innovative colours, effects and surfaces in selected polymers in the form of plastic lens plates (Photo: Gabriel-Chemie)*

## Color Masterbatch

The Gabriel-Chemie Group will present itself with a new booth design as well as numerous new, innovative solutions and product demonstrations. The main topics are digitalisation and sustainability.

With the launch at the Fakuma 2018 of the custom developed platform Master Of Batch™ the product sector of Gabriel-Chemie was penetrated by the digital and networked world. The Smart Search Tool launched last year with Master Of Colours and will be complemented this year with the extension Master Of Additives.

A product line that enables information to be generated in plastics in a way that ensures material definitions as well as the identification of all individual parts. In other words, plastic parts are provided with an individual DNA, a signature for identity like a fingerprint. This combination is useful for all stages of a product cycle – if it is in manufacturing, quality management, the supply chain or the circular economy of raw materials at the end of a product life – every single step, from production to distribution, is traceable. The product authentication and any security concerns are ensured by appropriate markers or so-called taggants.

This new product series is therefore called Taggant Technology Series – in short TagTec and is offered, in addition to predefined application mod-

ules, as a customised solution for specific requirements.

An overview of the basic functionality of the TagTec series and a selection of different application options, even with a demonstration sorting system on the stand, is presented by Gabriel-Chemie in Düsseldorf together with the partners ALPLA and Wittmann Battenfeld (hall 15, booth C06).

An integral part of the Gabriel-Chemie autumn presentations is the colour concept COLOUR VISION no. 20. The topics focus on Sustainability and Spirituality. Both motives are more present than ever and unite the promotion of actual principles of responsible use and also the considerate handling of resources, as well as the careful and conscious handling of oneself and its surroundings.

The associated colours and materials of the COLOUR VISION Sustainability range follow these principles and showcase dry colour and surface impressions. These were realised on the basis of PCR and PIR polymers. Furthermore, new additives have been used which, among other features, enable detectability in the recycling stream. The already mentioned detectability in the recycling stream refers to a professional solution for near-infrared-detectable and sortable thermoplastic masterbatch colours. The masterbatch is made by using special pigment formulations which

enable the correspondent sorting and recycling, is food contact approved and even laser markable. The masterbatch can be extruded, blown or moulded by injection, compression, etc. Interested customers and visitors will get detailed information and can convince themselves of the application functionality.

A laser additive masterbatch enables the contact-free, permanent marking, labelling and decoration of plastic parts without using any printing ink or solvents. A marking can be made on soft, coarse, stepped and curved surfaces and is abrasion-resistant, resistant to chemicals and lightfast. The use of laser additive masterbatch makes it possible to create customised designs and personalised markings and is perfectly suited to complex and rapidly changing layouts and this makes it the most sustainable alternative to all conventional methods of customisation.

Therefore Gabriel-Chemie continues to build on its' close cooperation with beLaser® and will demonstrate the partnership at the K in the form of a separate laser area.



**K 2019: Hall 5, Booth B40**

**Gabriel-Chemie Gesellschaft m.b.H.**  
gabriel-chemie.com/events/K2019

# New Form/Cut/Stack Thermoformer

GN Thermoforming Equipment, a leading manufacturer of servo-driven, roll-fed thermoforming machines for the production of plastic packaging, will launch its new GN580 Thermoformer at the K 2019 exhibition in Düsseldorf, Germany. The new form/cut/stack thermoformer is ideal for food, medical, and industrial packaging markets.

The GN580 Thermoformer is a smaller version of the company's highly regarded GN800 launched at K 2016. The launch of the new GN models, part of GN's strategic growth plans, has proven to be very successful, according to Jerome Romkey, President of GN Thermoforming Equipment. "Our customers have fully embraced the new products and the GN800 is regarded as a highly productive and reliable machine within the industry," said Romkey. "We continue to provide an industry-leading level of service and support, giving customers added confidence when launching new machines like the GN580."

At K 2019, the GN580 will run 100% post-consumer recycled (PCR) PET with a common-edge tool, producing meat trays with minimal scrap. Over the years, GN has perfected the common-edge-cut tooling technology for their line of thermoformers. Common-edge tooling offers the ability to form a series of square or rectangular trays in a row or multiple rows while eliminating the web between the products.

The GN580 that will be exhibited during the K show has already been sold to a Central European packaging manufacturer for the production of food trays and blister packs, according to GN.

The high-production GN580 thermoformer with integrated steel rule cutting press and stacking station is used for the cost-effective manufacturing of packaging products made from all thermoformable materials. The most distinctive features of the GN580 are the high degree of automation as well as the ease of tool change.

The GN580 has a forming area of 580 x 465 mm and a cycle time of 45 cycles/min at full stroke. The machine forms 120 mm (4.7-in) deep parts above and below the sheet line. It also features an operator-friendly HMI with integrated diagnostics and remote connection, an energy recovery



system incorporated in all drives, and maintenance-free precision roller bearings in the toggles.

"While the GN580 offers many of the same features as our highly successful GN800, it is well suited for unique production runs and has a smaller footprint for factories where space is a challenge," said Paul Phillips, GN sales and marketing manager.

The GN580 offers additional options suited to specific customers' requirements and it can be further customized for certain applications. The thermoformer provides additional flexibility by accepting tools from many of the competitors' machines.

GN's family of thermoformers continues to offer advanced technology while being flexible and user-friendly. "We listen to our customers as we develop new equipment to satisfy their requirements whether they supply packaging for the food, medical, or industrial markets," said Phillips.

Among the top priorities of GN's customer-focused approach are improving productivity and ensuring that customers produce the most finished parts per pound of sheet.



K 2019: Hall 3, Booth A36

GN Thermoforming Equipment  
www.gncanada.com



# Multilayer Blow Molding Machines and Technical Products

RIKUTEC Group, a leading blow molding technology specialist, will showcase its high-precision, multilayer blow molding machines as well as high-quality, fast-cooling molds, and a range of technical blow molded products at the K 2019 exhibition in Düsseldorf, Germany.

RIKUTEC pursues a holistic approach with regard to products and services, utilizing its vast technology expertise and decades of manufacturing know-how, according to Stefan Eichelhardt, Director of RIKUTEC's Engineering Business Unit. "Our customers value us as a full-service provider, explained Eichelhardt. "We cover the entire value chain, from the production of raw materials, machinery and plant engineering to product design and series production of large-volume plastic containers. In addition, we offer our customers services covering all aspects of our broad product portfolio."

RIKUTEC will highlight the industrial packaging industry's first all-plastic Twin Drum which meets the highly stringent demands of the Packaging Group 1 regulations as specified by the ADR European agency for safe storage and transport of highly aggressive chemicals. The blow molded "tank in a tank," which offers by design secondary containment, also meets UN-sanctioned approvals in Europe and U.S. Department of Transportation regulations. The 200-liter Twin Drum effectively stores and transports highly aggressive chemicals in an ultra-clean environment for a range of industrial markets including the pharmaceutical and semiconductor industries. RIKUTEC's patented multilayer coextrusion blow molding technology manufactures products from 100 to 10,000-L in one shot.

The company will also discuss its latest effort to tackle the plastic waste issue with the development of highly sustainable materials. Depending on the application and customer requirements, RIKUTEC can use up to 100% HDPE recyclate for the production of blow molded products. When recycled incoming goods are used and are to be included in production, the raw material consists of 100% post-consumer waste. RIKUTEC produces material not only for its own use but also supplies the market with HDPE pellets for pipe and sheet extrusion; blow molded drums, containers, and tanks; and for injection molded articles.

"The circular economy is and will remain the topic of the future," said Bodo Richter, CEO and Owner of the RIKUTEC Group. "Many external factors are currently affecting the plastics industry – we, as manufacturers of machines and HDPE products manufactured by blow



molding, are trying to help shape the sustainable change in the plastics industry." Not only is generally recycled plastic used in production, but customers' rejects are also returned to the product cycle as high-quality regranulate, with properties that are comparable to virgin plastics in terms of stability.

RIKUTEC manufactures industrial packaging such as intermediate bulk containers (IBC) for storage of high-purity and sensitive liquids. It also produces large-volume container series for the environmental sector, such as containers for rainwater utilization or liquid energy sources. RIKUTEC's custom molding operation includes containers and tanks that meet special customer requirements.



K 2019: Hall 14, Booth B13

RIKUTEC Group  
www.rikutec.com

# formnext

International exhibition and conference  
on the next generation of manufacturing technologies

Frankfurt, Germany, 19 – 22 November 2019  
formnext.com

## The entire world of additive manufacturing

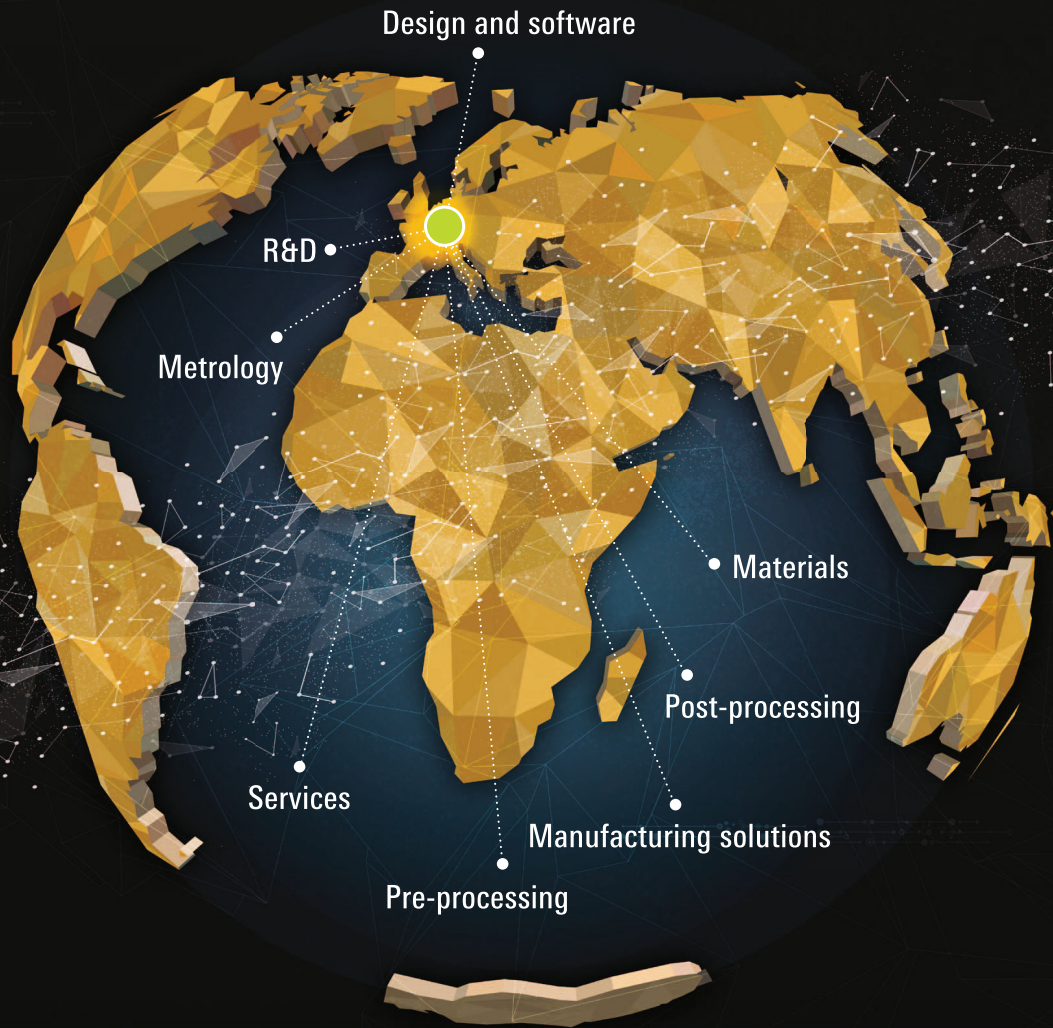

Additive manufacturing surrounds a whole world of processes.  
Instead of a world tour you only need one ticket – for Formnext!

**Where ideas take shape.**



Official event hashtag #formnext

**mesago**  
Messe Frankfurt Group



*a Family Company  
since 1957, made in Italy*

*26 years*

in designing and manufacturing high quality **gearboxes** for  
corotating and counter-rotating **twin screw extruders**

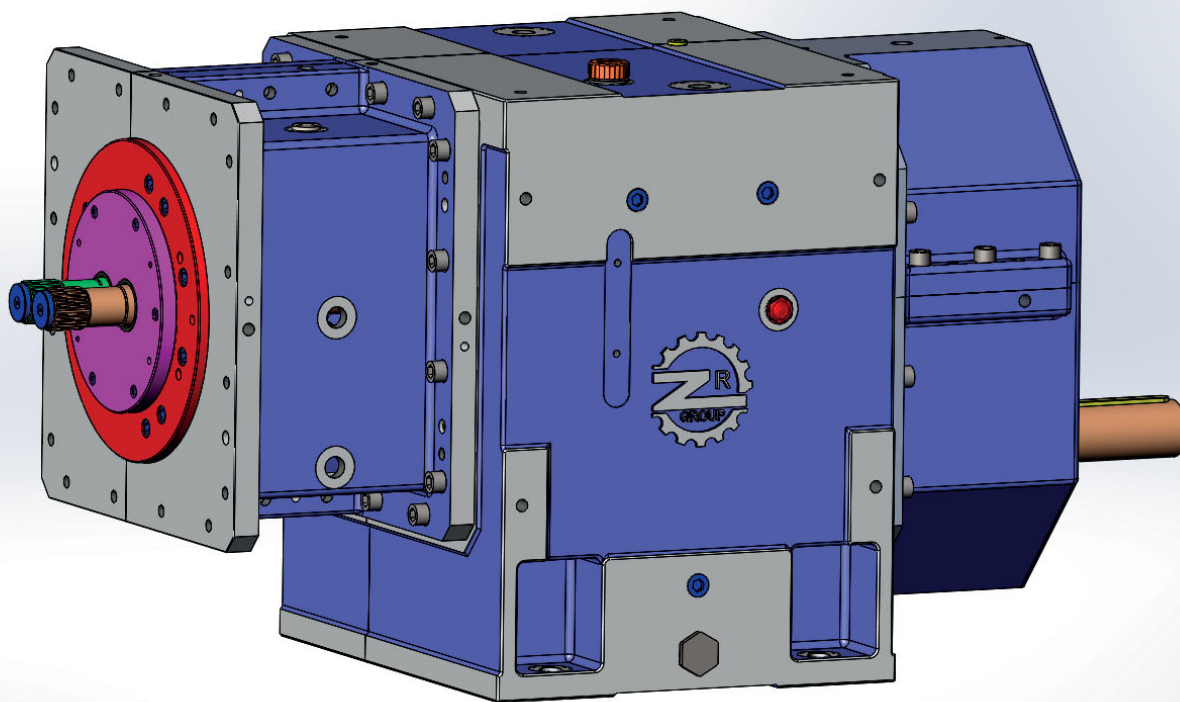

***Corotating TST type. Beware of imitations***

**Zambello riduttori srl**

Headquarters - 20020 Magnago, MI - Italy  
info@zambello.it

**Zambello riduttori 2 srl**

45026 Lendinara, RO - Italy  
info@zambello2.it

**Zamec srl**

45026 Lendinara, RO - Italy  
zamec@zambello2.it

**ZAMBELLO** group

Advanced technology for extruders

[www.zambello.com](http://www.zambello.com)